

# INSTRUCTION MANUAL

## 700120P

### EN1000/EN1001 SERIES CONTROLS

MICROPROCESSOR BASED  
Weld Sequence Controls  
With  
Solid State Thyristor Contactors

#### **INCLUDES:**

Appendix E – EN1000/EN1001 Bench Controls  
Appendix F – EN1003 Controls

<b>Cabinet Style</b>	<b>Wiring Diagrams</b>	
	<b>EN1000</b>	<b>EN1001</b>
S	421180	421270
T/D/LS/LF/FP	421210	421269
E	421212	421268
D/T	421387	421377
C	421498	421499
IMU	421424	421423

Intended for use with firmware versions 619016-002Z and higher

# **ENTRON**

**ENTRON Controls, LLC.**  
601 High Tech Court  
Greer, South Carolina 29650  
(864) 416-0190  
FAX: (864) 416-0195  
[www.entroncontrols.com](http://www.entroncontrols.com)

**RWMA**<sup>®</sup>  
MEMBER

THIS PAGE IS  
INTENTIONALLY  
BLANK

# ENTRON Controls, LLC.

MICROPROCESSOR BASED WELDING CONTROLS

INSTALLATION AND OPERATION MANUAL FOR:  
Model Series EN1000/EN1001  
NEMA Type: ALL

<b>!</b> <b>CAUTION</b> <b>!</b>
READ THIS MANUAL COMPLETELY BEFORE ATTEMPTING TO INSTALL OR OPERATE THIS CONTROL



ENTRON Controls, LLC., reserves the right to alter the contents of this manual without previous notice.

ENTRON Controls, LLC.  
Greer, South Carolina 29650

# TABLE OF CONTENTS

1.0	GENERAL DESCRIPTION .....	9
1.1	STANDARD FEATURES .....	10
1.2	CONTROL PANEL LAYOUT .....	11
2.0	PROGRAMMABLE FUNCTIONS .....	12
2.1	CONTROL FUNCTIONS .....	12
2.2	SEQUENCE TIMED PARAMETERS .....	14
2.3	OTHER PROGRAMMABLE SEQUENCE PARAMETERS .....	15
3.0	INSTALLATION .....	17
3.1	INSTALLATION AND MOUNTING DIAGRAMS – “S” CABINET .....	17
3.2	INSTALLATION AND MOUNTING DIAGRAMS – “E” CABINET .....	18
3.3	INSTALLATION AND MOUNTING DIAGRAMS – “T/D” AND “L” CABINET .....	19
3.4	INSTALLATION AND MOUNTING DIAGRAMS – “C” CABINET .....	20
3.5	INSTALLATION AND MOUNTING DIAGRAMS – FLAT PLATE AND IMU .....	21
3.6	WELDING TRANSFORMER PRIMARY WIRING .....	23
3.7	EXTERNAL SCR CONTACTOR WIRING .....	23
3.8	CONTACTOR SPECIFICATIONS .....	25
3.9	COOLING REQUIREMENTS FOR CONTACTORS .....	27
4.0	GENERAL OPERATING REQUIREMENTS .....	28
4.1	OPERATING VOLTAGE .....	28
4.2	FUSING AND SAFE OPERATION .....	30
4.3	TERMINAL STRIP DIAGRAMS AND CONNECTIONS .....	31
4.3.1	TERMINAL STRIP TS1/PCB2 .....	31
4.3.2	TERMINAL STRIP CONNECTIONS .....	33
4.3.3	TERMINAL STRIP TS1 INSIDE THE CABINET .....	35
4.4	INITIATION .....	36
4.4.1	SINGLE STAGE PILOT INITIATION .....	36
4.4.2	TWO STAGE PILOT INITIATION .....	36
4.5	OTHER TERMINAL STRIP INPUTS .....	36
4.6	NON-VOLATILE MEMORY ERROR .....	38
4.7	ISOLATION CIRCUITRY DESCRIPTION .....	40
5.0	INTRODUCTION TO DATA PROGRAMMING .....	42
5.1	GENERAL PROGRAMMING .....	42
5.2	PROGRAM LOCKOUT OPTIONS .....	43
5.2.1	PROGRAM LOCKOUT KEY SWITCH OPTION .....	43
5.2.2	USING PROGRAM LOCKOUT KEY SWITCH FOR ERROR CLEARING .....	43
5.3	SEQUENCE (SCHEDULE) PARAMETERS PROGRAMMING .....	44
5.3.1	USING PROGRAMMING SHORTCUTS .....	45
5.4	EXTENDED FUNCTIONS .....	46
5.4.1	IDENTIFICATION NUMBER .....	47
5.4.2	SEAM WELDING MODE .....	47
5.4.3	SCHEDULE SELECT .....	50
5.4.4	AUTOMATIC VOLTAGE COMPENSATION AND MONITORING .....	57
5.4.5	CLEAR ALL FUNCTIONS .....	59
5.4.6	BACK-STEP / TEMPERATURE LIMIT SWITCH .....	60
5.4.7	PROCESS OUTPUTS .....	61
5.4.8	BEAT OPERATION INITIATION MODES .....	66
5.4.9	87° DELAY .....	68
5.4.10	MANUAL POWER FACTOR PROGRAMMING .....	69
5.4.11	POWER FACTOR MEASURING .....	69
5.4.12	SQUEEZE DELAY .....	70
5.4.13	BLOCKING DELAY .....	70
5.4.14	TURNS RATIO .....	70
5.4.15	CONSTANT CURRENT MODES .....	71
5.4.16	RANGE .....	72
5.4.17	CURRENT OFFSET .....	73
5.4.18	PIN LOCKOUT MODE .....	76

## TABLE OF CONTENTS (cont.)

6.0	GENERAL OPERATING INSTRUCTIONS .....	77
6.1	WELD SEQUENCE EXAMPLE .....	77
6.2	CYCLE MODES .....	78
6.2.1	NON-REPEAT .....	78
6.2.2	REPEAT .....	79
6.2.3	CHAINED .....	79
6.2.4	SUCCESSIVE .....	81
6.2.5	CONDITIONAL SUCCESSIVE .....	82
6.2.6	WAIT-HERE .....	83
6.3	SLOPE MODES .....	84
6.3.1	NO SLOPE .....	85
6.3.2	UPSLOPE .....	85
6.3.3	DOWNSLOPE .....	85
6.4	VALVE MODES .....	86
7.0	STEPPER ON EN1000/EN1001 SERIES CONTROLS .....	87
7.1	SCHEDULE MAP .....	88
7.2	STEPPER PROGRAMMING .....	89
7.2.1	EXTENDED FUNCTION PROGRAMMING .....	89
7.2.2	WELD SEQUENCE PROGRAMMING .....	89
7.2.3	STEP COUNTS PROGRAMMING .....	89
7.2.4	LAST STEP AND LAST COUNT PROGRAMMING .....	90
7.2.5	QUICK SETUP INSTRUCTIONS FOR STEPPER .....	91
7.3	SEQUENCE (SCHEDULE) INITIATION IN STEPPER MODE .....	92
7.3.1	SCHEDULE SELECT OPTIONS FOR STEPPER MODE <i>S.t.=01</i> .....	92
7.3.2	SCHEDULE SELECT OPTIONS FOR STEPPER MODE <i>S.t.=02</i> .....	92
7.4	STEPPER OPERATION .....	93
7.4.1	OPERATION ALGORITHM FOR STEPPER MODE <i>S.t.=01</i> .....	93
7.4.2	STEPPER OPERATION FOR STEPPER MODE <i>S.t.=02</i> .....	94
7.5	STEPPER RESET .....	95
7.5.1	MANUAL STEPPER RESET .....	95
7.5.2	AUTOMATIC STEPPER RESET .....	95
7.5.3	STEPPER RESET USING EXTERNAL SWITCH INPUT .....	96
7.6	USING STEPPER AS A COUNTER .....	96
7.7	DISPLAYING STEPPER COUNT DURING OPERATION .....	96
7.8	END OF STEPPER .....	96
8.0	CONSTANT CURRENT OPERATION (EN1001 only) .....	97
8.1	HARDWARE SETUP .....	97
8.2	SOFTWARE PARAMETERS SETUP .....	98
8.2.1	SECONDARY PRESET-RANGE COMPENSATION OR MONITORING MODE WITH ROGOWSKI COIL .....	99
8.2.2	PRIMARY PRESET-RANGE COMPENSATION OR MONITORING MODE WITH CURRENT TRANSFORMER .....	99
8.2.3	SECONDARY AUTO-RANGE COMPENSATION OR MONITORING MODE WITH ROGOWSKI COIL .....	100
8.2.4	PRIMARY AUTO-RANGE COMPENSATION OR MONITORING MODE WITH CURRENT TRANSFORMER .....	100
8.3	DISPLAYING CURRENT AFTER WELD SEQUENCE .....	101
8.3.1	USING CONSTANT CURRENT PROCESS OUTPUTS .....	102
8.3.2	SETTING LIMIT WINDOW FOR CONSTANT CURRENT .....	103
8.4	LEARNING-TYPE SETUP PROCESS FOR AUTO-RANGE WORKING MODE .....	103
8.4.1	SETTING UP CURRENT REGULATOR .....	104
8.4.2	SETTING UP CURRENT REGULATOR – BOARDS W/PROMS BEFORE 619016-001R .....	105
9.0	APPLICATIONS AND PROGRAMMING EXAMPLES .....	106
9.1	SPOT MODE EXAMPLES .....	106
9.1.1	SPOT WITH REPEAT MODE .....	106
9.1.2	PULSATION WITH SUCCESSIVE MODE .....	106
9.1.3	QUENCH-TEMPER WITH CHAINED MODE .....	107

## TABLE OF CONTENTS (cont.)

9.1.4	UPSLOPE AND DOWNSLOPE WITH CHAINED MODE .....	107
9.1.5	BUTT WELD WITH CHAINED MODE .....	108
9.1.6	FORGE DELAY WITH CHAINED MODE .....	108
9.2	SEAM MODE EXAMPLES .....	110
9.2.1	CONTINUOUS SEAM MODE .....	110
9.2.2	INTERMITTENT SEAM MODE .....	110
9.2.3	WELD CURRENT DELAY .....	110
9.2.4	SEAM MODE <b>5.E=06</b> .....	111
9.3	BRAZING APPLICATION .....	112
9.3.1	AUTOMATIC BRAZING MODE .....	112
9.3.2	MANUAL BRAZING MODE .....	112
9.4	SQUEEZE DELAY APPLICATION .....	113
9.4.1	SQUEEZE DELAY OPERATION .....	113
9.4.2	SQUEEZE DELAY PROGRAMMING .....	113
9.5	RETRACTION APPLICATION .....	114
9.5.1	MOMENTARY CLOSURE .....	114
9.5.2	MAINTAINED CLOSURE .....	115
9.5.3	AIR OVER OIL RETRACTION .....	117
9.6	MULTIPLE SCHEDULE OPERATION .....	122
9.7	PROCESS OUTPUT <b>26</b> .....	123
9.7.1	VALVE 1 – WELDING HEAD SOLENOID OUTPUT FOR ELECTRODES .....	123
9.7.2	VALVE 2 – MAGNETIC ISOLATION CONTACTOR OUTPUT CR1 .....	124
9.7.3	VALVE 3 – ALARM OUTPUT CR2 .....	124
9.8	HALF CYCLE CURRENT MONITORING .....	125
9.8.1	ENABLE HALF CYCLE WELDING .....	125
9.8.2	PROGRAM A HALF CYCLE WELD .....	125
9.8.3	ENABLE CURRENT MONITORING .....	125
10.0	OPTIONS FOR EN1000 AND EN1001 SERIES CONTROLS .....	126
10.1	MM2 MEMORY MODULE .....	126
10.2	INTEGRATED PRESSURE SENSE AND CONTROL SYSTEM .....	126
10.3	24 VDC VALVE OUTPUTS .....	127
10.4	CURRENT SENSORS .....	127
10.5	PROGRAM LOCKOUT KEY SWITCH .....	127
10.6	1 OF 7 VALVE EXTENSION BOARD .....	127
10.7	SCHEDULE SELECT S49 OPTION .....	127
10.8	RS485 OPTIONS .....	127
10.9	ENLINK 1000/1001 SOFTWARE .....	128
10.10	REMOTE TERMINAL RT4jr .....	128
10.11	ISOLATED ADAPTERS – S485 AND U485 .....	128
10.12	RS232 OPTIONS .....	128
10.13	HALF-CYCLE OPTION .....	128
11.0	ERROR CODES AND TROUBLESHOOTING .....	129
11.1	ERROR CODES .....	129
11.2	TROUBLESHOOTING .....	131
11.3	TROUBLESHOOTING GUIDE .....	134
11.4	WELD CONTROL WITH OPTIONS BLOCK DIAGRAM .....	136
12.0	WARRANTY AND SERVICE .....	137
<b>APPENDICES</b>		
APPENDIX A	ERROR CODES .....	138
APPENDIX B	PROGRAMMING AND SETUP .....	139
APPENDIX C	S49 SCHEDULE SELECT OPTION INSTALLATION .....	146
APPENDIX D	WELDSAFE 5000 .....	149
APPENDIX E	EN1000/EN1001 BENCH CONTROLS .....	154
APPENDIX F	EN1003 THREE PHASE DC CONTROLS .....	158
APPENDIX G	EN1000 SERIES RESPONSE TIMES .....	161
APPENDIX H	IMU MOUNTING OPTIONS .....	162

# TABLE OF CONTENTS (cont.)

## FIGURES

FIGURE 1-1	EN1000/EN1001 SYSTEM .....	9
FIGURE 1-2	CONTROL PANEL LAYOUT .....	11
FIGURE 3-1	INSTALLATION AND MOUNTING DIAGRAMS FOR STYLE "S" CABINET .....	17
FIGURE 3-2	INSTALLATION OF STYLE "E" CABINET – 300A & 1200A CONTACTOR .....	18
FIGURE 3-3	INSTALLATION OF STYLE "E" CABINET – 1800/2200/3200A CONTACTOR .....	18
FIGURE 3-4	MECHANICAL MOUNTING DIAGRAM FOR "E" CABINET .....	18
FIGURE 3-5	INSTALLATION OF STYLE "T/D" & "L" CABINETS – 1200A CONTACTOR .....	19
FIGURE 3-6	INSTALLATION OF STYLE "T/D" & "L" CABINETS – 1800/2200/3200A CONTACTOR .....	19
FIGURE 3-7	MECHANICAL MOUNTING DIAGRAM FOR "T/D" AND "L" CABINETS .....	19
FIGURE 3-8	INSTALLATION DIAGRAM FOR STYLE "C" CABINET .....	20
FIGURE 3-9	MOUNTING DIAGRAMS FOR STYLE "C" CABINET .....	20
FIGURE 3-10	INSTALLATION AND MOUNTING DIAGRAMS FOR 11x11 FLAT PLATE .....	21
FIGURE 3-11	INSTALLATION AND MOUNTING DIAGRAMS FOR 21x21 FLAT PLATE .....	21
FIGURE 3-12	INSTALLATION AND MOUNTING DIAGRAMS FOR 13x19 FLAT PLATE .....	22
FIGURE 3-13	INSTALLATION AND MOUNTING DIAGRAMS FOR IMU .....	22
FIGURE 3-14	EXTERNAL SCR CONTACTOR CONNECTIONS .....	24
FIGURE 3-15	DEMAND CURRENT VS. PERCENT DUTY CYCLE .....	26
FIGURE 4-1	VOLTAGE OPERATION JUMPERS SETTINGS .....	28
FIGURE 4-2	VALVE TRANSFORMER JUMPERS SETTINGS .....	29
FIGURE 4-3	WARNING, DANGER AND CAUTION LABELS .....	30
FIGURE 4-4	TERMINAL STRIP/FIRING BOARD .....	31
FIGURE 4-5	COMPONENT PLACEMENT ON NEW TERMINAL STRIP/FIRING BOARD .....	32
FIGURE 4-6	TERMINAL STRIP FOR "T/D" CABINET .....	35
FIGURE 4-7	INITIATION INPUTS ON TERMINAL STRIP TS1 .....	36
FIGURE 4-8	OTHER INPUTS ON TERMINAL STRIP TS1 .....	37
FIGURE 4-9	FLASHING <del>14</del> OR <del>32</del> ERRORS .....	38
FIGURE 4-10	WRONG ROUTING OF LOW AND HIGH VOLTAGE WIRES .....	39
FIGURE 4-11	BETTER ROUTING OF LOW AND HIGH VOLTAGE WIRES .....	39
FIGURE 4-12	RECOMMENDED ROUTING OF LOW AND HIGH VOLTAGE WIRES .....	39
FIGURE 4-13	ISOLATION CIRCUIT BLOCK DIAGRAM .....	40
FIGURE 5-1	FOUR-DIGIT DATA DISPLAY .....	42
FIGURE 5-2	COPY SCHEDULE UP BY 1 .....	45
FIGURE 5-3	COPY SCHEDULE UP BY 10 .....	45
FIGURE 5-4	CLEAR SCHEDULE DATA .....	45
FIGURE 5-5	SELECTING FUNCTIONS .....	46
FIGURE 5-6	EXTENDED FUNCTIONS MODE .....	46
FIGURE 5-7	VIEWING EXTENDED FUNCTIONS .....	46
FIGURE 5-8	DUAL TWO-STAGE FOOT SWITCH INITIATION .....	52
FIGURE 5-9	MULTIPLE TWO-STAGE FOOT SWITCH INITIATION .....	52
FIGURE 5-10	ANTI-TIE DOWN CONNECTIONS .....	52
FIGURE 5-11	SINGLE CONTACT AND ANTI-TIE DOWN INITIATIONS .....	53
FIGURE 5-12	SWITCH CLOSURE CONNECTIONS .....	54
FIGURE 5-13	MULTIPLE PILOT SWITCH CONNECTIONS .....	55
FIGURE 5-14	CLEAR SCHEDULE DATA .....	59
FIGURE 5-15	BACK-STEP SEQUENCE EXAMPLE .....	60
FIGURE 5-16	USING LIGHT CURTAIN .....	67
FIGURE 6-1	NON-REPEAT SEQUENCE .....	78
FIGURE 6-2	REPEAT SEQUENCE .....	79
FIGURE 6-3	CHAINED SEQUENCE .....	80
FIGURE 7-1	STEPPER ENABLING .....	87
FIGURE 7-2	SELECT WELD/HEAT .....	89
FIGURE 7-3	PROGRAM WELD COUNT .....	89
FIGURE 7-4	PROGRAM LAST STEP .....	90
FIGURE 7-5	PROGRAM LAST COUNT .....	90
FIGURE 7-6	ALGORITHM .....	93

# TABLE OF CONTENTS (cont.)

## FIGURES (cont.)

FIGURE 8-1	JUMPER SETTING: PRIMARY CURRENT TRANSFORMER .....	98
FIGURE 8-2	JUMPER SETTING: SECONDARY ROGOWSKI COIL .....	98
FIGURE 8-3	JUMPER SETTINGS .....	104
FIGURE 9-1	SPOT WITH REPEAT MODE .....	106
FIGURE 9-2	PULSATION WITH SUCCESSIVE MODE .....	106
FIGURE 9-3	QUENCH-TEMPER WITH CHAINED MODE .....	107
FIGURE 9-4	UPSLOPE AND DOWNSLOPE WITH CHAINED MODE .....	107
FIGURE 9-5	BUTT WELD WITH CHAINED MODE .....	108
FIGURE 9-6	FORGE DELAY WITH CHAINED MODE .....	109
FIGURE 9-7	CONTINUOUS SEAM MODE .....	110
FIGURE 9-8	INTERMITTENT SEAM MODE .....	110
FIGURE 9-9	NON-BEAT SEAM MODE .....	111
FIGURE 9-10	USING TWO STAGE INITIATION IN BRAZING MODE .....	112
FIGURE 9-11	SQUEEZE DELAY OPERATION .....	113
FIGURE 9-12	MOMENTARY RETRACTION CONNECTIONS .....	115
FIGURE 9-13	MAINTAINED CLOSURE RETRACTION CONNECTIONS .....	116
FIGURE 9-14	AIR OVER OIL RETRACTION CONNECTIONS .....	118
FIGURE 9-15	AIR OVER OIL RETRACTION TIMING DIAGRAMS .....	121
FIGURE 9-16	SCHEDULE SELECT .....	122
FIGURE 9-17	PROCESS OUTPUT <b>26</b> WIRING .....	123

## TABLES

TABLE 2-1	SLOPE MODES .....	15
TABLE 2-2	CYCLE MODES .....	15
TABLE 2-3	VALVE CODES .....	16
TABLE 3-1	EXTERNAL SCR CONTACTOR CONNECTIONS .....	23
TABLE 5-1	EXTERNAL SCHEDULE SELECT WITH FS7 AND FS11 .....	51
TABLE 5-2	S49 EXTERNAL SCHEDULE SELECT .....	54
TABLE 5-3	STEPPER SELECTION USING SS1, SS2, SS4, SS8 .....	55
TABLE 5-4	ORIGINAL AVC VALUES .....	57
TABLE 5-5	AVC PARAMETER VALUES .....	57
TABLE 5-6	PROCESS OUTPUT CODES AND DESCRIPTIONS .....	62
TABLE 5-7	CONSTANT CURRENT MODES .....	71
TABLE 5-8	MAXIMUM AND MINIMUM VALUES FOR <i>r.R.</i> .....	72
TABLE 6-1	VALVE CODES .....	83
TABLE 6-2	VALVE MODES AND VALVE OUTPUTS .....	86
TABLE 7-1	SCHEDULE MAP USED FOR STEPPER PROGRAMMING .....	88
TABLE 7-2	STEPPER CODES .....	89
TABLE 7-3	STEPPER SELECTION USING FS7 AND FS11 .....	92
TABLE 7-4	STEPPER SELECTION USING SS1, SS2, SS4, SS8 .....	92
TABLE 7-5	PROGRAMMING FOR STEPPER MODE <b>02</b> .....	94
TABLE 8-1	OPERATING RANGES FOR PRESET-RANGE SELECTION WITH ROGOWSKI COIL .....	99
TABLE 9-1	EXTERNAL SCHEDULE SELECT WITH FS7 AND FS11 .....	122



# 1.0 GENERAL DESCRIPTION

The EN1000/EN1001 Control is a microprocessor based welding control. It can perform Upslope, Downslope, Quench, Temper, Pulsation, Seam, and Spot, all of which can be combined to provide for any possible welding schedule imaginable. It can store as many as 11 base parameters in each of 50 unique schedules. These are held in non-volatile memory for storage. In addition, schedules can be chained together to provide more complex welding sequences. Despite the seemingly complicated possible welding schedules, both the EN1000 and EN1001 Controls are simple to program and operate.

The control provides accurate, predetermined execution of welding schedules for specific numbers of cycles upon an external command. Initiation commands can be given by the closure of a normally-open switch installed as part of the welding machine. The initiation switches need not remain closed for the duration of the weld, but must be opened after the welding interval is completed in order to re-initiate the control. After a weld has been started, the control cannot be re-initiated until the previous sequence is completed.

The EN1000 and EN1001 Controls are designed to operate in conjunction with a welding transformer rated for the 60 Hz or 50 Hz output frequency. These controls can be used either on 60 Hz or 50 Hz, without any additional settings or changing parameters. These controls are not designed to operate with mid-frequency transformers with 500 Hz to 2000 Hz operating frequency rating.

The EN1001 differs from EN1000 as it has a Constant Current mode of operation, see Section 5.4.15 and Section 8.0.

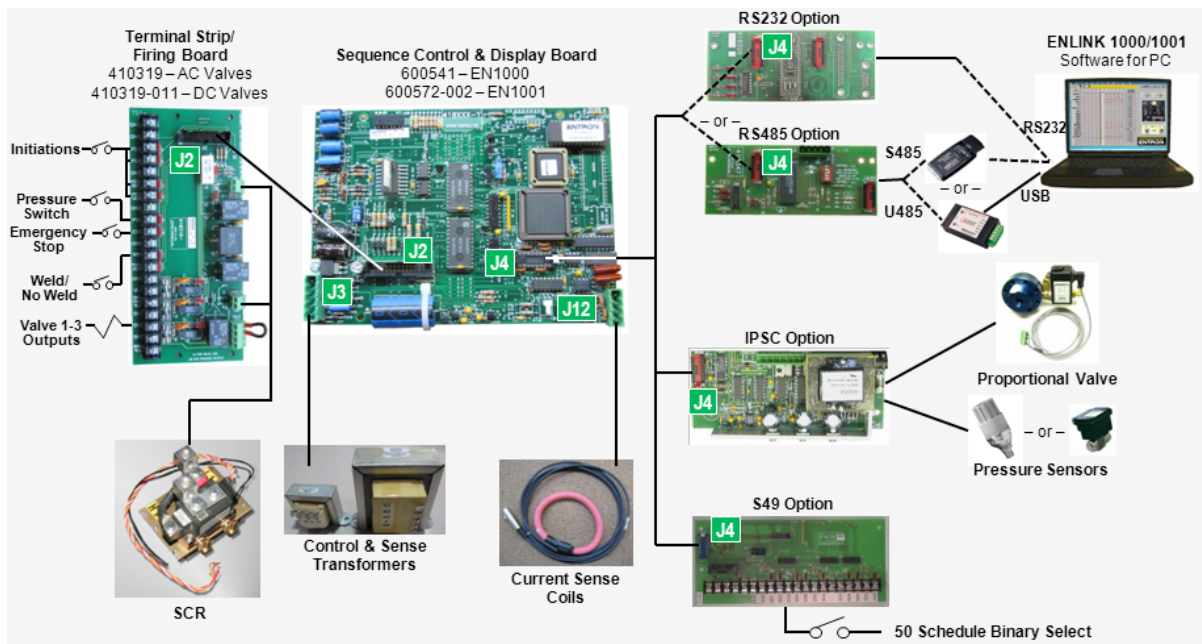


Figure 1-1. EN1000/EN1001 System

## 1.1 STANDARD FEATURES (All Models)

**DIGITAL PHASE SHIFT CURRENT CONTROL** – Varies the output waveform duty cycle from 0% to 99%, adjustable in 1% steps by means of Front Panel push buttons and direct reading LED displays.

**FUNCTION TIMING** – Control uses Front Panel push buttons and direct reading LED displays to program parameter timing in 1 cycle steps. Timing of SQUEEZE, HOLD, and OFF are achieved by counting each cycle of the line current directly. This method of timing allows this control to be used on either 50 Hz or 60 Hz power without special adjustments.

### NOTICE

**NO ADJUSTMENT** is required for timing to change from 60 to 50 Hz operation.

**OPERATING CONDITIONS** – Temperature Range: 0°C to 70°C (32°F to 158°F).

**POWER SUPPLY MONITORING** – Control monitors VCC power supply and, whenever this voltage goes below safe operating range, the message **d.o.u.n.** will be displayed on DATA display. After this condition, control must be reset by activating Emergency Stop input or by reapplying the power to the control.

**PRESSURE SWITCH FIRING** – Terminal Strip connection which allows the control to be initiated from a Pressure Switch closure. Remove the jumper from TS1-PS1 and TS1-GND and connect Pressure Switch leads. Pressure Switch is not furnished with control.

**EMERGENCY STOP** – Terminal Strip connection which allows all control functions to be reset upon opening of the Emergency Stop Switch. **After an Emergency Stop, the control will not re-initiate automatically upon release of the switch.** The control must be re-initiated through the initiation circuits. The display will be flashing **E.S.** when TS1-ES1 is open. Remove the jumper from TS1-ES1 and TS1-GND and install a normally closed switch. Emergency Stop Switch is not furnished with control.

**VALVE CONTROL TRANSFORMER** – Provides the necessary voltage for powering the welding machine solenoid valve(s). Input voltage may be either 240 VAC or 480 VAC (see Wiring Diagram). Valve transformer output is 115 VAC (optional low voltage transformer for certain operations provides a 24/48 VAC output). A 50 VA transformer is provided in “S” Cabinets, and 150 VA transformer is standard in “T/D”, “C” and NEMA enclosures (250 VA or 500 VA transformers optional).

### NOTICE

This control may be configured for external valve power. See Section 4.3 for Terminal Strip (TS1) external valve power connection.

### ! CAUTION !

When external valve power is used, 24-240 VAC or 24 VDC, valve transformer must be disconnected at TS3-VL1 and TS3-VL2. Caution must be used to properly insulate the wires from T3-X1 and T3-X2 leads after removing from TS3.

## 1.2 CONTROL PANEL LAYOUT

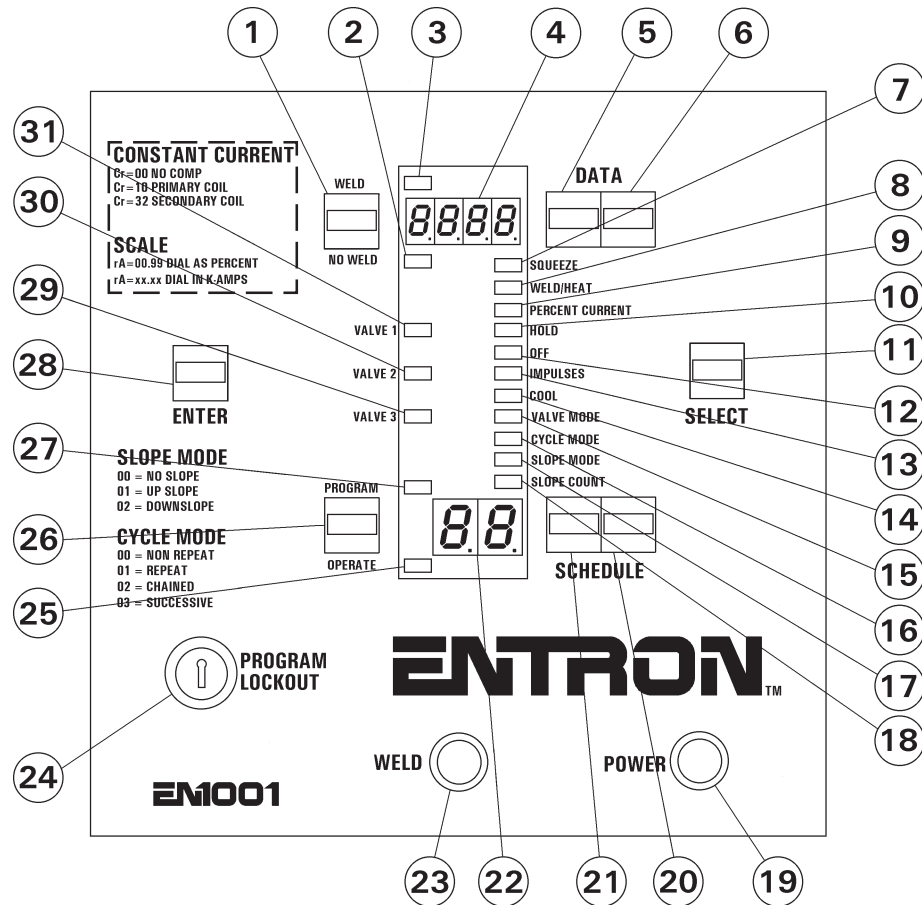


Figure 1-2. Control Panel layout

- |  |   |
|--|---|
| 1 - WELD/NO WELD push button               | 17 - SLOPE MODE function indicator LED* |
| 2 - NO WELD mode indicator LED             | 18 - SLOPE COUNT function indicator LED |
| 3 - WELD mode indicator LED                | 19 - POWER light (red)                  |
| 4 - DATA display                           | 20 - SCHEDULE 1s push button            |
| 5 - DATA 10s push button                   | 21 - SCHEDULE 10s push button           |
| 6 - DATA 1s push button                    | 22 - SCHEDULE display                   |
| 7 - SQUEEZE function indicator LED         | 23 - WELD light (white)                 |
| 8 - WELD/HEAT function indicator LED       | 24 - PROGRAM LOCKOUT key switch         |
| 9 - PERCENT CURRENT function indicator LED | 25 - OPERATE mode indicator LED         |
| 10 - HOLD function indicator LED           | 26 - PROGRAM/OPERATE push button        |
| 11 - SELECT push button                    | 27 - PROGRAM mode indicator LED         |
| 12 - OFF function indicator LED            | 28 - ENTER push button                  |
| 13 - IMPULSES function indicator LED       | 29 - VALVE 3 indicator LED              |
| 14 - COOL function indicator LED           | 30 - VALVE 2 indicator LED              |
| 15 - VALVE MODE function indicator LED     | 31 - VALVE 1 indicator LED              |
| 16 - CYCLE MODE function indicator LED*    |   |

\* For operator convenience, codes for SLOPE MODE and CYCLE MODE functions are printed on the left side of the Control Panel.

On **EN1000** Control Panel layout, there is no added text for CONSTANT CURRENT modes.

## 2.0 PROGRAMMABLE FUNCTIONS

**SCHEDULES** – The EN1000/EN1001 can store up to 50 schedules, numbered from 00 to 49. A weld sequence may include more than one schedule. A chain of schedules, for example, may be used to add a forge operation during a weld sequence, or add a quench and temper sequence to a schedule. In the simplest form, a weld schedule may include SQUEEZE, WELD, and HOLD only. In a more complex form, a schedule may include: SQUEEZE and PRESSURE or FORCE for the electrode, WELD time and STEPPER count, CURRENT in [%] or [kA] and HI/ LO CURRENT limits when using CONSTANT CURRENT mode, HOLD, etc. All of these features may be accessed by means of Front Panel parameters.

**EXTENDED FUNCTIONS** – The EXTENDED FUNCTIONS are used instead of Jumper or Dip-switch settings. They are accessible from the Front Panel by simply clicking the SELECT push button until FUNCTION indicator LED reaches SLOPE COUNT, then click once more. At this point, the top display (DATA) will show **EF**. By clicking the SCHEDULE push buttons, the EXTENDED FUNCTIONS are visible in the bottom display (SCHEDULE). For most features, such as CHAINED schedules or SUCCESSIVE initiations, it is not necessary to enable functions. For some others such as STEPPER (**5.t.**), it is necessary to just enable a Front-Panel accessible EXTENDED FUNCTION. For others, it is necessary to add optional hardware to the base control, such as the Integrated Pressure Sense Control System or Constant Current operation.

### 2.1 CONTROL FUNCTIONS – See Figure 1-2. *Control Panel layout*

**WELD/NO WELD PUSH BUTTON (1)** – This push button is active at all times. It puts the control in the WELD mode (enables the weld firing pulse) or NO WELD mode (disables firing). This function is accessible while in OPERATE mode or while welding with few exceptions (generally during error conditions).

**WELD (3)/NO WELD (2) INDICATOR LEDs** – These lights indicate the firing status of the control. The LEDs toggle whenever the WELD/NO WELD push button is pressed.

**DATA PUSH BUTTONS (5) & (6)** – The right button increments DATA display (4) by one, and the left button increments by ten. When either digit reaches the maximum, it resets to zero. For parameters which allow programming of all four digits, the right button affects the two right-hand digits – click to increment by one; press and hold to increment by ten. The left button affects the two left-hand digits – click to increment by 100; press and hold to increment by 1000. Only active in the PROGRAM mode.

**FUNCTION INDICATOR LEDs (7-10 & 12-18)** – The indicator LEDs light up to indicate the active SCHEDULE parameter. They correspond to the programmable functions listed on the Control Panel as the operator presses SELECT to view function values.

**SELECT PUSH BUTTON (11)** – Use the SELECT push button to choose any SCHEDULE parameter. As the button is pressed, the corresponding LED will light up to indicate the parameter data in the DATA display. Holding the SELECT push button momentarily will reverse the direction of the LED movement when the button is released.

## 2.1 CONTROL FUNCTIONS (cont.) – See Figure 1-2. *Control Panel layout*

**EXTENDED FUNCTIONS** – One of the features found while paging through the functions by using the SELECT push button is the EXTENDED FUNCTIONS (**EF**). The EXTENDED FUNCTIONS are a second layer of parameters that apply to all the schedules and can modify the way the control operates (see Section 5.4). To view the EXTENDED FUNCTIONS, press SELECT until all LEDs are off and DATA display shows **EF**.

**POWER LIGHT (19)** – The red POWER lamp indicates when power is applied to the control.

**WELD LIGHT (23)** – The white WELD lamp is connected directly across the welding transformer and will light when voltage is present at the welding transformer. The brilliance of the WELD light is an indication of the programmed PERCENT CURRENT and therefore provides a visual indication of the percent of RMS voltage supplied to the welding transformer.

**SCHEDULE DISPLAY (22)** – The SCHEDULE display shows the number of the active schedule. The EN1000/EN1001 can store up to 50 schedules numbered from 00 to 49.

**SCHEDULE PUSH BUTTONS (20) & (21)** – The right button increments SCHEDULE display by one, and the left button increments by ten. When either digit reaches the maximum, it resets to zero.

There are two ways to select the active schedule:

1. **INTERNAL:** Use the SCHEDULE push buttons and **select** the desired schedule. Initiation on FS3 to GND will select the schedule shown in the display (see Section 5.4.3).
2. **EXTERNAL:** Use a combination of FS7/SS1 AND FS11/SS3 to **select one of four schedules** (see Section 5.4.3).

**PROGRAM/OPERATE PUSH BUTTON (26)** – This push button will put control in PROGRAM or OPERATE mode. PROGRAM (27) and OPERATE (25) LEDs indicate which mode control is in:

PROGRAM mode is the mode in which the individual schedules can be entered or modified. Data such as WELD time, PERCENT CURRENT, VALVE select, etc., can only be changed in the PROGRAM mode.

OPERATE mode is the normal operating mode for the control. This is the only mode in which the control can be initiated for a weld. When the control is in OPERATE mode, the control is in a Ready (to initiate) state.

**PROGRAM LOCKOUT KEY SWITCH (24) (Optional)** – A PROGRAM LOCKOUT key switch can be ordered as a factory-installed option. It may also be added later by the customer, if desired. To install the key switch, remove the key switch hole-plug from the Front Panel and mount the switch using the nut and lock-washer provided. Connect the plug from the switch onto the mating 2-prong connector (J1) on the back of the Display Circuit Board.

To put the control in **PROGRAM** mode using the PROGRAM LOCKOUT key switch:

**Rotate the key 45 degrees clockwise and hold, while holding the key in this position, press and release the PROGRAM/OPERATE push button**, then release the key. The OPERATE LED will now turn off and the PROGRAM LED will turn on, indicating programmability of all functions.

## 2.1 CONTROL FUNCTIONS (cont.) – See Figure 1-2. Control Panel layout

To put the control back in the **OPERATE** mode:

Press the PROGRAM/OPERATE push button again. The control will return to the OPERATE mode without the necessity of rotating the key.

See Section 5.4.18 for detailed information on PIN LOCKOUT mode.

**ENTER PUSH BUTTON (28)** – The ENTER push button is used to **store** the data shown from the DATA display **into** the non-volatile **memory** which retains data with the power off.

### NOTICE

If ENTER is **not** pressed before other data is viewed (by pressing the SELECT push button) or before returning to the OPERATE mode, the data will not be stored; however, it is not necessary to press the ENTER push button to save the four-digit DATA display.

**VALVE INDICATOR LEDs (29, 30, & 31)** – These three LEDs indicate, in the OPERATE mode, when the solenoid valves are activated in the control program. In the PROGRAM mode, these same LEDs indicate the valve chosen for the weld sequence (schedule) being programmed. Codes for valve selection are given in Table 2-3.

## 2.2 SEQUENCE TIMED PARAMETERS (Count Functions)

SQUEEZE .....	Programmable from 0 to 99 cycles (50/60 Hz)
WELD/HEAT .....	Programmable from 0 to 99 cycles (50/60 Hz)
HOLD .....	Programmable from 0 to 99 cycles (50/60 Hz)
OFF .....	Programmable from 0 to 99 cycles (50/60 Hz)
IMPULSES .....	Programmable from 1 to 99
COOL .....	Programmable from 0 to 99 cycles (50/60 Hz)
SLOPE COUNT .....	Programmable from 0 to 99 cycles (50/60 Hz)

### NOTICE

**NO ADJUSTMENT** is required for timing to change from 60 to 50 Hz operation.

**SQUEEZE COUNT (7)** – The **time duration for the electrodes to close** on the work and build up pressure **before** WELD time begins.

**WELD/HEAT COUNT (8)** – The **time during which current will flow through the welding transformer** (during one impulse in impulse welding). It **starts after SQUEEZE** or after the closure of a Pressure Switch, whichever occurs last.

**HOLD COUNT (10)** – The **time during which the electrodes will remain in contact** with the work to allow the weld nugget to congeal. It starts **after the WELD time**.

**OFF COUNT (12)** – In the REPEAT mode, the **time duration between HOLD count and SQUEEZE count** to allow the work to be repositioned.

**COOL COUNT (14)** – The **time between heat IMPULSES** (in multiple impulse welding).

**SLOPE COUNT (18)** – The **number of additional WELD cycles** during which **PERCENT CURRENT increases or decreases** to achieve SLOPE (gradual increase or decrease in current).

## 2.3 OTHER PROGRAMMABLE SEQUENCE PARAMETERS

**IMPULSES (13)** – The **number of heat IMPULSES** that will occur in a schedule.

**PERCENT CURRENT (9)** – The **percentage of conduction time** provided to the welding transformer primary from 0 to 99%, adjustable in 1% steps. This parameter is also used to set HIGH and LOW limits in CONSTANT CURRENT mode (see Section 8.3.2).

**SLOPE MODE (17)** – Determines **direction of the ramp** with respect to programmed weld PERCENT CURRENT. See Section 6.3 for detailed information on SLOPE MODE functions.

**Table 2-1. SLOPE MODES**

SLOPE MODE	Description
00	NO SLOPE
01	UPSLOPE
02	DOWNSLOPE

**CYCLE MODE (16)** – The manner in which the control performs schedules is determined by the code programmed into this function as described in Table 2-2. See Section 6.2 for detailed information on CYCLE MODE functions.

**Table 2-2. CYCLE MODES**

CYCLE MODE	MODE	Description
00	NON-REPEAT	The control can be initiated for only one sequence (see Section 6.2.1)
01	REPEAT	After initiation, the control internally re-initiates as long as the initiation switch is maintained closed (see Section 6.2.2)
02	CHAINED	Several schedules can be chained together so that several consecutive schedules can be sequenced from one initiation (see Section 6.2.3)
03	SUCCESSIVE	Several schedules can be sequenced successively upon separate initiations (see Section 6.2.4)
04	CONDITIONAL SUCCESSIVE	Valves remain active at the end of HOLD ( <i>this is indicated by blinking HOLD indicator LED</i> ) until control is re-initiated and next schedule will be sequenced (see Section 6.2.5)
05	WAIT-HERE	After FS3 initiation, wait either in SQUEEZE or WELD-COOL or HOLD part of the sequence until control is re-initiated with FS7 or FS11 and schedule 10 or 20 will be sequenced (see Section 6.2.6)

### NOTICE

The CYCLE MODE and SLOPE MODE function codes are printed on the Control Panel, adjacent to the ENTER push button, for operator convenience.

## 2.3 OTHER PROGRAMMABLE SEQUENCE PARAMETERS (cont.)

**VALVE MODE (15)** – The three solenoid valves are activated based on the code programmed as shown in Table 2-3.

**Table 2-3.** VALVE codes

Since the VALVE codes are in binary form, valve assignments are clarified in this table.					
VALVE code	VALVE Indicator LEDs			Description	Valve Outputs on TS1
	VALVE3	VALVE2	VALVE1		
00	OFF	OFF	OFF	All valves off	None
01	OFF	OFF	ON	Valve 1 active	SV1-SV2
02	OFF	ON	OFF	Valve 2 active	SV3-SV4
03	OFF	ON	ON	Valves 1 & 2 active	SV1-SV2 & SV3-SV4
04	ON	OFF	OFF	Valve 3 active	SV5-SV6
05	ON	OFF	ON	Valves 1 & 3 active	SV1-SV2 & SV5-SV6
06	ON	ON	OFF	Valves 2 & 3 active	SV3-SV4 & SV5-SV6
07	ON	ON	ON	Valves 1, 2 & 3 active	SV1-SV2, SV3-SV4 & SV5-SV6

When in the PROGRAM mode and selection of a VALVE code is being made, the VALVE indicator LEDs (29, 30, 31) will indicate the selected valve(s). The valve output will not be energized while in PROGRAM mode.

### NOTICE

The VALVE code indicated above can be programmed for different features such as PROCESS OUTPUT (see Section 5.4.7).

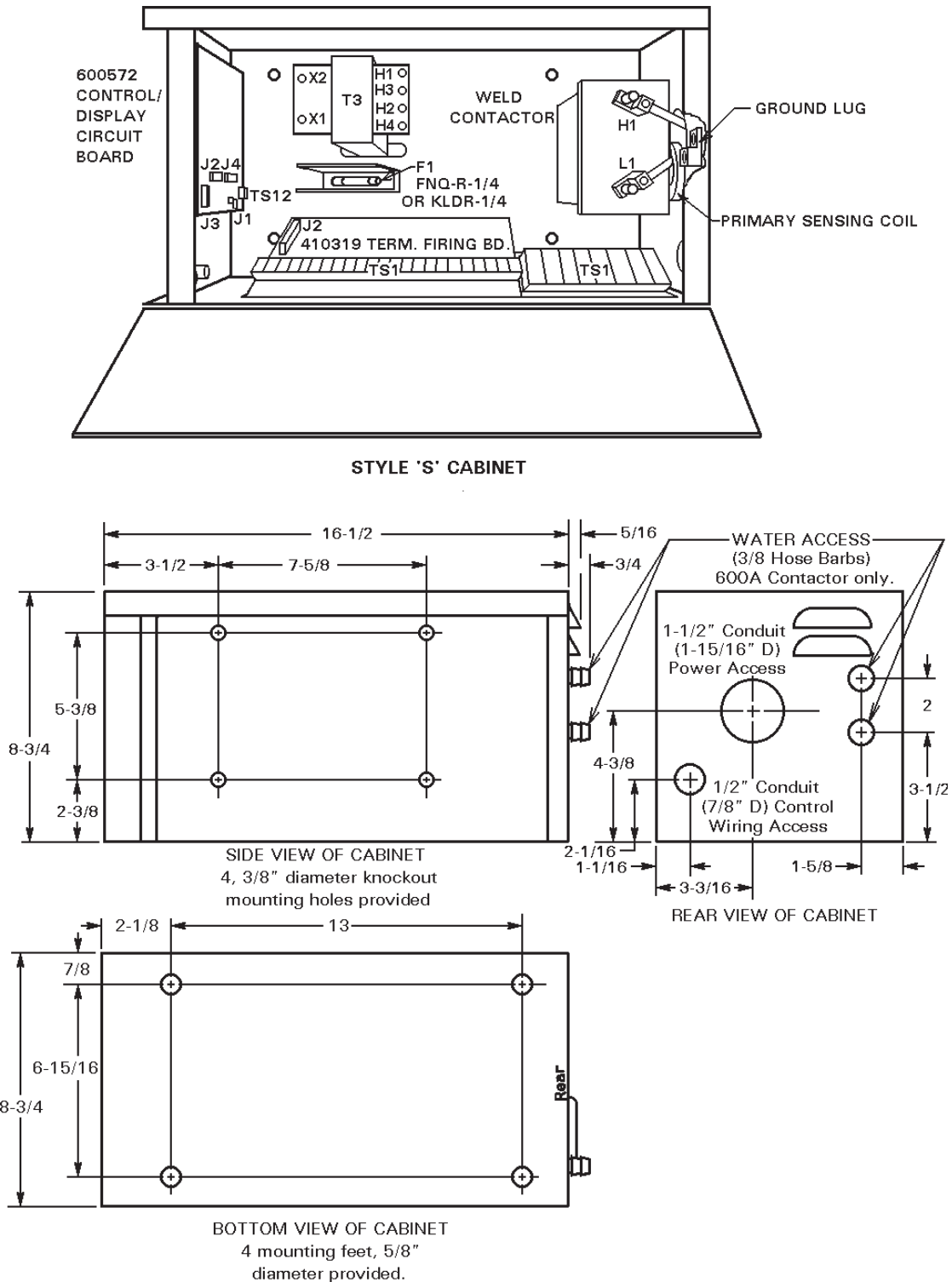


### 3.0 INSTALLATION

The EN1000 and EN1001 Series Controls can be provided in different cabinet styles.

### 3.1 INSTALLATION AND MOUNTING DIAGRAMS – “S” CABINET

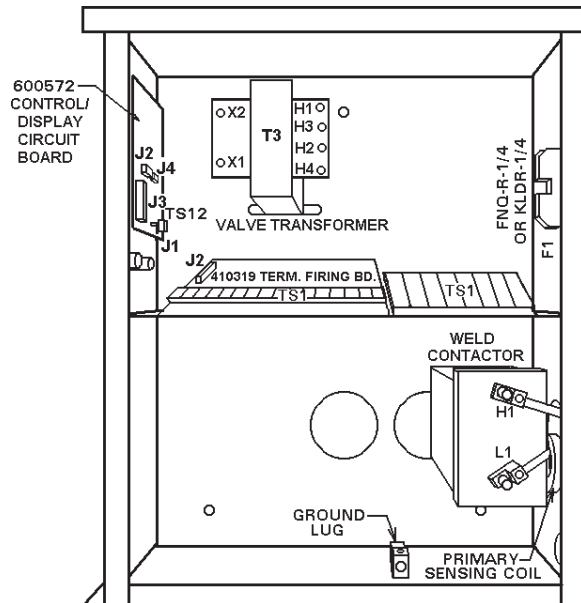
The installation and mounting diagrams for “S” Cabinet are shown in Figure 3-1. Available contactors for “S” Cabinet – 150A, 300A, and 1200A.



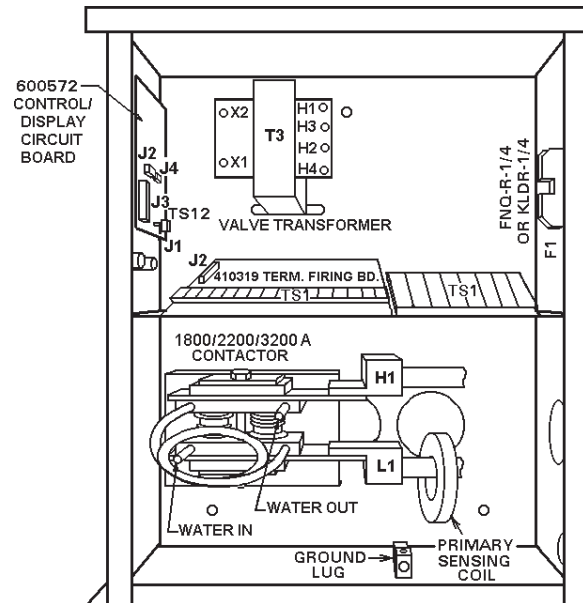
**Figure 3-1.** Installation and mounting diagrams for Style “S” Cabinet

## 3.2 INSTALLATION AND MOUNTING DIAGRAMS – “E” CABINET

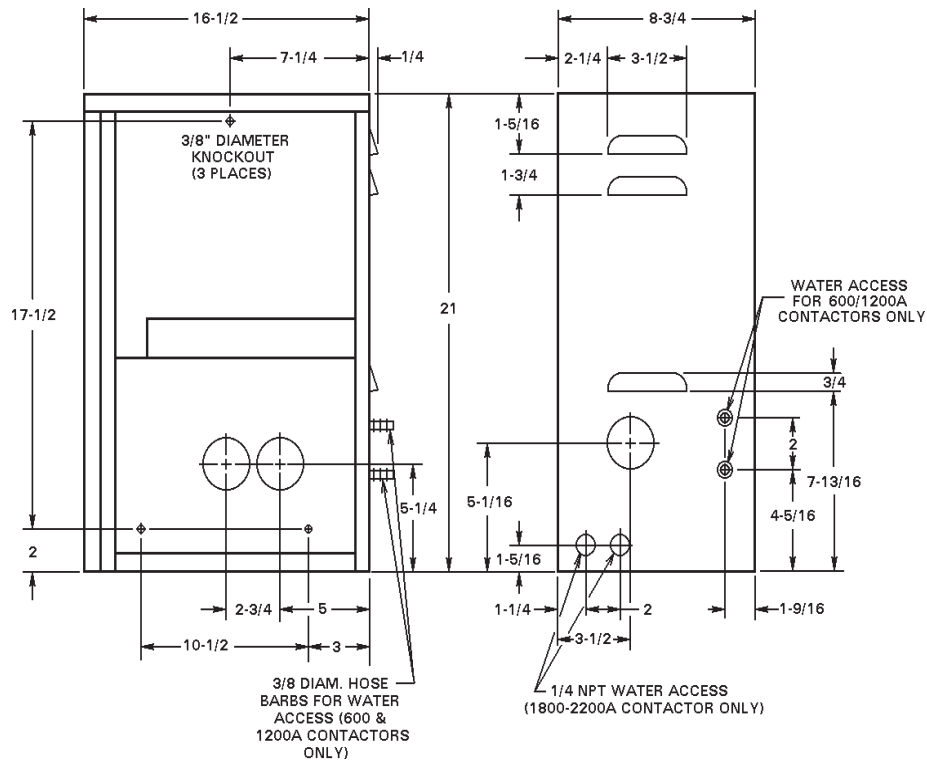
Style “E” Cabinet installation and mounting diagrams are shown in Figures 3-2, 3-3 and 3-4.



**Figure 3-2.** Installation of Style “E” Cabinet – 300A & 1200A Contactor



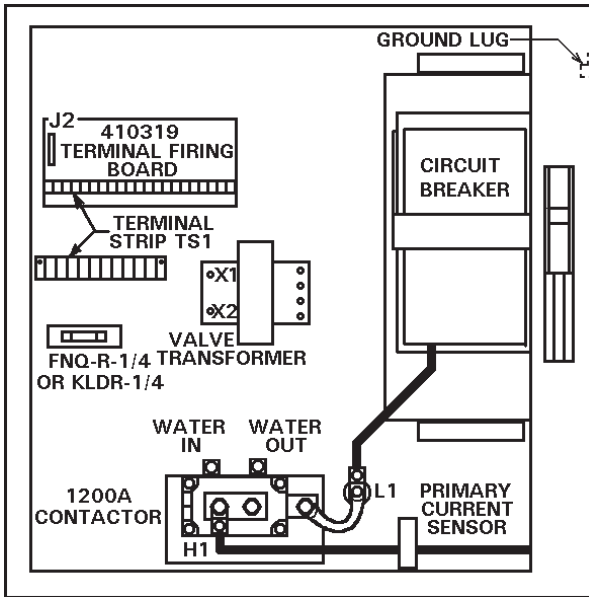
**Figure 3-3.** Installation of Style “E” Cabinet – 1800/2200/3200A Contactor



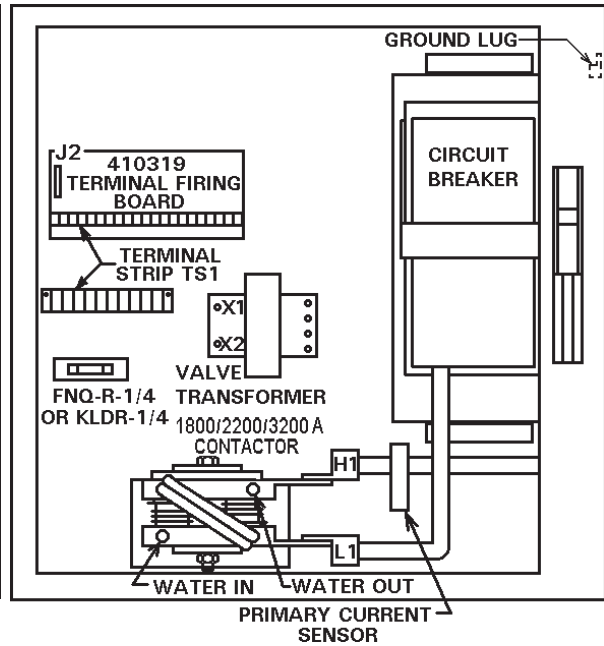
**Figure 3-4.** Mechanical mounting diagram for “E” Cabinet

### 3.3 INSTALLATION AND MOUNTING DIAGRAMS – “T/D” AND “L” CABINET

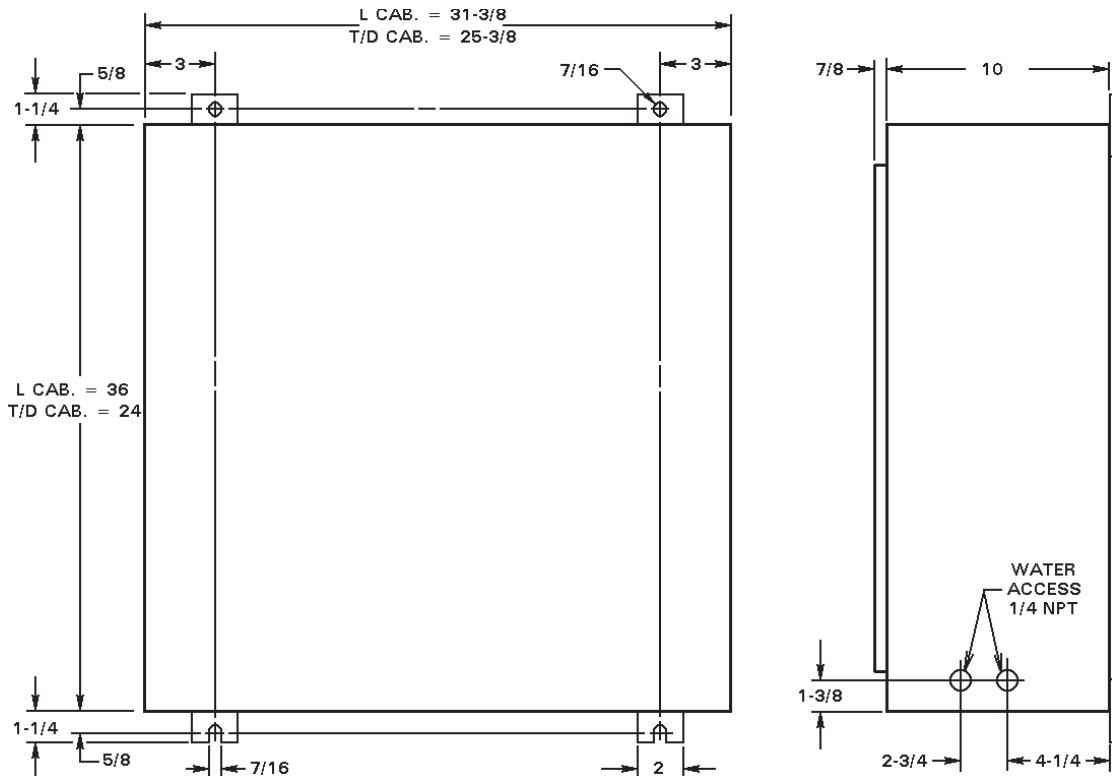
Style “T/D” and “L” Cabinet installation and mounting diagrams are shown in Figures 3-5, 3-6 and 3-7.



**Figure 3-5.** Installation of Style “T/D” and “L” Cabinets – 1200A Contactor



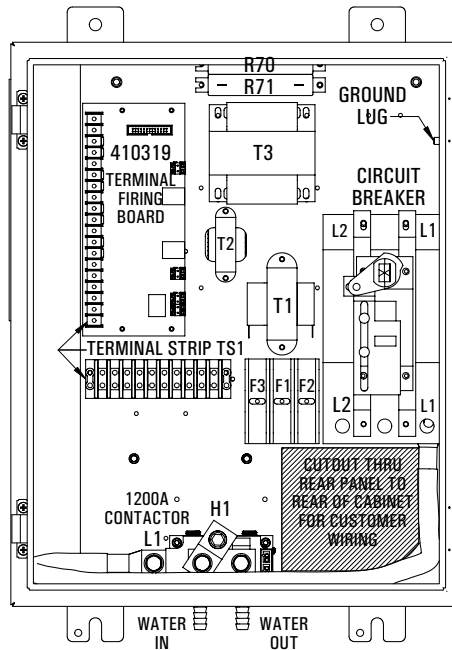
**Figure 3-6.** Installation of Style “T/D” and “L” Cabinets – 1800/2200/3200A Contactor



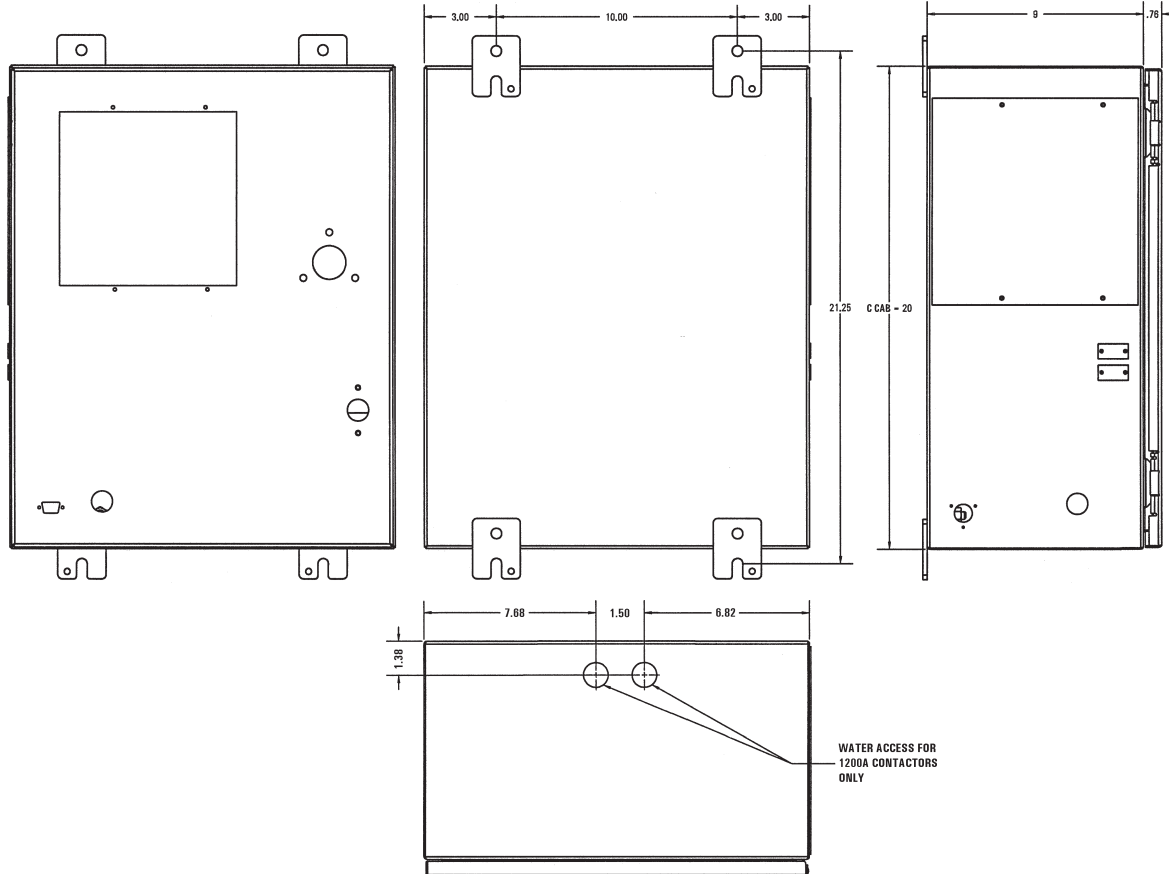
**Figure 3-7.** Mechanical mounting diagram for “T/D” and “L” Cabinets

### 3.4 INSTALLATION AND MOUNTING DIAGRAMS – “C” CABINET

Style “C” Cabinet installation and mounting diagrams are shown in Figures 3-8 and 3-9. Available contactors for “C” Cabinet – 300A and 1200A.



**Figure 3-8.** Installation diagram for Style “C” Cabinet



**Figure 3-9.** Mounting diagrams for Style “C” Cabinet

### 3.5 INSTALLATION AND MOUNTING DIAGRAMS – FLAT PLATE AND IMU

EN1000 and EN1001 Controls are available in Flat Plate (FP) and Integrated Modular Unit (IMU) component forms. Installation and mounting diagrams for these controls are shown in Figures 3-10, 3-11, 3-12, and 3-13.

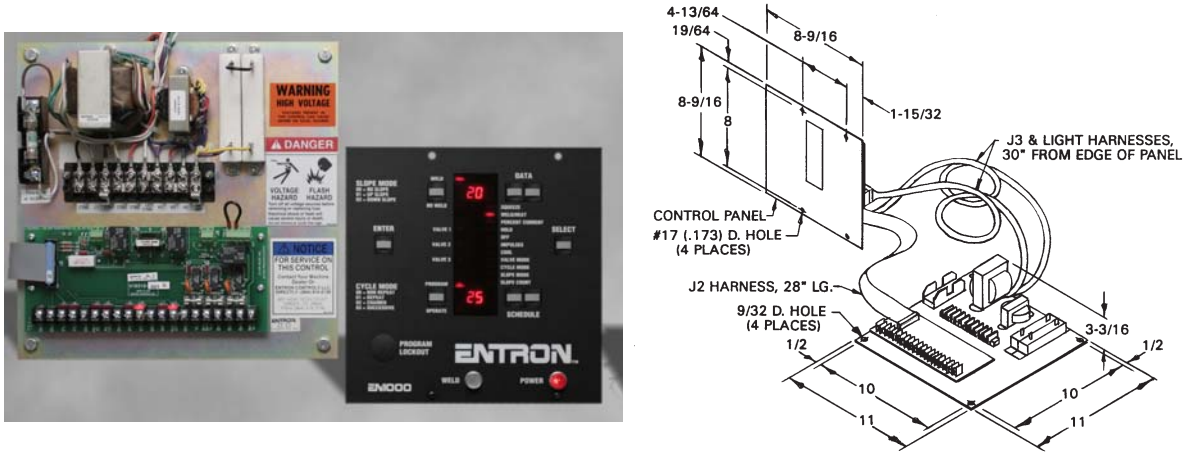


Figure 3-10. Installation and mounting for 11x11 Flat Plate

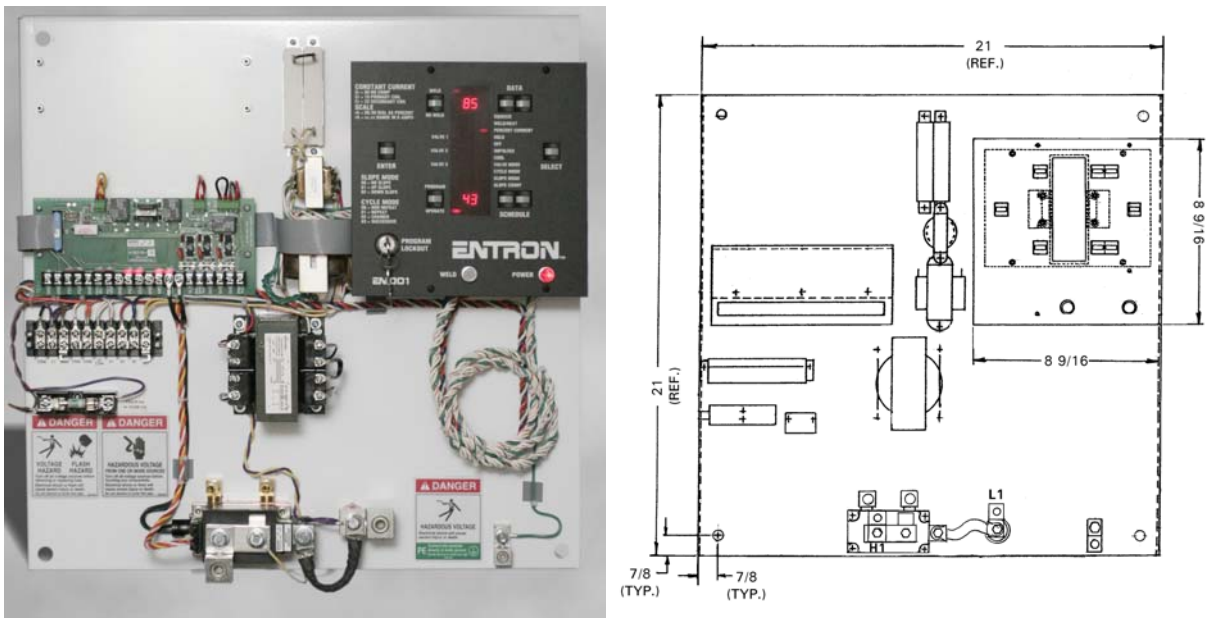
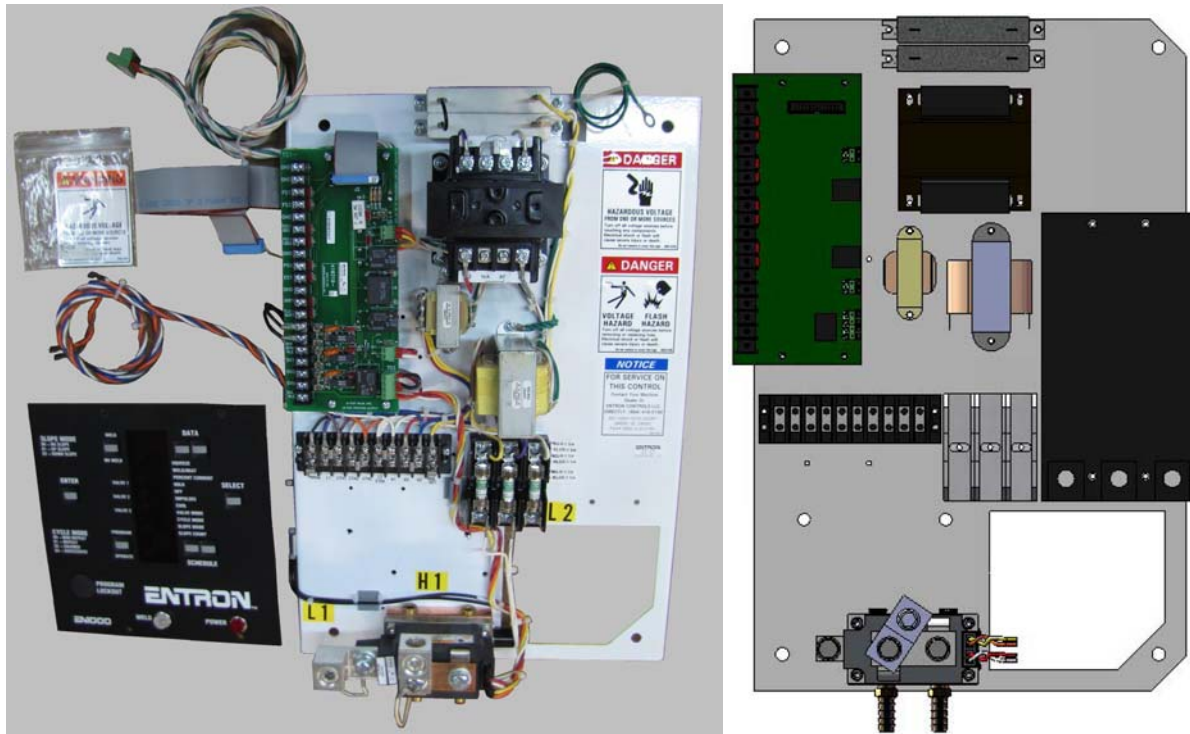
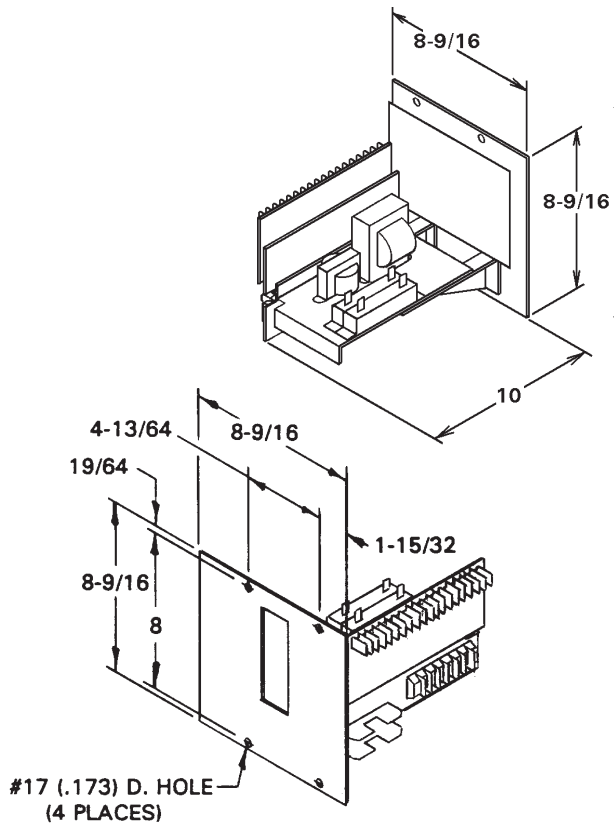
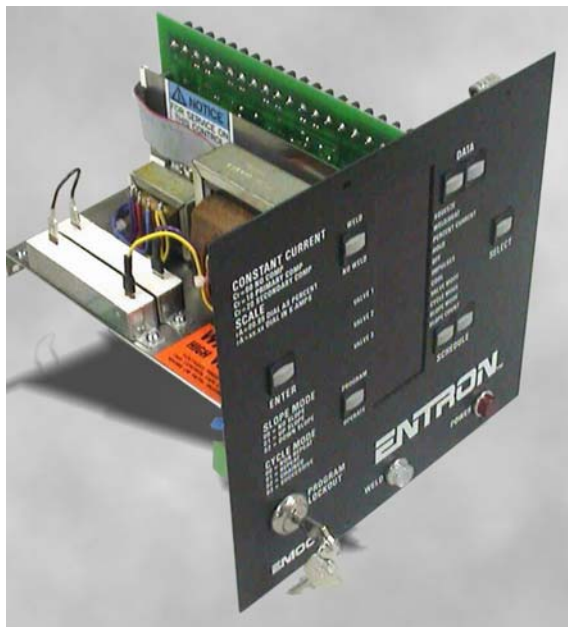


Figure 3-11. Installation and mounting for 21x21 Flat Plate

### 3.5 INSTALLATION AND MOUNTING DIAGRAMS – FLAT PLATE AND IMU (cont.)



**Figure 3-12.** *Installation and mounting for 13x19 Flat Plate*



**Figure 3-13.** *Installation and mounting for Integrated Modular Unit*

See Appendix H for more detailed installation information for IMU.

## 3.6 WELDING TRANSFORMER PRIMARY WIRING

### SCR OR IGNITRON TUBE CONTACTORS

**! DANGER !**

**WHEN POWER IS ON, ALL EXTERIOR SURFACES OF THE IGNITRON TUBES AND SCRS CARRY HAZARDOUS VOLTAGES. CONTACT WITH THESE DEVICES MAY CAUSE SERIOUS OR FATAL INJURIES.**

1. For your convenience, many electrical and mechanical connections have been performed at the factory. Check **ALL** electrical connections to ensure that all connections are tight. Connections may loosen during shipping.
2. Connect the L1 lead from incoming power to the L1 connection located on the contactor assembly. Connect the H1 lead from the welding transformer to the H1 connection located on the contactor assembly. Follow machine manufacturer's recommended wire size for installation. A connection from L2 must be made to TS1-CTH4/L2 to provide power to the control circuitry. Refer to the Wiring Diagram for other connections.
3. When control is supplied with a circuit isolation device, L1 is factory installed and the L2 control wire is connected to TS1-CTH4/L2.

**NOTICE**

Connect a chassis ground to the lug provided on the right wall of the control cabinet and to an external earth ground. **A good earth ground is necessary for proper control operation.**

## 3.7 EXTERNAL SCR CONTACTOR WIRING

External SCR Contactor wiring is shown on Figure 3-14. Connectors J5 and J6 are mounted on PCB2. J12 is located on PCB1.

**Table 3-1.** *External SCR Contactor connections*

Terminal	Connection Description
TS1-L1	Connect to contactor L1 terminal
TS1-H4/XH1	Connect to contactor H1 terminal
TS1-L2/CTH4	Connect to circuit isolation device L2
J5-C	Connect to the cathode of SCR1
J5-G	Connect to the gate of SCR1
J6-C	Connect to the cathode of SCR2
J6-G	Connect to the gate of SCR2
J12-B	Connect to the current coil ( <i>EN1001 only</i> )
J12-W	Connect to the current coil ( <i>EN1001 only</i> )

For more information, refer to appropriate Wiring Diagram (see front page).

**NOTICE**

Do not over tighten J5 or J6.

### 3.7 EXTERNAL SCR CONTACTOR WIRING (cont.)

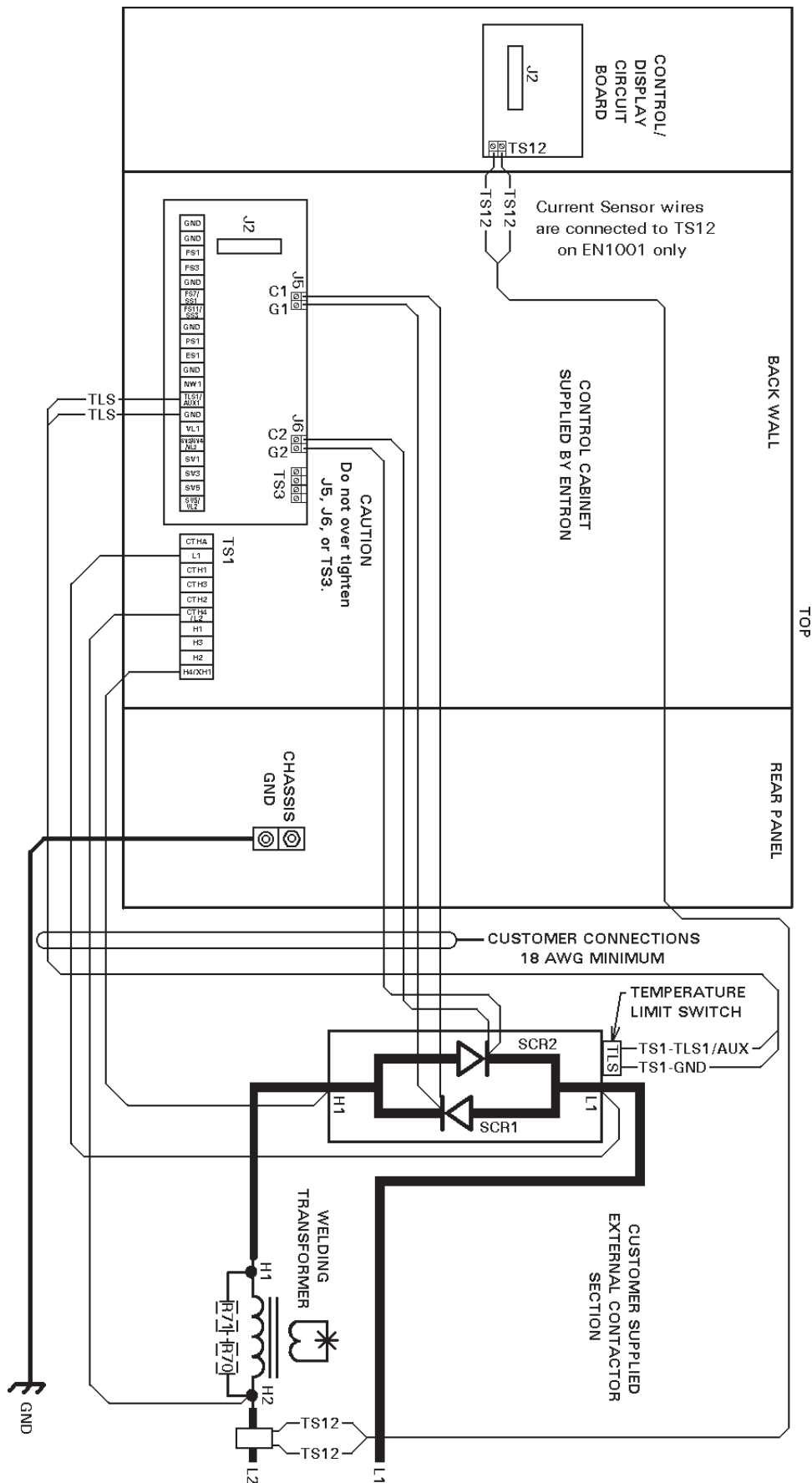


Figure 3-14. External SCR Contactor connections



### 3.8 CONTACTOR SPECIFICATIONS

To help in selecting the proper SCR contactor size for application, use the following “rule of thumb” for sizing SCR contactors for various size transformers.

$$\frac{\text{Transformer KVA} \times 1000}{\text{AC Line Voltage}} \times 3 = \text{Maximum Current Demand}$$

**Example 1:** Using 75 KVA transformer at 230 VAC:

$$\text{Maximum Current Demand} = \frac{75 \times 1000}{230} \times 3 = \mathbf{978} \text{ Amperes}$$

**Example 2:** Using 250 KVA transformer operating at 460 VAC:

$$\text{Maximum Current Demand} = \frac{250 \times 1000}{460} \times 3 = \mathbf{1630} \text{ Amperes}$$

The multiplier factor of 3 in this formula assumes a reasonable secondary configuration of an 8" x 12" throat to a secondary of 13" to 18", with a poor power factor of about 40%, having a necessary adjustment on the welding control of greater than 50 percent current.

A multiplier factor of 2.5 may be used when a machine's power factor is 45% or better. A multiplier factor of 5 or 8 may be required for machines with large secondaries with power factors of 30% or poorer.

When applying the above “rule of thumb”, two other parameters must be considered. **Conduction Time** – the time the welding transformer is energized and the **Duty Cycle** – the ratio of Conduction Time to the complete cycle time (including part handling). These are factors that can substantially alter the selection of a contactor with regard to demand current.

The shorter the Conduction Time and Percent Duty Cycle, the greater the current switching capability of a contactor. Conversely, longer Conduction time and higher Duty Cycle reduce the current switch capability of the contactor.

Figure 3-15 shows suggested relationships for Current Demand, Duty Cycle and Conduction Times. All curves on chart are shown in 30 cycle (60 Hz) conduction time. Assuming maximum 30 cycle conduction time and using Figure 3-15, following recommendations would be made for above examples:

**Example 1:** For 75 KVA transformer operating at 230 VAC, recommended contactor size would be 1200A SCR contactor for Percent Duty Cycle of approximately 14% or less.

**Example 2:** For 250 KVA transformer operating at 460 VAC, recommended contactor size would be 1200A SCR contactor for Percent Duty Cycle of approximately 20% or less.

#### DUTY CYCLE

Duty Cycle is the percent of the time the weld current is on. A convenient formula for calculating Duty Cycle is:

$$\% \text{ Duty Cycle} = \frac{\text{Weld Time (in Cycles)} \times \text{Number of welds per minute}}{36}$$

### 3.8 CONTACTOR SPECIFICATIONS (cont.)

Consult machine manufacturer or local resistance welding supplier for assistance in selecting the proper contactor size that fits application.

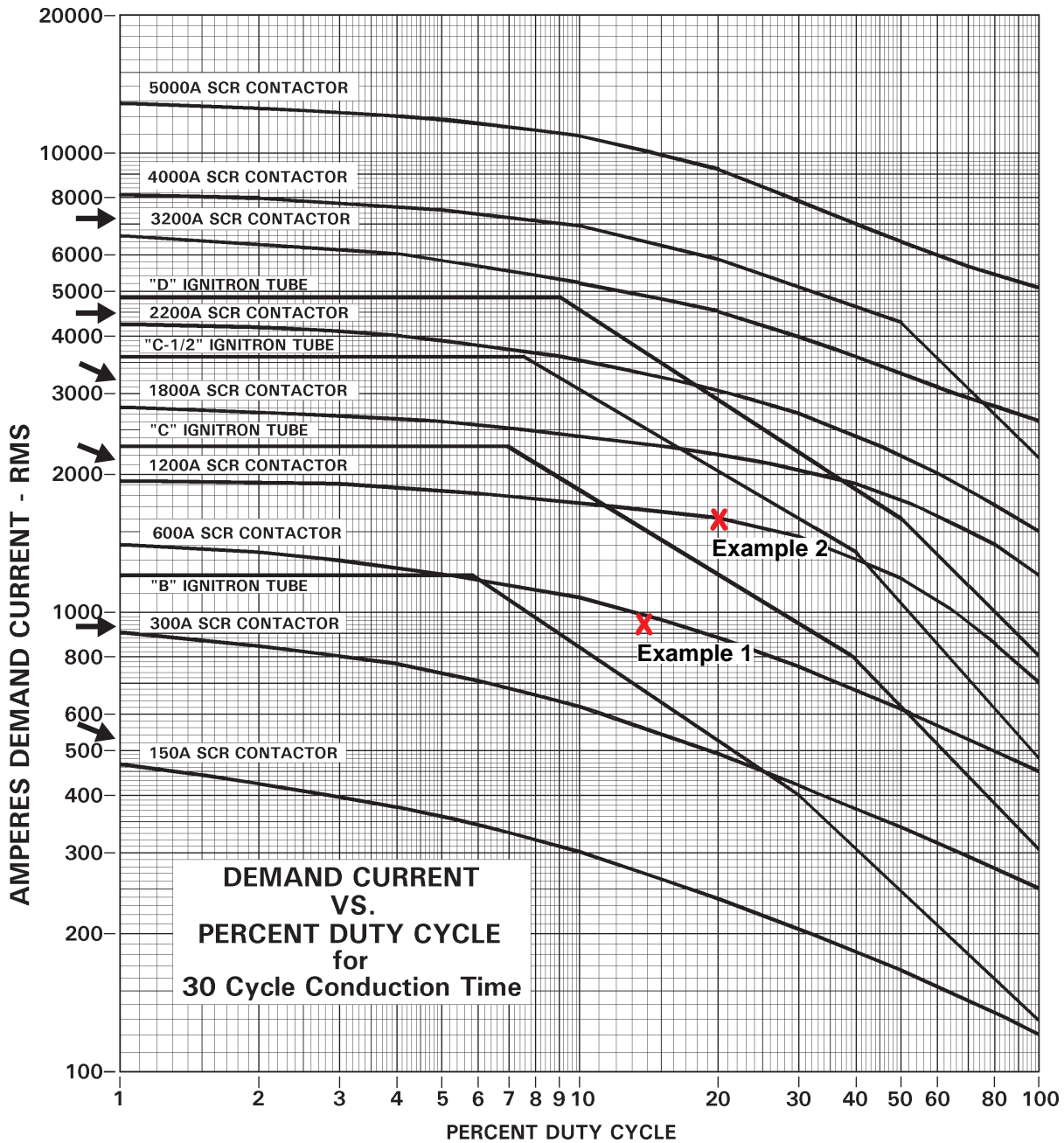


Figure 3-15. Demand Current vs. Percent Duty Cycle

**NOTICE**

**Ignition tubes for reference only.**  
 SCR Contactors available for EN1000/EN1001 are: 150A, 300A, 1200A, 1800A, 2200A, and 3200A (indicated by arrows).

## 3.9 COOLING REQUIREMENTS FOR CONTACTORS

### SOLID STATE MANUFACTURER'S COOLING RECOMMENDATIONS

600 A – SCR Solid State Contactor – *NO LONGER AVAILABLE*

1200 A – SCR Solid State Contactor

1800/2200/3200 A – SCR Solid State Contactor

1 GPM at 104°F (40°C) maximum inlet temperature.

**Be sure power to an electronic contactor is turned off when water is turned off.**

With a voltage applied, most water will ionize and begin to conduct current between points of high differential voltages. This current is sufficient to heat the water past the boiling point, creating steam and possibly causing the rubber hose to burst. The water spraying over the high voltage circuit can cause considerable damage to the contactor and, most likely, the control circuitry as well. Never use metallic or other conductive tubing to plumb a water-cooled resistance welding contactor. Heater hose has a very high carbon content and should not be used for contactor plumbing. A low carbon, reinforced hose (such as the hose originally supplied with the unit), no less than 18" long, must be used to connect the Heatsinks to each other and to the bulkhead fitting on the inside wall of the cabinet (see plumbing instructions on Wiring Diagram).

The 1200A modular water-cooled SCR Contactor is electrically isolated from electrical circuit within the contactor section. No minimum length of water hose is required for electrical isolation of the contactor. It is still recommended to turn power off when control is not in use.

**WATER OFF – POWER OFF  
POWER ON – WATER ON**

For all water-cooled Heatsinks, be sure water is turned ON before placing welder in operation. An open drain is recommended for best operation. If a closed return system is used, be sure return line is properly sized so that back pressure will not reduce water flow below recommendations. A sight flow indicator is recommended.

## 4.0 GENERAL OPERATING REQUIREMENTS

### 4.1 OPERATING VOLTAGE

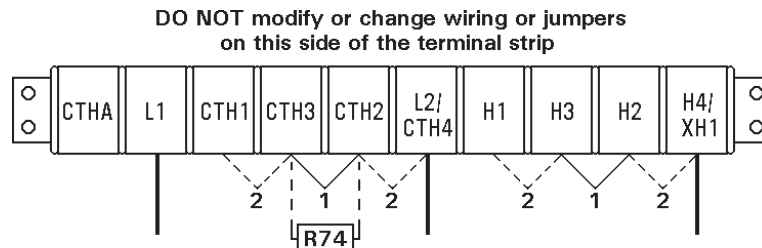
To insure the control will operate properly, it must be properly grounded. Proper grounding is not only a safety precaution, it will lessen the possibility of electrical interference being introduced into the control. Ground the control at the ground lug on the cabinet.

! CAUTION !
<b>THIS WELDING CONTROL OPERATES ON SINGLE PHASE 208 VAC, 240 VAC, 380 VAC, 480 VAC OR 575 VAC.</b>
<b>When the welding control and/or welding machine is shipped, the voltage at which it was set is marked on the tag attached to the control terminal block.</b>

! WARNING !
THIS WELDING CONTROL IS A MULTI-VOLTAGE UNIT WHICH CAN BE CHANGED FROM ONE VOLTAGE TO ANOTHER BY RE-ARRANGING JUMPERS ON THE TERMINAL STRIP FOUND INSIDE THE UNIT. IF THE CONTROL IS USED ON A VOLTAGE OTHER THAN THE ONE FOR WHICH IT IS WIRED, SERIOUS DAMAGE CAN RESULT.

It is possible to operate the EN1000 and EN1001 Series Control at 208, 240, 380, 480, and 575 VAC. When a 380 or 575 VAC main is desired, please consult the factory. When the control is converted from one line voltage to another, there are three changes required:

1. **Control Transformer:** Jumpers on TS1-CTH1, TS1-CTH3, TS1-CTH2, and TS1-CTH4 must be configured to match the line voltage. For TS1 wiring, see Figure 4-1.
2. **Sense Transformer:** Jumpers on TS1-H1, TS1-H3, TS1-H2, and TS1-H4 must be configured to match the line voltage. For TS1 wiring, see Figure 4-1.



**For 480 VAC Operation – Use Jumpers #1**  
**For 240 VAC Operation – Use Jumpers #2**  
**For 380 VAC Operation – CONTACT FACTORY**  
**For 575 VAC Operation – FACTORY WIRED ONLY**

**NO CALIBRATION OR CHANGE REQUIRED FOR  
OPERATION ON EITHER 50 OR 60 Hz.**

**Figure 4-1.** Voltage operation jumpers settings

## 4.1 OPERATING VOLTAGE (cont.)

3. **Valve Transformer:** Jumpers on the valve transformer H1, H3, H2, and H4 must be configured to match the line voltage (see Figure 4-2). The standard Valve Transformer included with the EN1000/EN1001 (either 50 VA or 150 VA) is configured for 240 VAC or 480 VAC input; for 380 or 575 VAC operation, consult the factory.

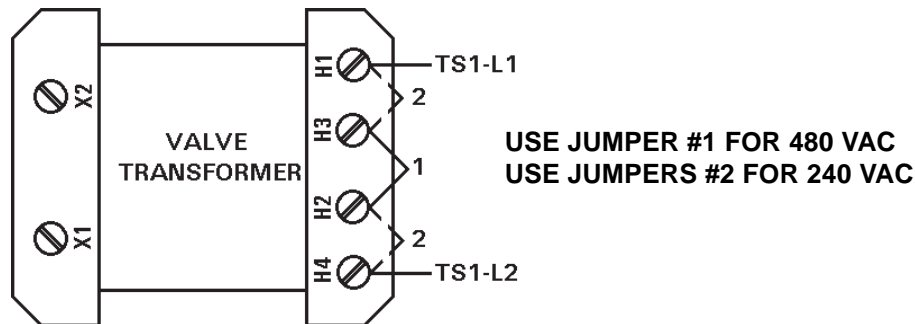


Figure 4-2. Valve Transformer jumper settings

### ! CAUTION !

When external valve power is used (24-240 VAC), Valve Transformer **MUST** be disconnected at TS1-VL1 and TS1-VL2.

Caution must be used to properly insulate the wires from X1 and X2 leads after removing them from TS1.

### NOTICE

Whether valve power is supplied by the Valve Transformer or by an external valve power supply, the maximum current that can be switched by the solid state relays on the Firing Board is maximum 1 A per valve. If more current is desired, the valve circuit should be wired to an external relay having a suitable contact rating to switch the desired valve. For more information, refer to Wiring Diagram shipped with the control.

## JUMPER SETTINGS EXAMPLES:

### 240 Volt Operation Jumpers

Terminal Strip TS1:

- Jumper H1/H3 and H2/H4
- Jumper CTH1/CTH3 and CTH2/CTH4

Valve Transformer:

- Jumper H1/H3 and H2/H4

### 480 Volt Operation Jumpers

Terminal Strip TS1:

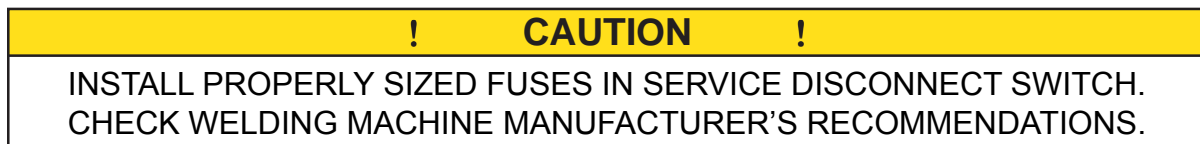
- Jumper H3/H2
- Jumper CTH3/CTH2

Valve Transformer:

- Jumper H3/H2

## 4.2 FUSING AND SAFE OPERATION

CONTROL FUSE	For “S”, “E”, “T/D”, and “L” Cabinets – This fuse, a 1/4 A, is used to protect the control circuits. The fuse holder is located in the upper left corner of the contactor door opening or within the “S” Cabinet. Fusing for “C” Cabinet is different than other cabinets. In “C” cabinets, three 1.25 A fuses are used. L1, H2, and H1 connections are all protected. These fuses protect control circuits, sense circuits, and valve transformer.
VALVE FUSES	These fuses, a 2AG 1 A, are used to protect the valve circuits. These fuses are located on the Terminal Strip PCB.
IGNITOR FUSES	These fuses, BAF 6 A, two per contactor (supplied with ignitron tube retrofit controls only), are used to protect the ignitor circuits of the ignitron tubes. The fuse holders are located on the Ignitron Firing Board Module (A/N 410318).



Observe the **WARNING**, **DANGER** and **CAUTION** labels affixed to the control to maintain safe operation. Some of them are shown in Figure 4-3.



Figure 4-3. Warning, Danger and Caution labels

## 4.3 TERMINAL STRIP DIAGRAMS AND CONNECTIONS

### 4.3.1 TERMINAL STRIP TS1/PCB2

See front page for appropriate Wiring Diagram.

VOLTAGES ON TS1 AND COMPONENTS IN THIS AREA ARE AT LOW LEVEL DC VOLTAGES (5-24 VDC). TS1 INPUTS MAY NOT COME IN CONTACT, OR BE ROUTED WITH OTHER VOLTAGES. INPUTS MUST BE DRY CONTACTS. TO PREVENT GROUND LOOPS, TS1-GND MUST NOT BE CONNECTED TO CHASSIS GROUND.

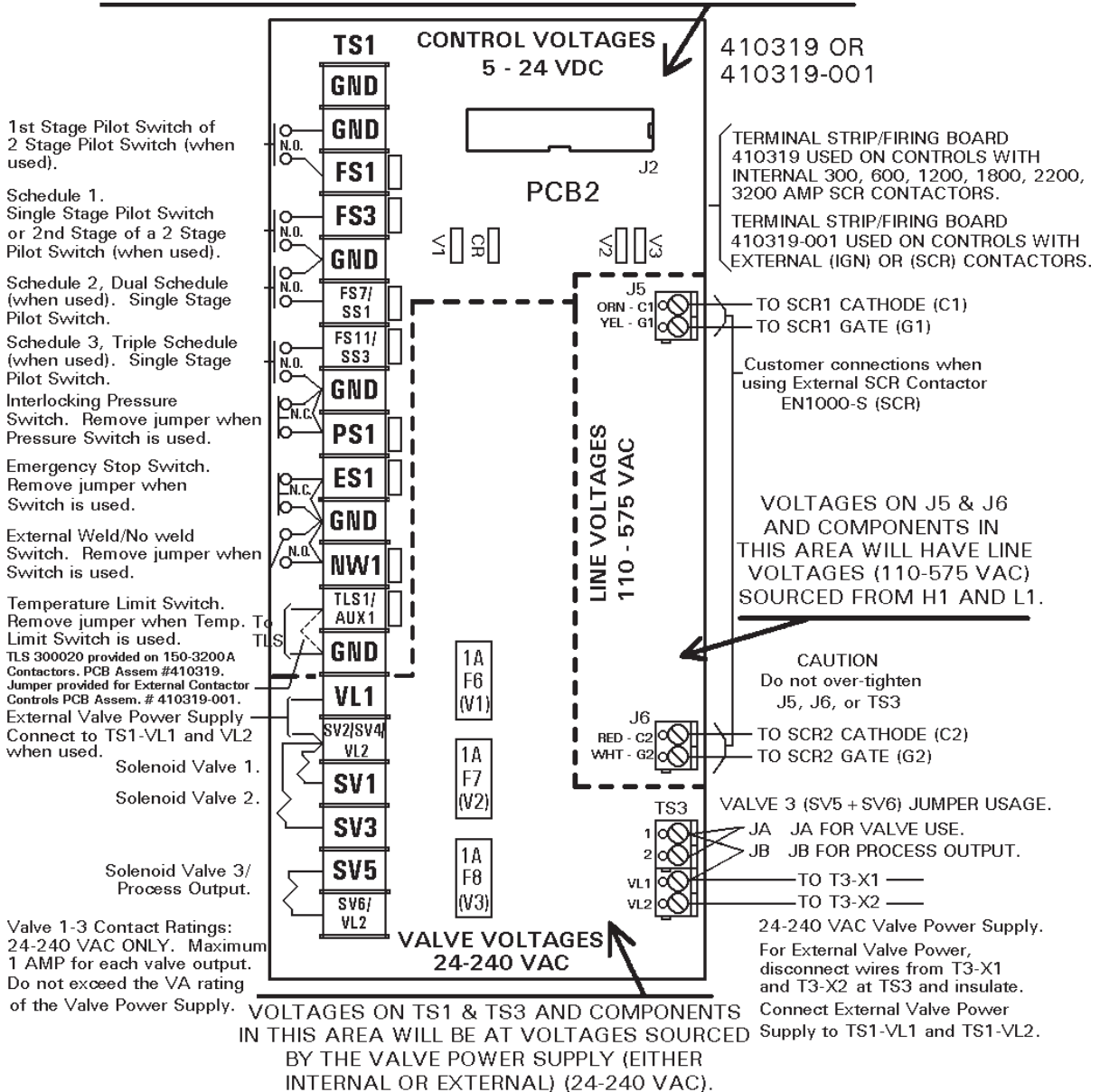


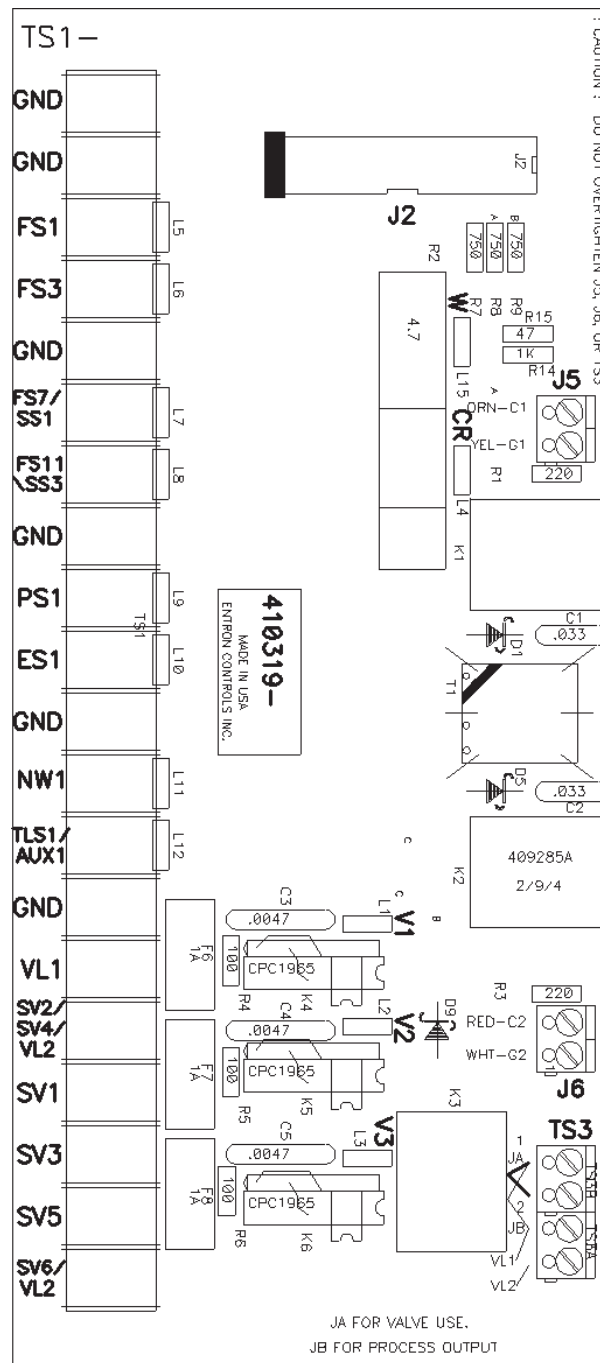
Figure 4-4. Terminal Strip/Firing Board

For most current revision of the component placement on this board, see Figure 4-5.

### 4.3.1 TERMINAL STRIP TS1/PCB2 (cont.)

Starting in June 2004, a new tape-layout revision of Terminal Strip/Firing Board A/N 410319 was shipped with controls. Beside new layout of the components on the board, board now includes optional manufacture of assembly with 24 VDC valves. For more information about 24 VDC valve option, see Application Note 700189.

Valve load resistors have also been omitted. Internal leakage on solid state relays can cause voltages to be seen across unloaded valve outputs. When Valve Terminals are loaded, these voltages will disappear.



**Figure 4-5.** Component placement on new Terminal Strip/Firing Board

For hookup and all terminal connections, see Figure 4-4.



### 4.3.2 TERMINAL STRIP CONNECTIONS – See Figure 4-4 and Figure 4-5

TS1	<i>Terminal Strip Connections Description</i>
-----	---

TS1-GND	Used as the <b>common connection point</b> for all of the other Terminal Strip input connections. There are six GND terminals provided on TS1.
---------	--

TS1-FS1	Used to connect one side of the <b>First Stage of a Two Stage Pilot Switch</b> . Use a single pole, normally open, momentary type switch. Connect the First Stage of a Two Stage Pilot Switch between TS1-FS1 and TS1-GND terminals.
---------	--

<b>! CAUTION !</b>
A JUMPER IS NOT REQUIRED ON TS1-FS1 TO TS1-GND WHEN A TWO STAGE FOOT SWITCH IS NOT USED. <b>DO NOT CONNECT GND TO EARTH GROUND.</b>

TS1-FS3	Used to connect <b>one side of a Single Stage Pilot</b> . Connect a Single Stage Pilot between TS1-FS3 and TS1-GND terminals. Use a single pole, normally open, momentary type switch.
---------	--

–or–

Used to connect **one side of a Two Stage Pilot**. Connect the Second Stage of a Two Stage Pilot between TS1-FS3 and TS1-GND terminals. Use a single pole, normally open, momentary type switch. When initiated via TS1-FS3, the weld control will begin execution at schedule actively shown in SCHEDULE display.

<b>NOTICE – DUAL SCHEDULE</b>
FS3 is used with a Single Stage Pilot for Dual Schedule operation. Connect another Single Stage Pilot between TS1-FS7 and TS1-GND terminals. Use a single pole, normally open, momentary type switch.

TS1-FS7	When initiated via TS1-FS7/SS1, the weld control will begin execution at schedule 10.
---------	---

–or–

Used to connect **one side of a Two Stage Pilot**. Connect the Second Stage of a Two Stage Pilot between TS1-FS7 and TS1-GND terminals. Use a single pole, normally open, momentary type switch.

–or–

Terminal TS1-FS7/SS1 along with TS1-FS11/SS3 can also function as **inputs to select schedules externally** when EXTENDED FUNCTION **5.5.=01**. To connect for EXTERNAL SCHEDULE SELECT, use two single pole, normally open switches, one connected between TS1-FS7/SS1 and TS1-FS3, the other between TS1-FS11/SS3 and TS1-FS3. As shown in Figure 9-16, these switches can now be **used as pointers to one of four schedules**. TS1-FS3 is then used to initiate the schedule pointed to. See Table 5-1 in Section 5.4.3.

–or–

Terminal TS1-FS7/SS1 along with TS1-FS11/SS3 can also function as **inputs for ANTI-TIE DOWN initiations** when EXTENDED FUNCTION **5.5.=02**. To configure TS1-FS7/SS1 and TS1-FS11/SS3 as inputs for ANTI-TIE DOWN, use two single pole, normally open switches, one connected between TS1-FS7/SS1 and TS1-GND, the other between TS1-FS11/SS3 and TS1-GND. See Section 5.4.3.

### 4.3.2 TERMINAL STRIP CONNECTIONS (cont.) – See Figure 4-4 and Figure 4-5

TS1	<i>Terminal Strip Connections Description</i> (cont.)
TS1-FS11	<p>When initiated via TS1-FS11/SS3, the weld control will begin execution at schedule 20.</p> <p style="text-align: center;">–or–</p> <p>Used to connect <b>one side of a third Single Stage Pilot</b>. For initiations of a third of three pre-assigned schedules. Connect a Single Stage Pilot between TS1-FS11 and TS1-GND terminals. Use a single pole, normally open, momentary type switch.</p> <p style="text-align: center;">–or–</p> <p>Used to connect <b>one side of a Two Stage Pilot</b>. Connect the Second Stage of a Two Stage Pilot between TS1-FS11 and TS1-GND terminals. Use a single pole, normally open, momentary type switch. When initiated via TS1-FS11/SS3, the weld control will begin execution at schedule 20.</p> <p style="text-align: center;">–or–</p> <p>Terminal TS1-FS11/SS3 along with TS1-FS7/SS1 can also function as <b>inputs to select schedules externally</b> when EXTENDED FUNCTION <b>5.5.=01</b>. To configure for EXTERNAL SCHEDULE SELECT, use two single pole, normally open switches, one connected between TS1-FS11/SS3 and TS1-GND, the other between TS1-FS7/SS1 and TS1-GND, as shown in Figure 9-16. These switches can now be <b>used as pointers to one of four schedules</b>. TS1-FS3 is then used to initiate the schedule pointed to. See Section 5.4.3 for more information.</p> <p style="text-align: center;">–or–</p> <p>Terminal TS1-FS11/SS3 along with TS1-FS7/SS1 can also function <b>as inputs for ANTI-TIE DOWN initiations</b> when EXTENDED FUNCTION <b>5.5.=02</b>. To configure TS1-FS11/SS3 and TS1-FS7/SS1 as inputs for ANTI-TIE DOWN, use two single, pole normally open switches, one connected between TS1-FS11/SS3 and TS1-GND, the other between TS1-FS7/SS1 and TS1-GND. See Section 5.4.3.</p>
TS1-PS1	Used to connect <b>one side of a Pressure Switch</b> . When used, remove jumper between TS1-PS1 and TS1-GND terminals and install normally open Pressure Switch contacts.
TS1-ES1	Used to connect <b>one side of an Emergency Stop Switch</b> . When used, remove jumper between TS1-ES1 and TS1-GND terminals and install a single pole, normally closed Emergency Stop Switch. It is possible to install several Emergency Stop Switches in series. Activation of any one switch will put the control into the Emergency Stop condition.
TS1-NW1	Used to connect <b>one side of an External Weld/No Weld Switch</b> . When used, remove jumper between TS1-NW1 and TS1-GND terminals and install a single pole, normally open switch. The switch must be in the closed position to weld.
<b>TS1-TLS1/AUX1</b>	Used to connect <b>one side of a Temperature Limit Switch</b> . When used, remove jumper and install a normally closed Temperature Limit Switch between TLS1/AUX1 and TS1-GND terminals. This terminal may also be used for an auxiliary function.

### 4.3.2 TERMINAL STRIP CONNECTIONS (cont.) – See Figure 4-4 and Figure 4-5

TS1	<i>Terminal Strip Connections Description</i> (cont.)
TS1-VL1	Used to connect <b>one side of internal or external Valve Power</b> (115 VAC internal or 24-240 VAC external*).
TS1-SV2/SV4/VL2	Used to connect <b>other side of Valve Power*</b> and <b>other side of Solenoid Valve 1 and 2 coil(s)</b> .
TS1-SV1	Used to connect <b>one side of Solenoid Valve #1 coil</b> .
TS1-SV3	Used to connect <b>one side of Solenoid Valve #2 coil</b> .
TS1-SV5	Used to connect <b>one side of Solenoid Valve #3 coil</b> .
TS1-SV6/VL2	Used to connect <b>other side of Solenoid Valve #3 coil</b> .

**! CAUTION !**

\* When external valve power is used (24-240 VAC), internal Valve Transformer **must** be disconnected at TS1-VL1 and TS1-SV2/SV4/VL2. Properly **insulate** the wires from X1 and X2 of the Valve Transformer.

TS3	<i>Terminal Strip Connections Description</i>
TS3-1	Used as <b>other point for Jumper JA</b> .
TS3-2	Used as <b>common point for Jumper JA or JB</b> .
TS3-VL1	Used as <b>Valve Power Supply Input and other side of Jumper JB</b> .
TS3-VL2	Used as <b>Valve Power Supply Input</b> .

### 4.3.3 TERMINAL STRIP TS1 INSIDE THE CABINET

See front page for appropriate Wiring Diagram.

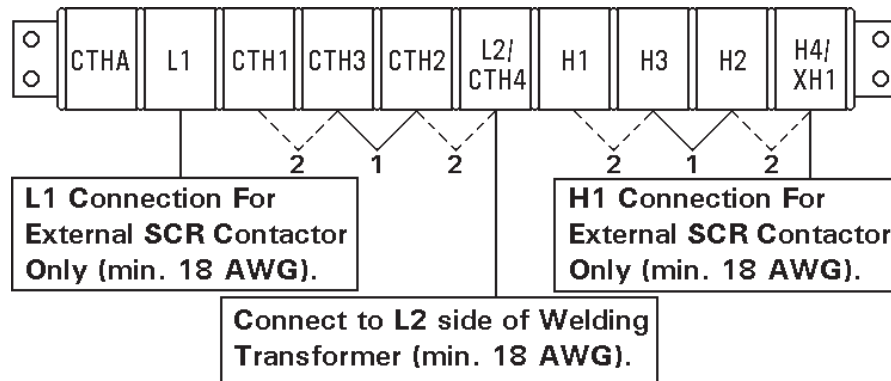
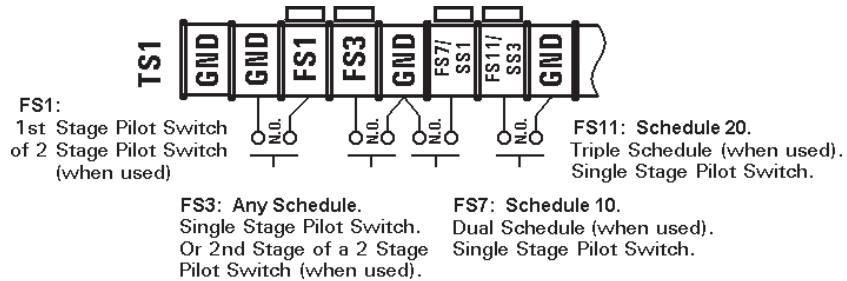


Figure 4-6. Terminal Strip for "T/D" Cabinet

## 4.4 INITIATION

The EN1000 and EN1001 Controls are equipped with four weld initiation inputs – FS1, FS3, FS7 and FS11 – shown in Figure 4-7 (see also Section 5.4.3), and provide two basic weld initiations: Single Stage Pilot and Two Stage Pilot.



**Figure 4-7.** Initiation inputs on Terminal Strip TS1

For more information about routing and wiring of initiation wires, see Section 4.6.

### NOTICE

This control can be programmed to BEAT operation by programming **b.E.** parameter in EXTENDED FUNCTIONS (see Section 5.4.8). Several modes are available.

### 4.4.1 SINGLE STAGE PILOT INITIATION

Connect the Pilot Switch between TS1-FS3 and TS1-GND. Once the control is initiated, the switch need not remain closed. The initiation circuit is automatically latched until the control has completed the sequence. In the REPEAT mode, the control will continue to sequence as long as the initiation remains closed. No connection is made to TS1-FS1. See Section 4.3.

### 4.4.2 TWO STAGE PILOT INITIATION

Connect the First Stage between TS1-FS1 and TS1-GND; then connect the Second Stage between TS1-FS3 and TS1-GND. The First Stage (FS1) activates the solenoid valves programmed in the selected schedule, and will not initiate a sequence. The Second Stage (FS3, FS7 or FS11) initiates the sequence in the schedule associated with the chosen foot switch (FS) connection (see also Section 5.4.3). It is possible to initiate three separate schedules in Two Stage configuration. Once the control is initiated via FS3, FS7 or FS11, FS1 does not need to remain closed. The initiation circuit is automatically latched to prevent re-initiation until after the control has completed its sequence. In the REPEAT mode, the control will continue to sequence as long as either stage remains closed.

## 4.5 OTHER TERMINAL STRIP INPUTS

**WELD/NO WELD SWITCH** and **INDICATOR LEDs** – When the control is in NO WELD, the NO WELD LED is illuminated. This allows the operator to initiate a weld sequence without passing current through the welding transformer. When the WELD LED is illuminated, the control switching circuitry will pass current through to the welding transformer during the programmed WELD time *only* if WELD Switch is closed. If this switch is open, the control will be in the NO WELD mode even if WELD LED is illuminated.

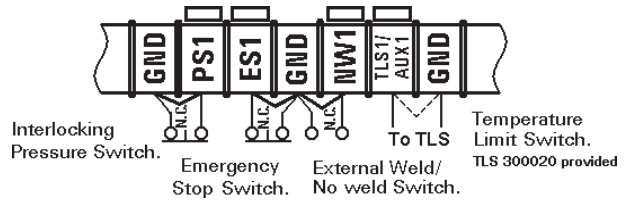
### NOTICE

If a Weld/No Weld Switch is not used, place a jumper (factory installed) between TS1-NW1 and TS1-GND. **Weld/No Weld Switch is not supplied with the control.**

## 4.5 OTHER TERMINAL STRIP INPUTS (cont.)

**PRESSURE SWITCH** – This feature is used to make the control **wait** if the required pressure has not been reached while in the SQUEEZE interval as follows:

After initiation, the control advances through SQUEEZE. If the Pressure Switch is open (pressure not sufficient), the control waits, and the SQUEEZE LED flashes at the end of SQUEEZE. When the Pressure Switch closes (pressure is sufficient), the flashing stops and the control begins to WELD and completes the sequence.



**Figure 4-8.**

*Other inputs on Terminal Strip TS1*

If the Pressure Switch interrupts the sequence for an extended period, the display will flash **ERROR CODE 15**. This error will not terminate the sequence. Once the Pressure Switch closes, the sequence will continue on to WELD and complete the sequence. See Section 4.3.2.

### **NOTICE**

If a Pressure Switch is not used, place a jumper (factory installed) between TS1-PS1 and TS1-GND. **Pressure Switch is not furnished with the control.**

EN1000/EN1001 Series Controls with PROM firmware version 619016-002J or later will have the following Pressure Switch function revised. As of this version, the Pressure Switch will be ignored if WELD time is set to **00**. This allows sequences that use features such as CLAMP & WELD to only have the Pressure Switch checked for the WELD sequence. Before this version, the Pressure Switch was checked after SQUEEZE in all schedules, including CHAINED schedules.

**TEMPERATURE LIMIT SWITCH** – This feature is used to inhibit welding if the temperature of the switching circuitry is above the rated operating temperature (149° F). If the Temperature Limit Switch is open (over temperature), the control cannot be initiated until the Temperature Limit Switch cools (resets/closes). If the Temperature Limit Switch becomes open during a weld, the weld interval will continue until the end of WELD time; HOLD and OFF will execute normally but a new sequence cannot be initiated until the Temperature Limit Switch cools and resets (closes). In either of the above cases, the DATA display will show **ERROR CODE 01** until the Temperature Limit Switch recovers its normally closed state; then the control will return to normal operation.

### **NOTICE**

If the Temperature Limit Switch is not used, place a jumper between TS1-TLS1/AUX1 and TS1-GND.

**EMERGENCY STOP SWITCH** – When the Emergency Stop Switch is open, the control **stops any and all processes (all valves and firing pulses)**. While in the Emergency Stop condition, the control will flash **E.S.** on the DATA and SCHEDULE displays until the condition has been cleared. If the execution of a schedule was interrupted by means of the Emergency Stop Switch, the control will not re-initiate automatically (after the Emergency Stop condition is removed). Upon release of the switch, it must be re-initiated by closing the Pilot Switch.

### **NOTICE**

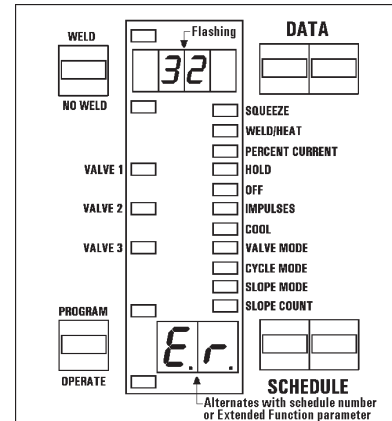
If the Emergency Stop Switch is not used, place a jumper (factory installed) between TS1-ES1 and TS1-GND. **Emergency Stop Switch is not supplied with the control.**

## 4.6 NON-VOLATILE MEMORY ERROR

All ENTRON microprocessor based controls make extensive use of non-volatile memory devices for parameter data storage. Although safety features (control relays and opto-isolation) are in place to insure high voltage spikes do not appear on low voltage circuits, non-volatile memory devices can sometimes be affected by improper hookup, electrical disturbances generated in other equipment operating nearby, or in the welding machine itself.

When an EN1000 or EN1001 Control is powered up or returns from Emergency Stop condition, it executes a diagnostic test that reads all memory locations within schedule storage areas. If invalid data is stored in memory, control will display a flashing **32** in DATA display and **Er.** in SCHEDULE display alternating with schedule number where invalid data (error) is found. If invalid data is found in EXTENDED FUNCTIONS' memory area, **Er.** alternates with EXTENDED FUNCTION parameter designation.

The ERROR **32** indication does not mean there has been damage to welding control. It simply means something has caused invalid data to be stored in one or more memory locations. The control will not sequence until this error has been corrected.



**Figure 4-9.**  
*Flashing 14 or 32 Errors*

To recover from this condition:

1. Press SELECT push button to stop flashing.
2. Place control in PROGRAM mode.
3. The operator can use SELECT to find function containing invalid data.
4. Use DATA push buttons to correct data.
5. Press ENTER.
6. Return control to OPERATE mode.

If more than one location has been affected, it may be necessary to use CLEAR ALL command in EXTENDED FUNCTIONS to erase all memory locations and restore default settings (factory settings).

### Reoccurring ERROR 32 (ERROR 14 Flashing in previous revisions)

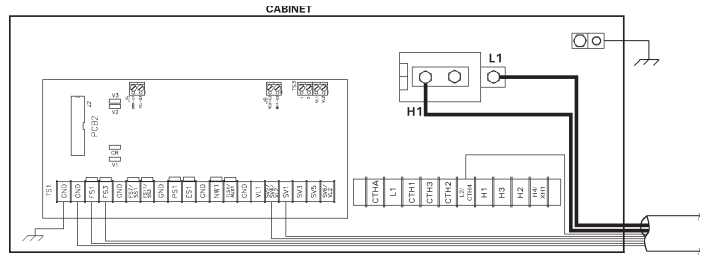
The effects of electrical disturbances can be minimized or prevented by observing the following precautions when installing the welding control:

1. Make sure cabinet is properly grounded to power distribution system, nearby water pipe or other effective building ground with a wire adequate for its application.
2. All wires connected to the pilot input terminals on the TS1 Terminal Strip (FS1, FS3, FS7, FS11, PS1, ES1, NW1, TLS1, and their adjacent GND terminals) should be separated as much as possible from other wires connecting to solenoid valves, welding transformers, and the AC line. These pilot input wires should never be run through the same conduit with solenoid, welding transformer and AC line wires. Connection of any GND terminal to earth ground might cause ERROR 32 or even ERROR 14.

**WRONG** example for wiring and routing of low and high voltage wires in same conduit for typical EN1000/EN1001 Series Controls is shown in Figure 4-10.

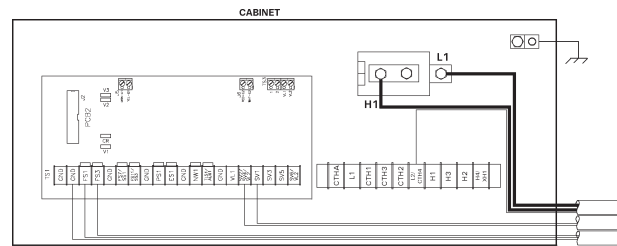
## 4.6 NON-VOLATILE MEMORY ERROR (cont.)

L1 and H1 will radiate electromagnetic spikes onto the parallel wires bundled with it. Initiation wires are low voltage and are most vulnerable to electromagnetic spikes. Also, a short within this bundle could cause severe damage. **CAUTION: NEVER** connect Terminal Strip GND to earth ground.



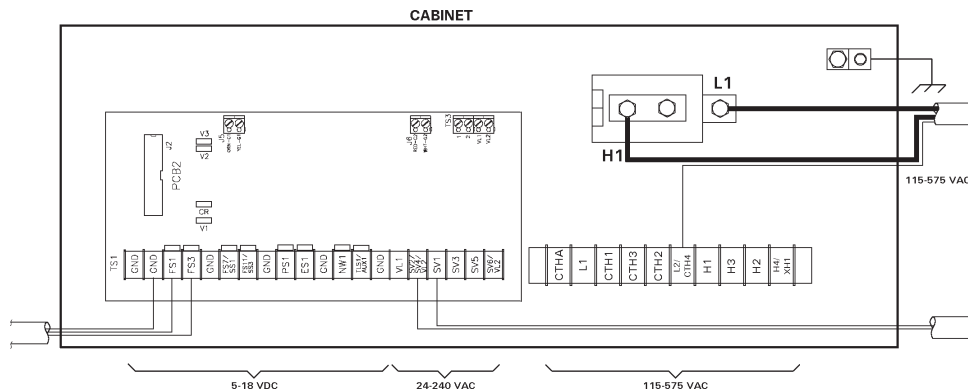
**Figure 4-10. Wrong routing of low and high voltage wires**

**BETTER** example is shown in Figure 4-11. Wires are routed parallel to each other but in separate grounded conduits. Conduits isolate vulnerable wires and reduce noise, but often, when conduits are running parallel, wires will have some unprotected travel distance inside cabinet. This could couple some electromagnetic spikes onto more vulnerable low voltage circuits.



**Figure 4-11. Better routing of low and high voltage wires**

Use **BEST** wiring method shown in Figure 4-12 to minimize introduction of induced electrical transient spikes that cause corrupt data to be stored in control's microprocessor. Note that all low voltage initiation wires have been physically isolated from any high voltage wiring. The routing method used in our example is not possible in all applications, but should be considered the best possible. It would be ideal to route and exit low voltage terminals (5-18 VDC) at least 6" or more or at opposite end of cabinet from higher voltage terminals (24-240 VAC) and (115-575 VAC).



**Figure 4-12. Recommended routing of low and high voltage wires**

### NOTICE

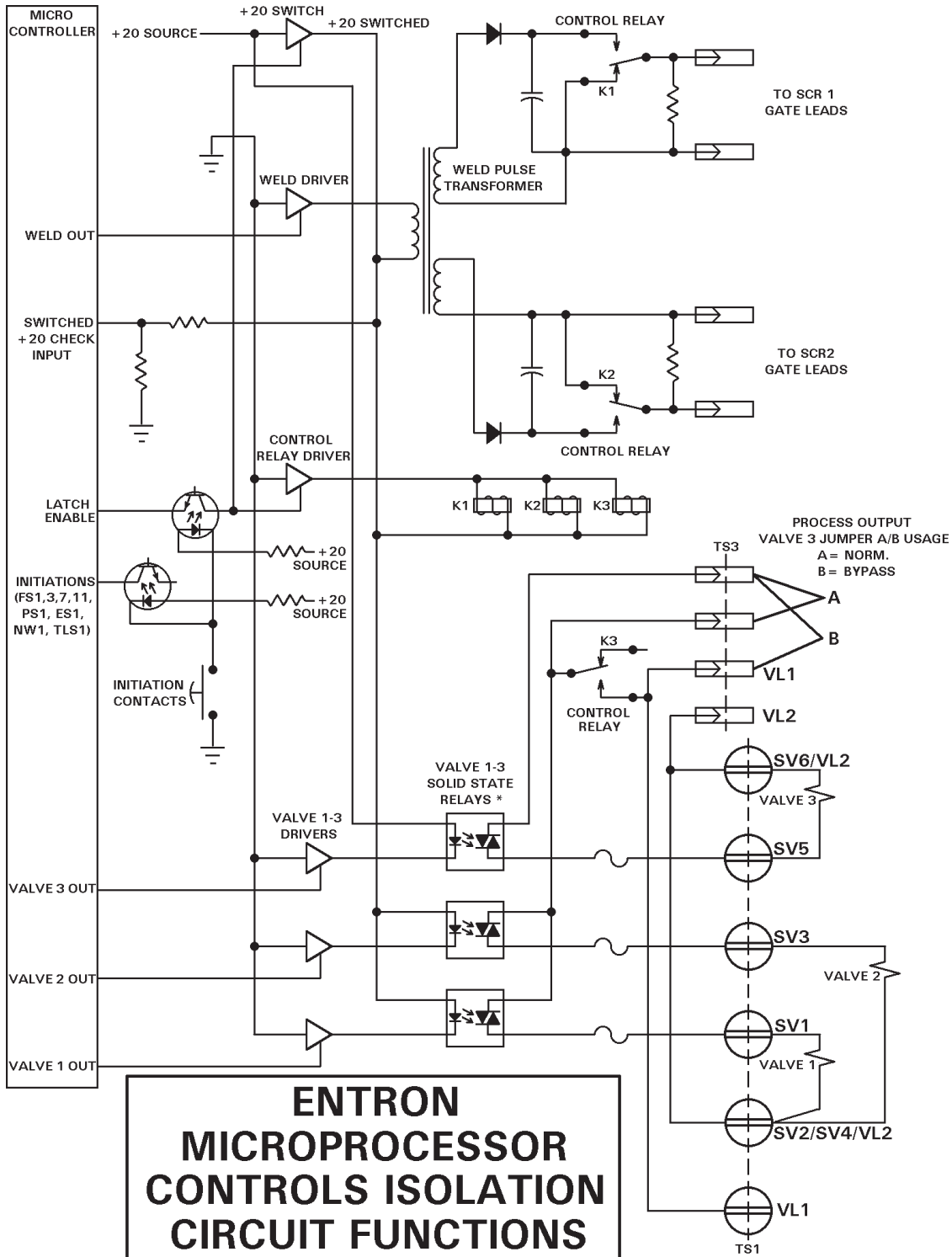
The GND designations on Terminal Strip TS1 are commons only (nominally at ground potential). These points should never be grounded externally. However, control cabinet must be properly grounded using ground lug on inside of cabinet.

### NOTICE

**Avoid routing high and low voltage wires parallel to each other to eliminate coupling adjacent signals which may cause irregular operation.**

## 4.7 ISOLATION CIRCUITRY DESCRIPTION

The EN1000 Series Controls are microprocessor-based resistance welding controls that incorporate circuitry designed to prevent any output from the control due to spurious or unexpected or false conditions or failure of circuit components. The intent of this section is to explain how the circuitry accomplishes this isolation.



\* NOTE: SOLID STATE RELAYS MAY BE AC OR DC TYPE RELAYS.

Figure 4-13. Isolation circuit block diagram



## 4.7 ISOLATION CIRCUITRY DESCRIPTION (cont.)

The main isolation is provided by electro-mechanical control relay contacts that are in series with the solenoid valve voltage supply and the contactor firing circuitry. In a non-initiated state, the relay contacts are open and no output from these circuits are possible. When the control is initiated by the physical closure of a normally open set of external contacts (commonly a foot switch) across the initiation circuit, the relays are energized and their contacts close and complete the circuits to the solenoid valve and the contactor. The outputs are not actually energized, however, until the microprocessor reaches the point in the sequence at which the valve or contactor outputs are to be activated.

There is no way to guarantee that any control circuit will be immune to component failure. It is always necessary to take personal safety precautions when operating any machinery. Through a PROCESS OUTPUT system, the EN1000 Series Controls can be programmed so that if the 20 volt energizing voltage for the isolation relays appears in the absence of an initiation, or if the SCR contactor conducts current at any time other than when programmed, an output voltage will appear at the Valve 3 terminals. This voltage can be used to sound an alarm or operate a shunt trip breaker to remove line voltage from the machine and the control.

In addition to the relay contacts mentioned above, there are other levels of isolation. The initiation signals first pass through a circuit comprised of opto-isolators before being passed to the input circuitry of the microprocessor. The valve outputs are further isolated by the use of optically coupled triac (solid state) outputs and the weld pulses are isolated by a pulse transformer.

### **NOTICE**

Valve 3 (SV5/SV6) will not be isolated if Jumper B is used on TS3 (see Figure 4-13).

## 5.0 INTRODUCTION TO DATA PROGRAMMING

The EN1000 or EN1001 Control is capable of storing and accessing up to 50 unique welding schedules. This makes the EN1000 or EN1001 particularly suitable for complex welding operations, as well as automated machinery. Programming allows the operator to enter or change parameters of weld schedules and the subsequent storing of those parameters in non-volatile memory.

Basically, programming only requires **selecting** the function to be programmed (or modified), **changing** the data (with DATA display and push buttons) applicable to that function, and then **entering** the desired parameters into memory. For more detailed information about programming, see Appendix B, Section B-1.0.

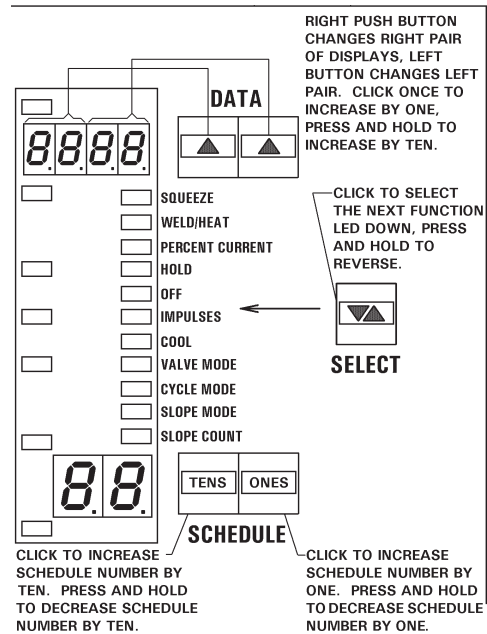


Figure 5-1. Four-digit DATA display

### 5.1 GENERAL PROGRAMMING

1. **Press and release the PROGRAM/OPERATE push button.** The PROGRAM LED will light up and the OPERATE LED will turn off. Only in the PROGRAM mode does the control allow changes to existing data or entering new data. If an optional PROGRAM LOCKOUT key switch is installed, see Section 5.2.
2. **Select the schedule to be entered or modified by using the SCHEDULE push buttons** until the desired schedule number appears in the SCHEDULE display. The left push button increments the display by ten, and the right push button increments the display by one. When the maximum number is reached for either digit, that digit resets to zero.
3. **Press the SELECT push button to reach the required function.** Pressing and holding the SELECT push button momentarily will move to the previous parameter. The FUNCTION indicator LEDs show which function may be entered or modified, and the DATA display shows the data stored in that function. If the SELECT push button is pressed again, the FUNCTION indicator LED will advance to the next function.

#### NOTICE

When the FUNCTION indicator LED is advanced one position past the SLOPE COUNT function, all FUNCTION indicator LEDs will be off and the DATA display will show **EF**. This indicates that the control is in the EXTENDED FUNCTION mode and the EXTENDED FUNCTIONS can now be altered or viewed (see Section 5.4).

4. **Use the DATA push buttons to change data.** The left button increments the data by ten, and the right button increments the data by one. When either digit reaches the maximum, that digit resets to zero. For parameters which allow programming of all four digits, the right button affects the two right-hand digits – click to increment by one; press and hold to increment by ten. The left button affects the two left-hand digits – click to increment by 100; press and hold to increment by 1000.
5. **Press the ENTER push button to store data from the DATA display into non-volatile memory.** As ENTER is pressed, the DATA display will blink and then remain steady.

## 5.1 GENERAL PROGRAMMING (cont.)

Repeat the steps described above as required. Any or all functions may be programmed depending on the final welding schedule or sequence required.

### NOTICE

**Remember to press the ENTER push button to complete a programming step.** If the control is placed back in the OPERATE mode, or if a different function is selected before pressing ENTER, **the DATA shown in the display will be lost.** The previous data will remain stored in memory.

6. When all the required functions for all required schedules have been programmed, put the control in the OPERATE mode by pressing and releasing the PROGRAM/OPERATE push button, so that the OPERATE LED turns on and the PROGRAM LED turns off.

## 5.2 PROGRAM LOCKOUT OPTIONS

### 5.2.1 PROGRAM LOCKOUT KEY SWITCH OPTION

A PROGRAM LOCKOUT key switch can be ordered as a factory-installed option. It may also be added later by the customer, if desired. To install, remove the key switch hole plug from the lower left corner of the Front Panel and mount the switch using the nut and lock washer provided. Connect the plug from the switch onto the mating 2-prong connector (J1) on back of the Display Circuit Board.

Mounting the key switch will be easier if the Front Panel Circuit Board Assembly is removed from the enclosure. Remove the four mounting screws from the Front Panel and lift it off of the enclosure.

#### **To put the control in the PROGRAM mode using the PROGRAM LOCKOUT key switch:**

Rotate the key 45 degrees clockwise and hold; while holding the key in this position, press and release the PROGRAM/OPERATE push button, and then release the key. The OPERATE LED will now turn off and the PROGRAM LED will turn on, indicating programmability of all functions.

#### **To put the control in the OPERATE mode:**

Press the PROGRAM/OPERATE push button again. The control will return to the OPERATE mode without the necessity of rotating the key.

### 5.2.2 USING PROGRAM LOCKOUT KEY SWITCH FOR ERROR CLEARING

Most errors except initiation, heatsink over temperature, and pressure errors (ERROR CODES from **01** to **15** and **36**), may be cleared by pressing any push button on the Front Panel. However, if a PROGRAM LOCKOUT key switch is installed in the control, a key is required to clear the ERROR condition and reset the control for voltage monitoring, current monitoring and several other non-hardware related ERROR CODES (all codes from **17** to **35**, **37**, **H. 1.** and **L.o.**).

### 5.3 SEQUENCE (SCHEDULE) PARAMETERS PROGRAMMING

Beside standard SCHEDULE parameters, there are several EXTENDED parameters. The associated EXTENDED SCHEDULE parameters are accessible by first using SELECT to choose the main function such as SQUEEZE, and then clicking either SCHEDULE push button to access a schedule function such as *P.r.* or *P.t.*

PARAMETER	EXTENDED	Description	MIN	MAX
SQUEEZE		SQUEEZE time in 50/60Hz cycles	00	99
*	<i>P.r.</i> , <i>P.t.</i> (PSI)	PRESSURE mode: <i>P.C.</i> = <b>01</b> or <b>02</b>	00	99
	<i>F.r.</i> , <i>F.t.</i> (lb)	FORCE mode: <i>P.C.</i> = <b>03</b> or <b>04</b>	0000	9999
	<i>R.r.</i> , <i>R.t.</i> (mA)	CURRENT mode: <i>P.C.</i> = <b>05</b> or <b>06</b>	04.00	20.00
WELD/HEAT			00	99
#	<i>a.0</i> to <i>a.9</i>	Stepper 1, schedule <b>00</b> to <b>09</b>		
	<i>b.0</i> to <i>b.9</i>	Stepper 2, schedule <b>10</b> to <b>19</b>		
	<i>c.0</i> to <i>c.9</i>	Stepper 3, schedule <b>20</b> to <b>29</b>	0000	9999
	<i>d.0</i> to <i>d.9</i>	Stepper 4, schedule <b>30</b> to <b>39</b>		
	<i>e.0</i> to <i>e.9</i>	Stepper 5, schedule <b>40</b> to <b>49</b>		
	<i>L.S.</i>	LAST STEP for STEPPER <i>S.t.</i> = <b>01</b>	00	49
	<i>L.C.</i>	LAST COUNT for STEPPER <i>S.t.</i> = <b>01</b>	0000	9999
PERCENT CURRENT		PHASE SHIFT in [%] mode	00	99
**	[%] mode <b>EN1001 only</b>	CURRENT in [%] or [kA]: <i>C.r.</i> > <b>00</b>	00.00	99.99
	or <i>L.o.</i> +	LOW CURRENT limit window	00.00	99.99
	[kA] mode <i>H. i.</i> +	HIGH CURRENT limit window	00.00	99.99
HOLD			00	99
OFF			00	99
IMPULSES			01	99
COOL			00	99
VALVE MODE			00	07
CYCLE MODE			00	05
SLOPE MODE			00	02
SLOPE COUNT			00	99

\* Available only if IPSC option is present. For more information, see Instruction Manual 700178.

# For more information about programming and using STEPPER function, see Section 7.0.

\*\* Available only in EN1001 Controls. For more information about Constant Current, see Section 8.0.

+ See Section 8.3.2 for programming information.

Times for WELD, COOL, SLOPE COUNT and all other timed sequence parameters (SQUEEZE, HOLD, OFF) are based on 60 Hz or 50 Hz frequency.

## 5.3.1 USING PROGRAMMING SHORTCUTS

### TO QUICK COPY A SCHEDULE UP TO THE NEXT SCHEDULE

1. Put the control in the PROGRAM mode.
2. Press and hold ENTER.
3. Click the SCHEDULE 1s button.

The displayed schedule is copied to the next higher schedule. The new schedule is now displayed.

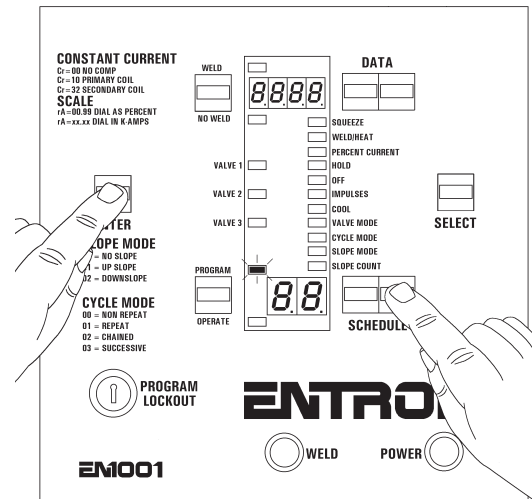


Figure 5-2. Copy schedule up by 1

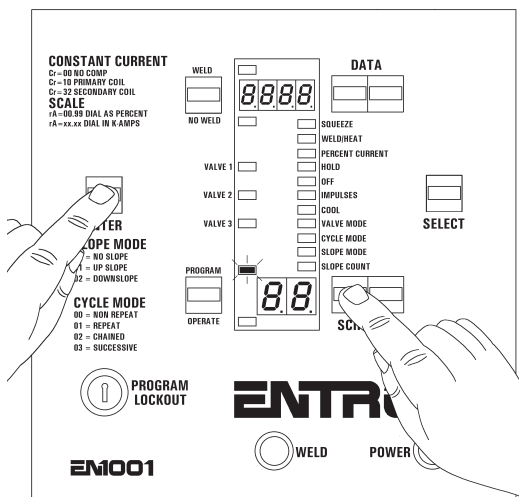


Figure 5-3. Copy schedule up by 10

### TO QUICK COPY A SCHEDULE UP TEN SCHEDULES

1. Put the control in the PROGRAM mode.
2. Press and hold ENTER.
3. Click the SCHEDULE 10s button.

The displayed schedule is copied to that schedule number plus ten. The new schedule is now displayed.

### TO CLEAR DATA FOR DISPLAYED SCHEDULE

1. Put the control in the PROGRAM mode.
2. Press and hold ENTER.
3. Click the PROGRAM/OPERATE button.

All SCHEDULE data for the displayed schedule has been erased.

### TO CLEAR ALL EXTENDED FUNCTIONS FROM CONTROL

1. Remove all power to the control.
2. Press and hold the PROGRAM/OPERATE push button.
3. Reapply power to the control.

All EXTENDED FUNCTIONS parameters in the control have been erased.

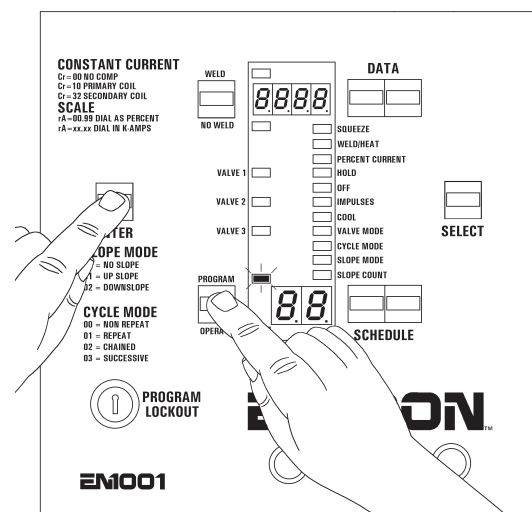


Figure 5-4. Clear SCHEDULE data

## 5.4 EXTENDED FUNCTIONS

The EN1000/EN1001 EXTENDED FUNCTIONS allow the operator to change normal operation modes and add various operating functions that are useful for special applications of the control.

The EXTENDED FUNCTIONS are used instead of Jumper or Dip-switch settings. They are accessible from the Front Panel by simply clicking the SELECT push button until FUNCTION indicator LED reaches SLOPE COUNT, then click once more. At this point, the DATA display will show **EF**. By clicking the SCHEDULE push buttons, the EXTENDED FUNCTIONS are visible in the SCHEDULE display. For most features, such as CHAINED schedules or SUCCESSIVE initiations, it is not necessary to enable functions. For some others such as STEPPER (**S.t.**), it is necessary to just enable a Front Panel-accessible EXTENDED FUNCTION. For others, it is necessary to add optional hardware to the base control, such as the Integrated Pressure Sense Control System or Constant Current operation.

To change settings of EXTENDED FUNCTIONS, use SELECT to step once past SLOPE COUNT.

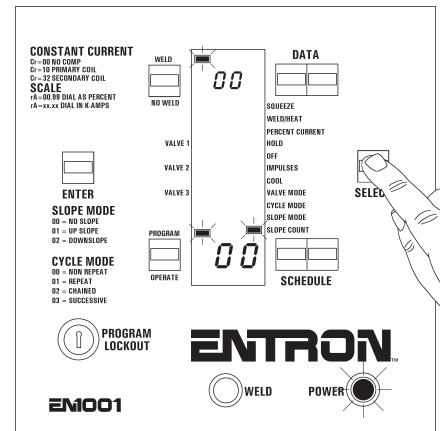


Figure 5-5. Selecting functions

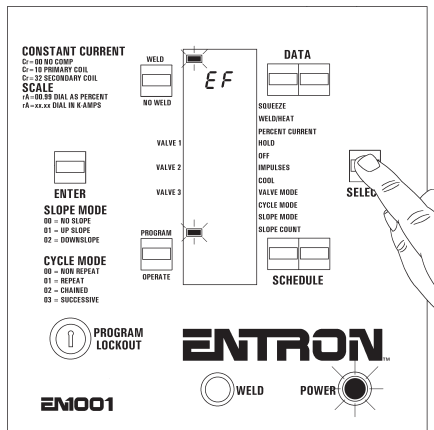


Figure 5-6. EXTENDED FUNCTIONS mode

At this point, all FUNCTION indicator LEDs are off and the DATA display shows **EF**. This indicates that the control is in the EXTENDED FUNCTION mode, and these functions can be altered or viewed.

To view EXTENDED FUNCTIONS, press the SCHEDULE push buttons and step in either direction through the available EXTENDED FUNCTIONS. When a desired parameter is shown by the SCHEDULE display, the DATA display will show the current value of that selection.

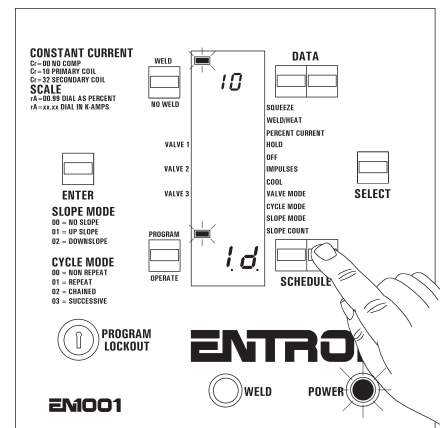


Figure 5-7. Viewing EXTENDED FUNCTIONS

To exit the EXTENDED FUNCTION mode, press SELECT to advance the FUNCTION indicator LED one more time.

## 5.4 EXTENDED FUNCTIONS (cont.)

The available EXTENDED FUNCTION parameters are listed below – they are described in the indicated sections.

Designation	Description	Section
<i>I.d.</i>	Identification Number	5.4.1
<i>S.E.</i>	Seam Welding Mode	5.4.2
<i>S.S.</i>	Schedule Select	5.4.3
<i>C.C.</i>	Automatic Voltage Compensation & Monitoring	5.4.4
<i>C.R.</i>	Clear All Functions	5.4.5
<i>b.S.</i>	Back-Step / Temperature Limit Switch	5.4.6
<i>P.O.</i>	Process Outputs	5.4.7
<i>b.E.</i>	Beat Operation Initiation Modes	5.4.8
<i>B.7.</i>	87° Delay	5.4.9
<i>P.P.</i>	Manual Power Factor Programming	5.4.10
<i>P.F.</i>	Power Factor Measuring	5.4.11
<i>S.d.</i>	Squeeze Delay	5.4.12
<i>b.L.</i>	Blocking Delay (if <i>P.O.</i> = <b>07</b> only)	5.4.13
<i>t.r.</i>	Turns Ratio	5.4.14
<i>C.r.</i>	Constant Current Modes	<i>Available only for EN1001 using Constant Current</i> 5.4.15
<i>r.R.</i>	Range	5.4.16
<i>C.O.</i>	Current Offset	5.4.17
<i>S.t.</i>	Stepper	7.0
<i>P.C.</i>	Pressure Control Mode	<i>Available only if IPSC hardware is present</i> See Instruction Manual 700178 for IPSC
<i>b.d.</i>	Background Pressure	
<i>S.I.</i>	Sensor Input	
<i>P.n.</i>	PIN Lockout Mode	5.4.18

### 5.4.1 IDENTIFICATION NUMBER – *I.d.*

The EN1000/EN1001 Control may be equipped with RS485 Option to communicate to a PC or any other device with RS485 interface. The device with RS485 interface is capable of communicating with up to 64 controls on a common two-wire network. For this reason the control needs to be identified. See Instruction Manual 700171 for more information.

### 5.4.2 SEAM WELDING MODE – *S.E.*

To program the control for SEAM operation:

1. Put the control in PROGRAM mode.
2. Use SELECT to find **EF**.
3. Use the SCHEDULE push buttons to scroll through EXTENDED FUNCTIONS and find **S.E.**

## 5.4.2 SEAM WELDING MODE – 5.É. (cont.)

4. Enter a value for **5.É.** of **0/** using the DATA push buttons.
5. Press the ENTER push button.

Entering **5.É.=00** into the DATA display puts the control back in SPOT mode.

A seam welder can be operated in one of two modes: INTERMITTENT and CONTINUOUS. In either SEAM mode, current starts synchronously upon initiation, remains on as long the Pilot switch is closed, and stops synchronously when the Pilot switch is opened.

### INTERMITTENT SEAM MODE

INTERMITTENT SEAM welding is the mode of operation in which weld current flows only for the duration of the WELD/HEAT time setting and is off during the COOL. The INTERMITTENT operation continues as long as the initiation switch remains closed. When the initiation is opened, the sequence ends. WELD/HEAT time is the time duration in which weld current flows in a single impulse, and must be programmed for at least 1 cycle. COOL time is the time between subsequent WELD/HEAT impulses.

If the initiation is opened during a WELD/HEAT time, the impulses end immediately and advances to HOLD time. If the initiation is opened during a COOL time, the sequence ends at the end of the programmed COOL time and advances to HOLD time.

### CONTINUOUS SEAM MODE

CONTINUOUS SEAM welding is the mode in which current flows continuously as long as the pilot switch remains closed. COOL time is programmed to **00**, and WELD must be programmed for at least 1 cycle, for CONTINUOUS SEAM mode.

Notice that in either SEAM mode, initiations can be changed during the welding of a seam to provide different heat-cool pattern and/or a different percent current. This feature is useful to compensate for possible machine power factor changes which may occur as a seam is being welded. As an example, a seam may be started by closing FS3 to GND, then closing FS7 to GND and finally closing FS11 to GND as the seam progresses. The highest number closed to GND determines which schedule will be active. Schedule changes made during a HEAT or COOL time become effective immediately. When in SEAM mode, the FS3 initiation will use the dialed schedule, FS7 will use schedule 10, and FS11 will use schedule 20.

#### **NOTICE**

Some SEAM features may be desired when the control is used for resistance brazing or soldering applications. See Section 5.4.8 on BEAT operation.

#### **! WARNING !**

**Care MUST be taken to minimize the overheating of internal components when in the SEAM mode. Correct transformer power dissipation (sizing) and welding control capability are essential to avoid component overheating.**



## 5.4.2 SEAM WELDING MODE – 5.É. (cont.)

### **! WARNING !**

**In SEAM welding, the duty cycle is typically higher since the weld current is flowing for more time. Use caution not to overheat the transformer or control circuitry when in SEAM mode. See Application Note 700199 regarding External Surge Resistors.**

The EN1000 or EN1001 Control is equipped with a Temperature Limit Switch, usually mounted on the Heatsink of the SCR Contactor. An ERROR CODE of **0I** will appear on the display if the Temperature Limit Switch is open.

## OTHER SEAM MODES

### **SEAM Mode 5.É.=02 – Adjust CURRENT During Weld**

In this mode, during welding it is possible to change PERCENT CURRENT (Up-Down current adjustment) with DATA push buttons. Use DATA 10s push button to increase PERCENT CURRENT, and DATA 1s push button to decrease.

### **SEAM Mode 5.É.=03 – SEAM/SPOT Sequence Combination**

This mode is SEAM/SPOT sequence combination. Initiation FS7 and schedule 10 will always be SPOT sequence in this mode. SEAM sequence can be initiate with FS3 either in CONTINUOUS or INTERMITTENT mode, and, whenever FS7 is closed, control will jump from SEAM to SPOT sequence on schedule 10.

Also in this mode, since PROM firmware version 619016-002P, it is possible to add a CHAINED SPOT sequence with no welding schedules before CONTINUOUS or INTERMITTENT SEAM part of the sequence with FS3 initiation.

### **SEAM Mode 5.É.=x4 – DELAY Compensation**

In CONSTANT CURRENT mode on EN1001 Controls, this mode is used to add DELAY before control starts to compensate or regulate current. The variable *x* indicates the number of initial cycles during which compensation is delayed. For example, if **5.É.=54**, then during first five weld cycles, control will only perform current measurement without any compensation, and on sixth cycle it will start to compensate.

## 5.4.2 SEAM WELDING MODE – 5.É. (cont.)

### SEAM Mode 5.É.=06 – NON-BEAT SEAM

This mode was primarily designed as NON-BEAT SEAM mode, enabling execution of a fixed time weld using a number of repetitions in addition to alternating two heats within single schedule.

The control is programmed as follows:

1. Use the SELECT push button until the DATA display shows **ÉF**.
2. Use the SCHEDULE push buttons to find **5.É.** in the SCHEDULE display.
3. Program a value **5.É.=06** and press the ENTER push button.
4. Use the following information to program working schedule.

#### NOTICE

By definition, the SEAM mode is a BEAT mode operation. In a normal SEAM mode, CHAINED mode of welding schedules is not available.

SQUEEZE count		[normal SQUEEZE]
WELD/HEAT count	[WELD 1]	[normal WELD time]
PERCENT CURRENT	[PERCENT 1]	[normal PERCENT]
HOLD count		[normal HOLD time]
OFF count	[PERCENT 2]	[new second PERCENT heat]
IMPULSES	[Weld(1+2)*Factor]	[repetition factor for overall WELD time]
COOL count	[WELD 2]	[new COOL will execute a second WELD/HEAT]
VALVE MODE		[normal VALVE MODE]
CYCLE MODE		[normal CYCLE MODE]
SLOPE MODE		[normal SLOPE MODE]
SLOPE COUNT		[normal SLOPE COUNT]

#### ! CAUTION !

For 5.É. parameter, do not enter a value larger than **06** except when programming DELAY compensation (**5.É.=x4**).

## 5.4.3 SCHEDULE SELECT – 5.5.

The EN1000/EN1001 provides the user with four modes of SCHEDULE SELECT and/or initiation – INTERNAL (panel-dialed), EXTERNAL (non-panel, FS7/FS11 select), ANTI-TIE DOWN (panel-dialed, two-hands initiation), and EXTERNAL BINARY SELECT using S49 Option (50 non-panel, external schedules). The default (factory settings) mode is INTERNAL SCHEDULE SELECT.

To program the control for desired SCHEDULE SELECT mode:

1. Put the control in PROGRAM mode.
2. Use SELECT to find **ÉF**.
3. Use SCHEDULE push buttons to page through EXTENDED FUNCTIONS to find **5.5**.
4. Enter a value for **5.5**: of **00**, **01**, **02**, or **03** using the DATA push buttons.  
**Where:** **5.5.=00** for INTERNAL SCHEDULE SELECT (default)  
**5.5.=01** for EXTERNAL SCHEDULE SELECT  
**5.5.=02** for ANTI-TIE DOWN  
**5.5.=03** for S49 EXTERNAL BINARY SCHEDULE SELECT
5. Press the ENTER push button.

### 5.4.3 SCHEDULE SELECT – 5.5. (cont.)

#### INTERNAL SCHEDULE SELECT – 5.5.=00 (default)

In this mode, the initiation inputs (TS1-FS3, TS1-FS7, TS1-FS11) are dedicated as follows:

TS1-FS3 INITIATES ON ANY DISPLAYED SCHEDULE:

1. Select a schedule using the SCHEDULE push buttons.
2. Program the selected schedule or sequence.
3. Use **TS1-FS3** to initiate ANY schedule shown on the panel.

TS1-FS7 AUTOMATICALLY SELECTS AND INITIATES ON SCHEDULE 10:

1. Select schedule 10 using the SCHEDULE push buttons.
2. Program schedule 10 (or a sequence starting at schedule 10).
3. Use **TS1-FS7** to initiate schedule 10 (or a sequence starting at schedule 10).

#### NOTICE

Regardless of what schedule the Front Panel displays, TS1-FS7 is dedicated to initiate only on schedule 10.

TS1-FS11 AUTOMATICALLY SELECTS AND INITIATES ON SCHEDULE 20:

1. Select schedule 20 using the SCHEDULE push buttons.
2. Program schedule 20 (or a sequence starting at schedule 20).
3. Use **TS1-FS11** to initiate schedule 20 (or a sequence starting at schedule 20).

#### NOTICE

Regardless of what schedule the front panel displays, TS1-FS11 is dedicated to initiate only on schedule 20.

#### EXTERNAL SCHEDULE SELECT – 5.5.=01

In this mode, the initiation inputs (TS1-FS3, TS1-FS7, TS1-FS11) are dedicated as follows:

1. Select one of four schedules by an external device or operator acting on TS1-FS7 and TS1-FS11 as shown in Table 5-1.
2. Initiate the selected schedule using TS1-FS3.

**Table 5-1.** EXTERNAL SCHEDULE SELECT with FS7 and FS11

SCHEDULE	TS1-FS7/SS1	TS1-FS11/SS3	INITIATION
00	<b>OPEN</b>	<b>OPEN</b>	TS1-FS3
10	<b>CLOSED</b>	<b>OPEN</b>	TS1-FS3
20	<b>OPEN</b>	<b>CLOSED</b>	TS1-FS3
30	<b>CLOSED</b>	<b>CLOSED</b>	TS1-FS3

#### ! CAUTION !

When 5.5. parameter is changed to 5.5.=00, schedules 10 and 20 are cleared.

#### NOTICE

In this mode, the operator cannot select schedules using the Front Panel in OPERATE mode and can only initiate using TS1-FS3. Binary selects TS1-FS7 and TS1-FS11 must be closed before initiation of TS1-FS3 and be opened after sequence is started or completed.

### 5.4.3 SCHEDULE SELECT – 5.5. (cont.)

#### Dual Two-stage Foot Switches with EXTERNAL SCHEDULE SELECT

The Dual Schedule and EXTERNAL SCHEDULE SELECT functions can be combined to allow initiations by means of 2 two-stage foot switches.

Use schedule 00 for the foot switch #1 sequence and schedule 10 for the foot switch #2 sequence.

The foot switches and additional diode assembly (A/N 600573) are connected to TS1 Terminal Strip (see Figure 5-8). The diode assembly may be substituted with most any silicon diode rated 1 A at 100 V.

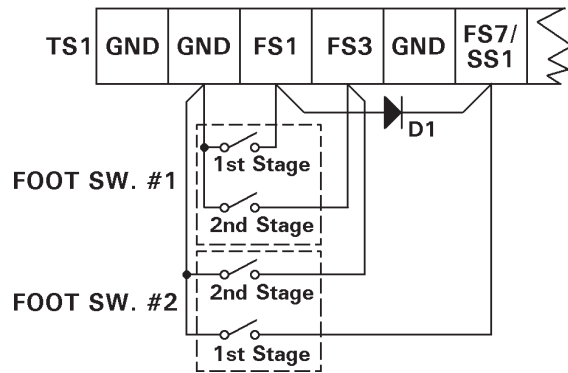


Figure 5-8. Dual two-stage foot switch initiation

#### Multiple Two-stage Foot Switches with EXTERNAL SCHEDULE SELECT

The Dual Schedule and EXTERNAL SCHEDULE SELECT functions can also be combined to allow initiations by means of multiple two-stage foot switches.

Use schedule 00 for foot switch #1 sequence, schedule 10 for foot switch #2 sequence, schedule 20 for foot switch #3 and schedule 30 for foot switch #4.\*

The foot switches and additional diodes (P/N 170012) are connected to TS1 Terminal Strip as shown in Figure 5-9. The diode assembly may be substituted with most any silicon diode.

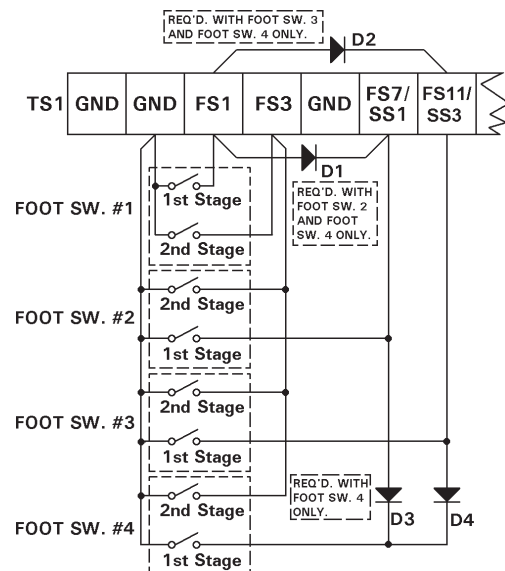


Figure 5-9. Multiple two-stage foot switch initiation

\* Similar connections can be used with S49 Option (see EXTERNAL BINARY SELECT Section).

#### ANTI-TIE DOWN MODE – 5.5.=02

When configuring the control for ANTI-TIE DOWN mode using the TS1 connections, the TS1-FS7/SS1 and TS1-FS11/SS3 terminals become inputs for ANTI-TIE DOWN initiations.

1. Use two single pole, normally open push button switches connected between TS1-FS7/SS1 and TS1-GND, and between TS1-FS11/SS3 and TS1-GND (see Figure 5-10).
2. Set the SCHEDULE SELECT EXTENDED FUNCTION to **5.5.=02**.

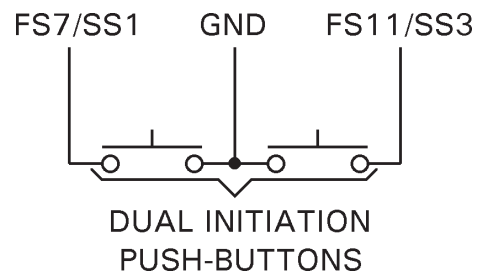


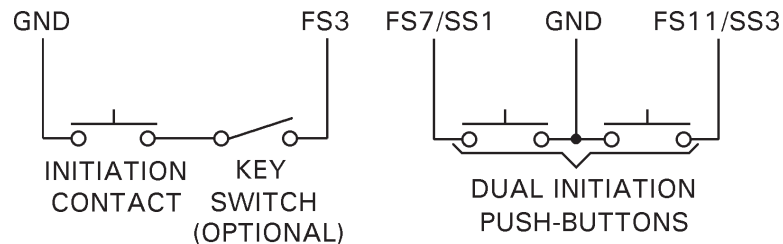
Figure 5-10. ANTI-TIE DOWN connections

### 5.4.3 SCHEDULE SELECT – 5.5. (cont.)

To initiate a weld using ANTI-TIE DOWN, both switches – TS1-FS7/SS1 and TS1-FS11/SS3 – must be closed within 0.5 seconds of each other. If both TS1-FS7 and TS1-FS11 switches are not closed within 0.5 seconds of each other, the control will show  $E.r.=[- -]$ . This error will be cleared after releasing remained closed initiations.

With ANTI-TIE DOWN operation, the machine electrodes will retract if either or both initiation push buttons are released before the end of SQUEEZE time.

To provide both ANTI-TIE DOWN (dual push button) and Single Contact initiations (with lockout), terminals TS1-FS3, TS1-FS7/SS1, and TS1-FS11/SS3 may be connected as shown in Figure 5-11. Only the displayed schedule will initiate by either pressing the TS1-FS3 single switch or by using the ANTI-TIE DOWN initiation mode (TS1-FS7/SS1 and TS1-FS11/SS3).



**Figure 5-11.** Single Contact and ANTI-TIE DOWN initiations

#### NOTICE

The ANTI-TIE DOWN feature affects CHAINED schedules. It is required that the operator's two hands be on the two palm buttons while the electrodes are closing on the parts to be welded. The palm buttons must be held until the end of the last programmed SQUEEZE time. Otherwise the electrodes will retract prematurely.

Any schedule executed which activates a *new* valve (CHAINED mode) requires the operator to keep both hands on the switches until after the SQUEEZE time of the last schedule that adds any new valves.

### Using ANTI-TIE DOWN Mode with S49 Option

If S49 Option Board is present and connected to the Control Board, multiple schedule selection is possible in this mode. After power-up, the control will automatically detect S49 Board if present and it will enable EXTERNAL BINARY SCHEDULE SELECT in ANTI-TIE DOWN mode if **5.5.=02**.

#### NOTICE

Starting with PROM firmware version 619016-002S, EXTERNAL BINARY SCHEDULE SELECT (only using S49 Option) is enabled in ANTI-TIE DOWN mode.

### EXTERNAL BINARY SELECT – S49 OPTION – 5.5.=03

In order to program this EXTENDED FUNCTION parameter **5.5.=03**, the S49 Option must be present and connected to the Control Board. The option consists of a J4 ribbon cable, an additional PCB 410329-004 with six binary schedule select inputs and Control Board 600572-009 (EN1001)

### 5.4.3 SCHEDULE SELECT – 5.5. (cont.)

or 600541-009 (EN1000) – see Appendix C for installation instructions. These six dry contact closure inputs (approximately 24 VDC) make all 50 schedules remotely available to the operator or machine process control system.

In this mode, initiation inputs (TS1-FS3 and S49 Option PCB TS12-SS1 through TS12-SS32) are dedicated as follows:

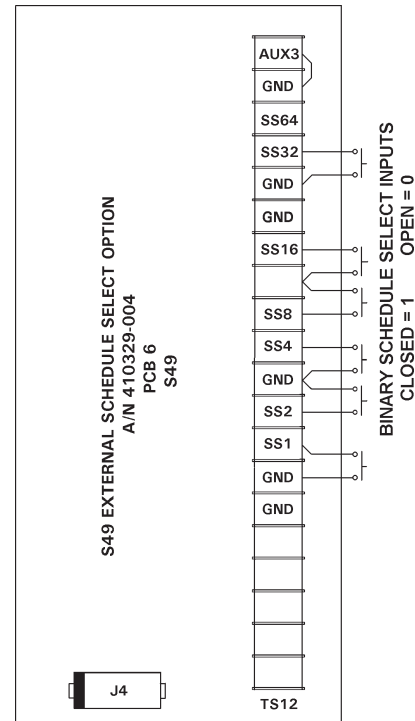
1. Select one of 50 schedules by an external device or operator acting on TS12-SS1 through TS12-SS32. See Switch Closure Connections diagram (Figure 5-12) and corresponding SCHEDULE SELECT table (Table 5-2).
2. Initiate sequence beginning with the selected schedule using TS1-FS3.

**NOTICE**

In this mode, the operator cannot select schedules using the Front Panel in OPERATE mode and can only initiate sequence beginning with dialed schedule using TS1-FS3. Function of the other two initiation inputs TS1-FS7 and TS1-FS11 is unchanged; i.e., TS1-FS7 is dedicated to initiate only on schedule 10, and TS1-FS11 is dedicated to initiate only on schedule 20.

**NOTICE**

If binary inputs provide decimal equivalent of 50 or above, control will display schedule 49.



**Figure 5-12.** Switch closure connections

**Table 5-2.** S49 EXTERNAL SCHEDULE SELECT  
DECIMAL (SCHEDULE) TO BINARY (TS12-SS1 through TS12-SS32)

SCHED	SS1	SS2	SS4	SS8	SS16	SS32	SCHED	SS1	SS2	SS4	SS8	SS16	SS32
00	0	0	0	0	0	0	25	1	0	0	1	1	0
01	1	0	0	0	0	0	26	0	1	0	1	1	0
02	0	1	0	0	0	0	27	1	1	0	1	1	0
03	1	1	0	0	0	0	28	0	0	1	1	1	0
04	0	0	1	0	0	0	29	1	0	1	1	1	0
05	1	0	1	0	0	0	30	0	1	1	1	1	0
06	0	1	1	0	0	0	31	1	1	1	1	1	0
07	1	1	1	0	0	0	32	0	0	0	0	0	1
08	0	0	0	1	0	0	33	1	0	0	0	0	1
09	1	0	0	1	0	0	34	0	1	0	0	0	1
10	0	1	0	1	0	0	35	1	1	0	0	0	1
11	1	1	0	1	0	0	36	0	0	1	0	0	1
12	0	0	1	1	0	0	37	1	0	1	0	0	1
13	1	0	1	1	0	0	38	0	1	1	0	0	1
14	0	1	1	1	0	0	39	1	1	1	0	0	1
15	1	1	1	1	0	0	40	0	0	0	1	0	1
16	0	0	0	0	1	0	41	1	0	0	1	0	1
17	1	0	0	0	1	0	42	0	1	0	1	0	1
18	0	1	0	0	1	0	43	1	1	0	1	0	1
19	1	1	0	0	1	0	44	0	0	1	1	0	1
20	0	0	1	0	1	0	45	1	0	1	1	0	1
21	1	0	1	0	1	0	46	0	1	1	1	0	1
22	0	1	1	0	1	0	47	1	1	1	1	0	1
23	1	1	1	0	1	0	48	0	0	0	0	1	1
24	0	0	0	1	1	0	49	1	0	0	0	1	1

1 = CLOSED 0 = OPEN

TS12-SS1 through TS12-SS32 require 24 VDC at 50 mA contacts

### 5.4.3 SCHEDULE SELECT – 5.5. (cont.)

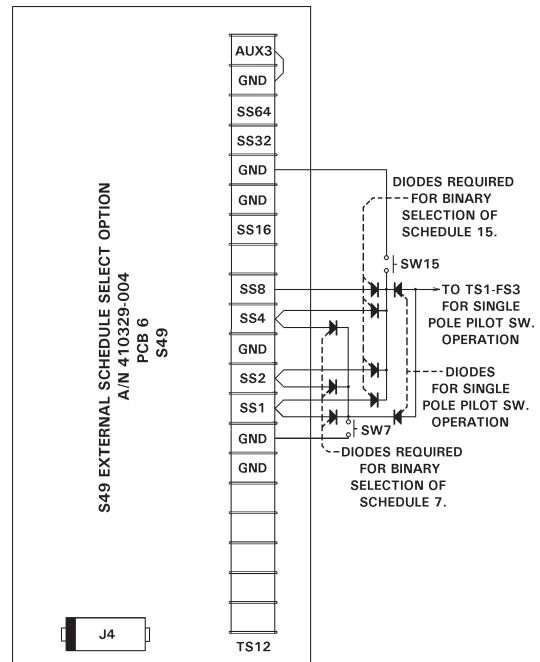
#### Multiple Pilot Operation

The EN1000/EN1001 can be configured to allow multiple pilot switches to initiate multiple schedules using the S49 Option. Once the control is put into the EXTERNAL BINARY SELECT mode (**5.5.=03**), a switch closure between TS1-FS3 and TS1-GND initiates the schedule externally selected via TS12-SS1 through TS12-SS32.

Additional pilot circuits can be accomplished by the addition of diodes. Each new pilot circuit will require at least two diodes and a single pole, normally open, momentary type switch. Refer to the Multiple Pilot Switch Connections diagram (Figure 5-13) during the following discussion.

The schedule selected by each new pilot switch is determined by the diodes connected to the schedule select inputs. In the diagram, SW7 initiates schedule 07. Notice there is a diode connected to SS1, SS2, and SS4; if these are added together, they equal 7 ( $1 + 2 + 4 = 7$ ). SW15 will initiate schedule 15 as the diodes are connected to SS1, SS2, SS4, and SS8. Any schedule (00 to 49) can be selected in this way. To select schedule 49, a diode is connected to SS1, SS16, and SS32.

These examples can be combined and thus several pilots can select several schedules. It is possible to connect more than one pilot circuit to the same schedule select terminals. Therefore, it is possible to have one pilot initiate schedule 07 (SS1, SS2, SS4) and another pilot initiate schedule 15 (SS1, SS2, SS4, SS8).



**Figure 5-13.** Multiple pilot switch connections

#### Operation Using Stepper

When the control is programmed for Stepper use, the S49 Option automatically changes to select steppers directly. In this case, the schedule select inputs could be re-labeled: SS00, SS10, SS20, SS30, and SS40. This functionality allows for the automatic external selection of any of the five available steppers and subsequent initiation. This offers extra flexibility when a weld gun changes fixtures in the middle of a job. In that case, it is not necessary to reset the Stepper for a new fixture until its assigned Stepper program is really completed.

As Table 5-3 shows, only one input is necessary for each stepper. This helps economize on PLC outputs otherwise necessary to select schedule for any of five steppers.

**Table 5-3.** Stepper selection using SS1, SS2, SS4, SS8

STEPPER	SCHEDULE	SS1	SS2	SS4	SS8	INITIATION
A	00	0	0	0	0	TS1-FS3
B	10	1	0	0	0	TS1-FS3
C	20	0	1	0	0	TS1-FS3
D	30	0	0	1	0	TS1-FS3
E	40	0	0	0	1	TS1-FS3

### 5.4.3 SCHEDULE SELECT – 5.5. (cont.)

#### Operation In SEAM Mode

In SEAM mode, this option offers the ability to switch from any schedule to any other schedule on the fly. When the control is in the SEAM mode (**SE=01**), it will respond to any of the available inputs and select the schedule requested by the input board signals. However, during a seam weld, the control can be commanded on the fly to change heats as it welds. This allows for extreme flexibility, since all 50 schedules can be selected automatically using a PLC or other dedicated input means (see Multiple Pilot Operation).

For example, a part to be welded requires schedules 00 and 01. A second, larger part requires schedules 10 and 11. The PLC can select schedule 00 before beginning the weld and switch to 01 whenever appropriate during the weld. It can just as easily select 10 before beginning the weld, and switch to 11 whenever appropriate during that weld. Ultimately, the application dictates the schedule selected.



## 5.4.4 AUTOMATIC VOLTAGE COMPENSATION AND MONITORING – *ℓ.ℓ.*

In addition to the original AUTOMATIC VOLTAGE COMPENSATION (AVC), an additional series of settings are available in the EN1000 or EN1001 Controls with PROM firmware version 619016-002A or later. The new settings allow voltage monitoring, or compensation and monitoring.

To program AUTOMATIC VOLTAGE COMPENSATION (AVC) or VOLTAGE MONITORING (AVM):

1. Put the control in PROGRAM mode.
2. Click SELECT until the DATA display shows **EF**.
3. Click the left SCHEDULE push button until the SCHEDULE display shows **ℓ.ℓ.**
4. Use the DATA push buttons and the tables below to program the desired values.
5. Press ENTER.

Original AVC settings are shown in Table 5-4. These settings are available on all controls, but they can be used only for compensation, not for monitoring.

**Table 5-4.** *Original AVC values*

AVC parameter <i>ℓ.ℓ.</i>	Line Voltage in VAC
00	AVC disabled
01	110
02	230
03	380
04	460
05	575

Additional AVC and AVM settings are shown in Table 5-5. These settings are available only on controls with PROM firmware version 619016-002A or later.

**Table 5-5.** *AVC parameter values*

AVC parameter <i>ℓ.ℓ.</i>		THRESHOLD
MONITORING & COMPENSATION	MONITORING ONLY	
10	11	+/- 3%
12	13	+/- 5%
14	15	+/- 10%
16	17	+/- 15%
18	19	+/- 20%
20	21	+/- 25%
22	23	+/- 30%
24	25	+/- 35%
26	27	+/- 40%
28	29	+/- 45%
30	31	+/- 50%

The AUTOMATIC VOLTAGE COMPENSATION uses a nominal set point value to determine whether the line voltage is changing during idle periods (between welds). The AVC (*ℓ.ℓ.*) values must be set during a time in which the line voltage is at this nominal value. For example, if the steady state line voltage is approximately 480 VAC, do not program *ℓ.ℓ.* until the line voltage is as close to 480 VAC as possible.

#### 5.4.4 AUTOMATIC VOLTAGE COMPENSATION & MONITORING – **C.C.** (cont.)

If nominal set point value is too low or too high compared to nominal voltage level, the control will display one of the following errors:

- E.r.=17** AVC nominal set point voltage is too low compared to nominal voltage level
- E.r.=18** AVC nominal set point voltage is too high compared to nominal voltage level

To clear these errors, simply press any push button. If either of these two errors occur during **C.C.** programming, the control will not enable AVC; i.e., **C.C.** will remain zero.

If AVC is enabled, the control monitors relative line voltage changes from the nominal set point. If the control detects line voltage changes, it will average these values. When the control is initiated to weld, it compares nominal relative voltage and measured average values to make a correction in the firing angle used for the weld; i.e., to compensate for any line voltage changes.

For **C.C.** values of **10** to **31**, the threshold values determine a window within which error messages are not triggered. These values are valid for any voltage level from 110 VAC to 575 VAC, since the control uses nominal set point. Any time when **C.C.** is reprogrammed, nominal voltage set point will be reset.

If the line voltage surpasses the threshold, the control will display an error announcing that the line voltage threshold has been exceeded. If measured average voltage is lower than low window (nominal set points minus threshold), or higher than high window (nominal set points plus threshold), the control will display one of the following errors:

- E.r.=19** average voltage is below low window (below nominal set point minus threshold)
- E.r.=20** average voltage is above high window (above nominal set point plus threshold).

To clear these errors, simply press any push button.

Several PROCESS OUTPUTS may be programmed for AVC and AVM. If either ERROR **19** or **20** occurs, the control will continue or stop the sequence depending on **P.O.** value:

- P.O.=12** Display error for 30 cycles (0.5 seconds) and **continue** with sequence. Valve 3 is **off**.
- P.O.=10, 13, or 17** Display error, turn **on** Valve 3 for 30 cycles (0.5 seconds) and **continue** with sequence.
- P.O.=14** Display error, turn **on** Valve 3, and **stop** the sequence.

## 5.4.5 CLEAR ALL FUNCTIONS – C.A.

It is sometimes desirable to CLEAR ALL previous SCHEDULES and EXTENDED FUNCTIONS from the memory and return the programmed parameters to factory defaults.

To use the CLEAR ALL feature:

1. Put the control in PROGRAM mode.
2. Use SELECT to find **EF**.
3. Use the SCHEDULE push buttons to find **C.A.**
4. Enter a value for **C.A.** of **01**.
5. Press the ENTER push button to clear all SCHEDULE data.
6. Enter a value for **C.A.** of **02**.
7. Press the ENTER push button to clear EXTENDED FUNCTIONS data.
8. Press PROGRAM/OPERATE push button to return the control to OPERATE mode.

### NOTICE

**ONCE THE CLEAR ALL FUNCTION IS EXECUTED,  
ERASED DATA CANNOT BE RESTORED.**

### SHORTCUT TO CLEAR DATA FOR DISPLAYED SCHEDULE

1. Put the control in PROGRAM mode.
2. Press and hold ENTER.
3. Click the PROGRAM/OPERATE button.

All SCHEDULE data for the displayed schedule will be erased.

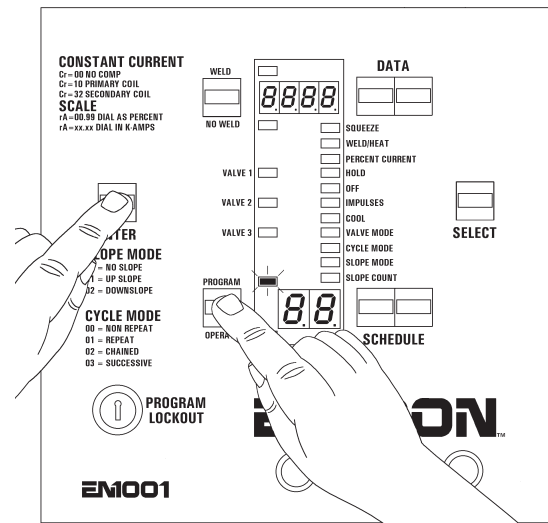


Figure 5-14. Clear SCHEDULE data

### SHORTCUT TO CLEAR ALL EXTENDED FUNCTIONS FROM CONTROL

1. Remove all power to the control.
2. Press and hold the PROGRAM/OPERATE push button.
3. Reapply power to the control.

All EXTENDED FUNCTIONS parameters in the control have been erased.

### NOTICE

After firmware updates in the field, a one-time CLEAR ALL is required when upgrading to a new version of firmware on **ALL** older Control Boards.

## 5.4.6 BACK-STEP / TEMPERATURE LIMIT SWITCH – b.5.

The BACK-STEP function is designed to add flexibility while welding with SUCCESSIVE schedules. While active, **b.5.** steps back to the previous schedule, and allows the operator to initiate on that schedule again while in the middle of a SUCCESSIVE sequence.

As an example, suppose the control executes a sequence and automatically advances the schedule number and flashes schedule **03**. But the operator has executed the sequence in the NO WELD mode. In this case, the operator must use the BACK-STEP switch to step back from schedule **03**, put the control in the WELD mode and re-initiate on schedule **02**.

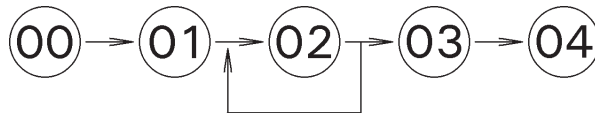


Figure 5-15. BACK-STEP sequence example

To connect the control for BACK-STEP operation, use a normally open switch between TS1-TLS1/AUX1 and TS1-GND on the Terminal Strip as a BACK-STEP input.

To program the control for BACK-STEP operation:

1. Put the control in PROGRAM mode.
2. Use SELECT to find **EF**.
3. Use the SCHEDULE push buttons to find **b.5.**
4. Enter a value for **b.5.** of **01** using the DATA push buttons.
5. Press the ENTER push button.

When in the BACK-STEP mode of operation, the switch connected between TS1-TLS1/AUX1 and TS1-GND must be open for normal operation, and momentarily closed to BACK-STEP one schedule. If left closed, the DATA display will show ERROR CODE **06** and the SCHEDULE display will show **E.r.** The control has configured TS1-TLS1/AUX1 to TS1-GND as an input which looks for a momentary closure.

### NOTICE

If BACK-STEP remains active for more than 1.5 seconds, it will cause the control to return to the first schedule of either a SUCCESSIVE or CHAINED series and display a flashing **E.r.=06**; ERROR CODE will remain while BACK-STEP contact is held closed.

To restore the control for TEMPERATURE LIMIT SWITCH operation (default setting):

1. Put the control in PROGRAM mode.
2. Use SELECT to find **EF**.
3. Use the SCHEDULE push buttons to find **b.5.**
4. Enter a value for **b.5.** of **00** using the DATA push buttons.
5. Press the ENTER push button.

### NOTICE

If PROCESS OUTPUT **#** has been selected, the PO output (SV5-SV6) will become energized when switching back to TEMPERATURE LIMIT SWITCH mode. If the control is using the RETRACTION PROCESS OUTPUT (**P.O.=08**), terminal TS1-TLS1/AUX1 is used as an input, thus BACK-STEP is not available.

## 5.4.6 BACK-STEP / TEMPERATURE LIMIT SWITCH – b.5. (cont.)

### USING BOTH TEMPERATURE LIMIT SWITCH AND BACK-STEP FUNCTION

If a Temperature Limit Switch is being used, it can be connected to TS1-NW1 and TS1-GND. This is the External Weld/No Weld input. If this switch is open, the control will be in a NO WELD condition.

#### NOTICE

The Back-Step Switch replaces the TLS operation. Alternatively, the Temperature Limit Switch should be connected in series with the Water Flow Switch (WFS) or connect the Temperature Limit Switch to the External Weld/No Weld input (NW1) while using the BACK-STEP option.

## 5.4.7 PROCESS OUTPUTS – P.O.

The EN1000 and EN1001 provide an output that can be useful when the operator or the system needs feedback from specific parts of the welding sequence, such as: major or minor error conditions to machine controls, shunt trips, or indicator lamps. Some PROCESS OUTPUTS may result in changes of the control sequence, status, fault, or major or minor error conditions. These changes are intentional with the objective of providing designers with complete flexibility. See Table 5-6 for the data codes available.

To use any PROCESS OUTPUT mode:

1. Put the control in PROGRAM mode.
2. Use SELECT to find **EF**.
3. Use the SCHEDULE push buttons to find **P.O.**
4. Use Table 5-6 as a guide for the necessary PROCESS OUTPUT code.
5. Press the ENTER push button.

Valve 3 may be connected to the shunt trip of a circuit breaker. Under certain conditions as listed below, when a shunt trip breaker is tripped, it is the same as removing power from the control. Most breakers can be equipped with a 110 VAC input shunt trip device. Refer to Section 4.3 and the appropriate Wiring Diagram.

#### ! WARNING !

Installation of Jumper JB between TS3-1 and TS3-VL1 will allow programming of Valve 3 output per Table 5-6.

**Exercise caution when programming since the result of its activation could cause a personnel hazard.**

The jumper between TS3-1 and TS3-VL1 is necessary to bypass the Valve Control Relay normally incorporated in the standard operation of Valve 3.

Table 5-6 summarizes all PROCESS OUTPUT codes. Detailed descriptions of each PROCESS OUTPUT follow the table.

## 5.4.7 PROCESS OUTPUTS – P.O. (cont.)

Table 5-6. PROCESS OUTPUT codes and descriptions

CODE	PROCESS OUTPUT DESCRIPTION
00	PROCESS OUTPUT disabled
01	ON during WELD
02	ON during WELD and HOLD
03	ON during HOLD
04	ON during OFF
05	ON after OFF until initiation is removed
06	ON for 0.5 seconds after EOS (END OF SEQUENCE)
07	Special AIR OVER OIL RETRACTION
08	RETRACTION mode
09	HALF CYCLE WELD mode
10	ON during any ERROR <i>or</i> control in NO WELD <i>or</i> control in PROGRAM mode <i>or</i> control in Emergency Stop <i>or</i> in CONSTANT CURRENT mode if current out of limit window
11	ON when Temperature Limit Switch is OPEN ( <b>E.r.=01</b> )
12*	Flash <b>H. i./L.o.</b> if current out of limit window
13*	Flash <b>H. i./L.o.</b> and Valve 3 ON for 0.5 seconds if current out of limit window
14*	Flash <b>H. i./L.o.</b> and break sequence if current out of limit window
15	ON for HARDWARE ERROR <i>or</i> CONTROL RELAY ERROR
16	ON for shorted SCR <i>or</i> L2 missing ERROR ( <b>E.r.=25</b> )
17	ON for: TLS ERROR, Memory ERROR, AVC ERRORS, END OF STEPPER, etc.
18	ON when SCR full conduction is detected ( <b>E.r.=13</b> )
19	ON during WELD only in WELD mode and closed NW1-GND input on TS1
20	ON after SQUEEZE and during WELD (for welder interlock)
21	– reserved –
22*	Send HI/LO and current after out of limit window weld or last weld in sequence with RS232 or RS485 Option
23*	Send HI/LO and current if current out of limit window with RS232 or RS485 Option
24*	Flash and indicate <b>H. i./L.o.</b> if current out of limit window and show CURRENT
25*	Indicate <b>H. i./L.o.</b> and EOS; show CURRENT on DATA display
26*	Flash <b>H. i./L.o.</b> , stop sequence in HOLD, holding part if current out of limit window
27*	Flash <b>H. i./L.o.</b> , break sequence and turn Valve 3 ON for 0.5 seconds if current out of limit window
28*	Indicate EOS: turn Valve 3 ON for 0.5 seconds if current is <b>within</b> limit window and control in WELD mode and closed NW1-GND input on TS1
29	– reserved –
30	ON if ERROR <b>36</b> (IPSC or IPS error) occurs
31	ON if ERROR <b>36</b> (IPSC or IPS error) occurs at the end of weld

\* **ONLY** available with EN1001 Controls.

#### 5.4.7 PROCESS OUTPUTS – P.O. (cont.)

- P.O.=00**    **PROCESS OUTPUT disabled** – No PROCESS OUTPUT programmed.
- P.O.=01**    **ON during WELD** – Valve 3 output will be **ON during WELD time** part of the sequence, regardless whether the control is in WELD or NO WELD mode.
- P.O.=02**    **ON during WELD and HOLD** – Valve 3 output will be **ON during application of WELD CURRENT and the programmed HOLD time.**
- P.O.=03**    **ON during HOLD** – Valve 3 output will be **ON during the programmed HOLD time.**
- P.O.=04**    **ON during OFF** – Valve 3 output will be **ON during the programmed OFF time** (only valid in REPEAT sequences).
- P.O.=05**    **ON after OFF until INITIATION is removed** – Valve 3 output will turn **ON after the programmed OFF time** has elapsed and **remain ON until the initiation is removed** from FS3, FS7 or FS11.
- P.O.=06**    **ON for 0.5 seconds after EOS (END OF SEQUENCE)** – Valve 3 output will turn **ON after the sequence is complete and remain ON for 0.5 seconds.**
- P.O.=07**    **Special AIR OVER OIL RETRACTION** – The operator can access additional EXTENDED FUNCTIONS parameter **BLOCKING DELAY (b.l.)**.
- P.O.=08**    **RETRACTION mode** – Valve 3 output will **toggle if TS1-TLS1/AUX1 is momentarily closed** to TS1-GND. The control will not initiate if this output is off. When Valve 3 is on, VALVE 3 indicator LED on the Front Panel will be blinking.
- P.O.=09**    **HALF CYCLE WELD mode** – When **P.O.=09** and **WELD=01**, the control will operate in HALF CYCLE mode. If WELD time is 2–99 cycles, control will weld for number of cycles programmed. In this mode, other control functions are affected: CYCLE MODE must be set to NON-REPEAT or SUCCESSIVE (use of REPEAT or CHAINED CYCLE MODES, with this option enabled, will result in full cycle waveforms); SLOPE time may not be entered in a schedule intended for use with HALF CYCLE welding (if SLOPE time is entered, with this option enabled, full cycle SLOPE time will be used for programmed time); in SEAM mode, the HALF CYCLE mode is disabled and full cycles will be used. For more details about HALF CYCLE mode, see Section 9.8, Appendix E and Appendix G.
- P.O.=10**    **ON during ANY ERROR or control in NO WELD or control in PROGRAM mode or control in Emergency Stop or in CONSTANT CURRENT mode if current out of HIGH/LOW limit window** – Valve 3 output will turn **ON under several conditions: 1) if any error is detected, 2) if control is in a NO WELD condition, 3) if control is in PROGRAM mode, or 4) in the event an Emergency Stop condition is detected.** May be useful when an automated machine is unattended. Under any circumstances, if there is an ERROR to be displayed by the control, Valve 3 output will be energized concurrently with the error message, or in STEPPER modes during END OF STEPPER message. This way, the control can advise an operator or a master PLC that an error has occurred. Also, an un-welded part cannot be fed into the machine following the welder if the PLC receives this signal and halts the subsequent process. Note that this signal will be active if the control is in NO WELD or in PROGRAM mode.

## 5.4.7 PROCESS OUTPUTS – P.O. (cont.)

- P.O.=10** (cont) In addition, when using PROM firmware version 619016-002R in CONSTANT CURRENT mode with this PROCESS OUTPUT, Valve 3 will be **ON during HOLD time if current out of HIGH/LOW limit window ERROR** occurs in any schedule of a welding sequence.
- P.O.=11** **ON when Temperature Limit Switch is OPEN** – Valve 3 output will be **ON when Temperature Limit Switch input TLS1 is open (E.r.=01)** detected.
- P.O.=12** **Flash H. i./L.o. if current out of limit window (EN1001 ONLY)** – DATA display will flash **H. i. or L.o.** when the control is unable to keep the current constant within the programmed HIGH/LOW limit window.
- P.O.=13** **Flash H. i./L.o. and Valve 3 ON if current out of limit window (EN1001 ONLY)** – DATA display will flash **H. i. or L.o.** when the control is unable to keep the current constant within the programmed HIGH/LOW limit window. In addition, Valve 3 output will turn **ON for 0.5 seconds**.
- P.O.=14** **Flash H. i./L.o. and break sequence if current out of limit window (EN1001 ONLY)** – DATA display will flash **H. i. or L.o.** when the control is unable to keep the current constant within the programmed HIGH/LOW limit window. In addition, the control will **stop a REPEAT or CHAINED sequence and put the control in NO WELD after the weld in which the error occurs**. If a sequence is interrupted, the Front Panel will flash **H. i./L.o.** message until the operator presses any push button. After clearing error message, WELD/NO WELD push button must be pressed in order to put control back in WELD mode. ***This PROCESS OUTPUT does not use Valve 3 for error indication – see P.O.=27 if Valve 3 is required.***
- P.O.=15** **ON for HARDWARE/CONTROL RELAY ERROR** – Valve 3 output will turn **ON if a Control Board ERROR** is detected.
- P.O.=16** **ON for shorted SCR or L2 missing ERROR** – Valve 3 output will turn **ON if shorted SCR or L2 missing ERROR (E.r.=25)** is detected.
- P.O.=17** **ON for: TLS ERROR/Memory ERROR/AVC ERRORS, END OF STEPPER, etc.** – Valve 3 output will turn **ON if following errors are detected: TLS ERROR, EEPROM ERROR, AVC ERRORS, during END OF STEPPER message in STEPPER modes, etc.**
- P.O.=18** **ON when SCR full conduction is detected** – Valve 3 output will be **ON if full SCR conduction error (E.r.=13)** is detected.
- P.O.=19** **ON during WELD only in WELD mode and closed NW1-GND input on TS1** – Valve 3 will be **ON during the WELD time of the sequence, only in WELD mode and closed NW1-GND input on TS1**. This PROCESS OUTPUT is the same as **P.O.=01**, except that Valve 3 will not be ON if control is in NO WELD mode or if NW1-GND input on TS1 is open.
- P.O.=20** **ON after SQUEEZE and during WELD** – Valve 3 output will be **ON after SQUEEZE and during application of WELD current**, regardless of whether control is in WELD or NO WELD mode. Can be used with welder interlocks (see Instruction Manual 700200).



#### 5.4.7 PROCESS OUTPUTS – P.O. (cont.)

- P.O.=22** Send HI/LO and CURRENT after out of limit window weld or last weld in sequence with RS232 or RS485 Option (EN1001 ONLY) – Will send data for out of limit window weld in sequence or last weld only in completed sequence to master on ENBUS or to serial printer. Display will flash **H. i.** or **L.o.** and measured CURRENT if out of limit window.
- P.O.=23** Send HI/LO and CURRENT if current out of limit window with RS232 or RS485 Option (EN1001 ONLY) – Will send data after weld if the current is out of limit window to master on ENBUS or to serial printer. Display will flash **H. i.** or **L.o.** and measured CURRENT.
- P.O.=24** Flash and indicate **H. i./L.o.** if current out of limit window and show CURRENT (EN1001 ONLY) – Uses Valve 1 to indicate HIGH current errors, Valve 2 for LOW current errors, and Valve 3 to indicate END OF SEQUENCE, displays measured CURRENT on DATA display after END OF SEQUENCE and displays **H. i.** or **L.o.** if measured current is out of HIGH/LOW limit window.
- P.O.=25** Indicate **H. i./L.o.** and EOS; show CURRENT on DATA display (EN1001 ONLY) – Uses Valve 1 to indicate HIGH current errors, Valve 2 for LOW current errors, and Valve 3 to indicate END OF SEQUENCE, and will display measured CURRENT on DATA display after END OF SEQUENCE.
- P.O.=26** Flash **H. i./L.o.**, stop sequence in HOLD, holding part if current out of limit window (EN1001 ONLY) – Uses Valve 3 to indicate HIGH or LOW current errors and stop the sequence until the error is cleared. Valve 1, if programmed, may be used to hold the part after the weld. Refer to Section 9.7 for more information.
- P.O.=27** Flash **H. i./L.o.**, break sequence, and turn Valve 3 ON if current out of limit window (EN1001 ONLY) – The same as **P.O.=14**, except that Valve 3 output will be ON for 0.5 seconds to indicate HIGH or LOW current.
- P.O.=28** Indicate EOS and turn Valve 3 ON if current within limit window and control in WELD mode and closed NW1-GND input on TS1 (EN1001 ONLY) – Valve 3 will be ON for 0.5 seconds at END OF SEQUENCE to indicate that current was *within* the HIGH/LOW limit window, and if control was in WELD mode with closed NW1-GND input on TS1. In NON-CONSTANT CURRENT mode, this PROCESS OUTPUT will turn Valve 3 ON for 0.5 seconds after EOS only if control was in WELD mode and closed NW1-GND input.
- P.O.=30** ON if ERROR 36 (IPSC or IPS error) occurs – When the control includes the IPSC or IPS option, the control may be programmed to turn Valve 3 ON to indicate whenever any PRESSURE error is detected.
- P.O.=31** ON if ERROR 36 (IPSC or IPS error) occurs at end of weld – When the control includes the IPSC or IPS option and uses this PROCESS OUTPUT, the control reads the sensor output after the WELD portion of the weld sequence and turns the Valve 3 ON if the TRIGGER value for PRESSURE/FORCE/CURRENT is not reached. The TRIGGER values must be programmed within a valid range.

## 5.4.8 BEAT OPERATION INITIATION MODES – *b.E.*

The EN1000/EN1001 Series Controls can provide several INITIATION modes:

- NON-BEAT INITIATION
- BEAT INITIATION DURING SQUEEZE
- BEAT INITIATION DURING SQUEEZE AND WELD
- BEAT INITIATION DURING WELD USING NW1 INPUT

### NON-BEAT INITIATION – *b.E.=00*

The default (factory setting) mode is NON-BEAT. In the NON-BEAT mode, once a sequence is initiated by a momentary switch closure, it cannot be stopped unless the Emergency Stop is opened.

To program the control for the default (factory setting) NON-BEAT mode:

1. Put the control in PROGRAM mode.
2. Use SELECT to find **EF**.
3. Use the SCHEDULE push buttons to find **b.E.**
4. Use the DATA push buttons and make **b.E.=00**.
5. Press ENTER.

### BEAT INITIATION DURING SQUEEZE – *b.E.=01*

BEAT DURING SQUEEZE is typically used with transgun applications. Generally, these applications may require that the operator or an external source terminate SQUEEZE time before entering the WELD period. This allows the operator to check tip placement before welding. If the placement is not correct, the initiation can be interrupted and the sequence can be terminated; the operator can then reposition the tip.

#### NOTICE

If initiation is opened during the WELD or HOLD period, the sequence will not be interrupted.

To program the control for BEAT DURING SQUEEZE:

1. Put the control in PROGRAM mode.
2. Use SELECT to find **EF**.
3. Use the SCHEDULE push buttons to find **b.E.**
4. Use the DATA push buttons and make **b.E.=01**.
5. Press ENTER.

#### NOTICE

To emulate a Two Stage Pilot, a Single Stage Pilot may be used in this mode of non-interlocked SQUEEZE time. If the Pilot is opened during the SQUEEZE, the control will immediately stop the sequence.

Once the WELD time begins, however, the control interlocks the pilot circuit and completes the sequence. Allow enough SQUEEZE time for the operator to check alignment during SQUEEZE and open the pilot circuit before the WELD time begins. This will allow the operator time to reposition the part if the alignment is not proper.

## 5.4.8 BEAT OPERATION INITIATION MODES – *b.E.* (cont.)

### BEAT INITIATION DURING SQUEEZE AND WELD – *b.E.=02*

BEAT DURING SQUEEZE AND WELD is typically used for brazing applications. It provides the same functions as provided by BEAT DURING SQUEEZE; in addition the weld sequence can be terminated before WELD time has elapsed. If the operator opens the initiation during WELD time, the WELD time is interrupted and the control immediately advances to HOLD time. If the initiation switch remains closed, however, the control will weld normally until the end of the programmed schedule.

This flexibility is required for brazing parts with differing characteristics that require different weld times. The WELD time must be set for the longest time required to bring the parts to the required brazing temperature.

To program for BEAT DURING SQUEEZE AND WELD:

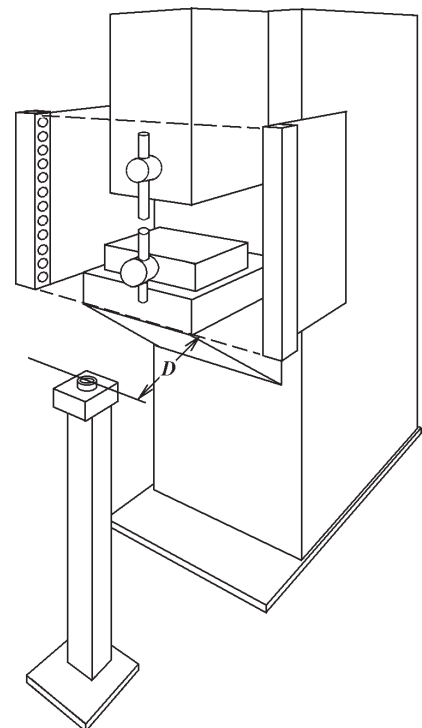
1. Put the control in PROGRAM mode.
2. Use SELECT to find **EF**.
3. Use the SCHEDULE push buttons to find **b.E.**
4. Use the DATA push buttons and make **b.E.=02**.
5. Press ENTER.

### **b.E. MODE – *b.E.=03* \***

In this mode, control will have faster response time after Emergency Stop or power-up, without redundant checking schedule data validity. It will eliminate all self-checking delays as well. This mode was added in PROM firmware version 619016-002J. It does not affect initiation and control will operate, after closing initiation, exactly the same as in default NON-BEAT mode (**b.E.=00**), except that control will be ready for initiation much faster. Faster initialization after closing Emergency Stop input may be very useful when light curtain is used.

When **b.E.** is set to **03**, the control will run a faster internal self-check after reset. This will reduce the time the control requires to go from an Emergency Stop condition to a Ready To Operate condition. This time will range from 30ms to 60ms maximum. To accomplish this reduced time, the redundant schedule data checking has been removed in this mode. The schedule data is still checked before use in a schedule when the weld sequence is initiated. The main reason for this addition is for machine control systems that use the TS1-ES1 and TS1-GND terminals to disable the weld control between initiations.

The standard recovery time of 200ms could add to machine cycle time if **b.E.** is not set to **03**. Before PROM firmware version 619016-002J, recovery time was around 500ms. This is especially apparent when light curtains, as shown in Figure 5-16, are used to activate the Emergency Stop circuit.



**Figure 5-16.** Using light curtain

\* This mode will not affect BEAT operation.

## 5.4.8 BEAT OPERATION INITIATION MODES – *b.E.* (cont.)

How far (D) would the initiation button need to be for reliable initiation? Using the following times:

1. Weld control EMERGENCY STOP response = 60 ms
2. Typical light curtain response = 50 ms
3. Typical speed of travel of hand used in calculations for light curtains is 63"/second

Distance (D) is calculated as follows:

$$D = \frac{63''}{1000 \text{ ms}} \times 110 \text{ ms} = 6.93''$$

This is an estimate based on typical values and does not include switch de-bounce times.

### BEAT INITIATION DURING WELD USING NW1 INPUT – *b.E.=04*

BEAT DURING WELD USING NW1 INPUT is enabled if *b.E.=04* is programmed. In this mode, when Weld/No Weld input (NW1-GND) is open, the control will stop welding and jump immediately to HOLD without executing the rest of the WELD part of the sequence.

### *b.E. MODE – b.E.=05 \**

In this mode, the control will allow programming of CYCLE MODE *05*. This mode was added in PROM firmware version 619016-002P. It does not affect initiation and control will operate, after closing initiation, exactly the same as in default NON-BEAT mode *b.E.=00*.

### *b.E. MODE – b.E.=06 \**

This mode is used for External Stepper Reset with momentary push button-type switch connected between TS1-ES1 and TS1-GND input. This mode was added in PROM firmware version 619016-002S.

\* This mode will not affect BEAT operation.

## 5.4.9 87° DELAY – *8.7.*

The 87° DELAY helps to prevent the build-up of a DC component in the welding transformer. A DC component may be damaging. To program this function:

1. Put the control in PROGRAM mode.
2. Use SELECT to find *EF*.
3. Use the SCHEDULE push buttons to find *8.7.*
4. Use the DATA push buttons and make *8.7.=00* or *01*.

**Where:** *00* = 87° DELAY is disabled

*01* = 87° DELAY is enabled – default (factory setting)

5. Press ENTER.

### NOTICE

87° DELAY ENABLE or DISABLE is only operational in MANUAL POWER FACTOR mode of operation (see Section 5.4.10).

## 5.4.10 MANUAL POWER FACTOR PROGRAMMING – *P.P.*

If required, the EN1000/EN1001 Control can be placed in the MANUAL POWER FACTOR mode as follows:

1. Place the control in the PROGRAM mode.
2. Use SELECT and find **EF**.
3. Use the SCHEDULE push buttons to find **P.P.**
4. Use the DATA push buttons to enter the machine's POWER FACTOR as measured following steps outlined in Section 5.4.11.  
**Where:** **P.P.=00** The control in AUTOMATIC POWER FACTOR mode (default).  
**P.P.=[xx]** If **xx** is not 00, the control is in MANUAL POWER FACTOR mode and the programmed POWER FACTOR is **xx**.
5. Press ENTER.

### NOTICE

When using the EN1001 Control in CONSTANT CURRENT mode, both AUTOMATIC POWER FACTOR and CONSTANT CURRENT function will compensate current. When the control operates under poor power factor and low PERCENT CURRENT output situation, the MANUAL POWER FACTOR should be set to 99% (**P.P.=99**) to obtain better performance.

## 5.4.11 POWER FACTOR MEASURING – *P.F.*

The EN1000/EN1001 Control is in the AUTOMATIC POWER FACTOR mode when shipped from the factory. Calibration of the automatic power factor circuit is not required. This has two benefits:

1. It is not necessary to make manual adjustments when installing the control, to match its circuitry to the POWER FACTOR of the welding machine;
2. It assures that maximum welding current, for any welding transformer tap switch setting, will occur when the selected PERCENT CURRENT is 99%.

If desired, for some applications, the AUTOMATIC mode can be disabled and the machine POWER FACTOR can be set manually (see Section 5.4.10). Machine's POWER FACTOR can be determined when in the AUTOMATIC POWER FACTOR mode as follows:

1. Use SELECT to find **EF**.
2. Use the SCHEDULE push buttons to find **P.F.**
3. Make a weld.

At this point, after the weld is complete, the machine's POWER FACTOR will be shown in the DATA display (see Section 5.4.10).

### NOTICE

When measuring the POWER FACTOR, the displayed POWER FACTOR corresponds to the last weld made by the control.

### 5.4.12 SQUEEZE DELAY – *5.d.*

SQUEEZE DELAY is a pre-squeeze which energizes the scheduled valves for the programmed interval of time. SQUEEZE DELAY occurs **after** initiation and immediately **before** the first SQUEEZE is executed (a form of retraction to position electrodes closer to the work in a REPEAT sequence).

The length of time added to SQUEEZE time measured in cycles (60 cycles = 1 second).

After initiation on any of the Pilot switches (FS3, etc.), the control's display will dim slightly indicating the control is in SQUEEZE DELAY and return to regular intensity for the programmed SQUEEZE time.

#### NOTICE

SQUEEZE DELAY occurs only before the first SQUEEZE time when in REPEAT mode.

### 5.4.13 BLOCKING DELAY – *b.l.*

This output enables the user of an air-over-oil gun to have a programmed partial retraction in the middle of a sequence. The output may be turned off by momentarily opening Emergency Stop terminals TS1-ES1 and TS1-GND.

BLOCKING DELAY is an interval of time that occurs **immediately before** (overlapping) the programmed OFF time interval.

When **P.O.=07** and delays have been programmed properly, Valve 3 output will turn on during the programmed OFF time, starting at the end of BLOCKING DELAY time. It will remain on after the current sequence until the next initiation occurs.

If the programmed OFF interval is shorter than the programmed BLOCKING DELAY interval, the programmed OFF will not occur.

If the programmed OFF interval is longer than BLOCKING DELAY, resulting OFF time will be programmed OFF time minus BLOCKING DELAY time (see Figure 9-15). This means that BLOCKING DELAY overlaps OFF (after HOLD, coincident with OFF time) which happens only in a sequence of schedules ending with a CYCLE MODE = **00**, **01** or **03**.

### 5.4.14 TURNS RATIO – *t.r.* (EN1001 *only*)

This parameter is used to set the TURNS RATIO of the transformer.

The TURNS RATIO is necessary when the control is set to PRIMARY CONSTANT CURRENT mode. When the control is set to PRIMARY CONSTANT CURRENT COMPENSATION or MONITORING mode, the control only measures the primary current from the sensor, and then calculates the secondary current by the following equation:

$$\text{Secondary Current} = \text{Primary Current} \times \text{Turns Ratio of transformer}$$

#### 5.4.14 TURNS RATIO – *t.r.* (EN1001 only) (cont.)

The minimum and maximum values of *t.r.* are 10 and 255. To program the TURNS RATIO for the control:

1. Put the control in PROGRAM mode.
2. Use SELECT push button to find *E.F.*
3. Use the SCHEDULE push buttons to find *t.r.*
4. Use the DATA push buttons to change the data.
5. Press ENTER.

See Section 8.2 for more information.

#### 5.4.15 CONSTANT CURRENT MODES – *c.r.* (EN1001 only)

This parameter is used to select desired CONSTANT CURRENT mode and Current Sensor. The EN1001 Constant Current Control can be programmed for CONSTANT CURRENT operation and two basic modes:

1. Compensation (both monitoring and compensation)
2. Monitoring (only monitoring, no compensation)

CONSTANT CURRENT operation is possible with two different types of Current Sensors:

- Primary Sensing with Current Transformer
- Secondary Sensing with calibrated Rogowski Coil

To program the control for CONSTANT CURRENT operation:

1. Put the control in PROGRAM mode.
2. Use SELECT to find *E.F.*
3. Use the SCHEDULE push buttons to find *c.r.*
4. Use DATA push buttons to select desired CONSTANT CURRENT code from Table 5-7.
5. Press the ENTER push button.

**Table 5-7. CONSTANT CURRENT modes**

<i>c.r.</i>	CONSTANT CURRENT	RANGE
00	disabled CONSTANT CURRENT	—
<b>Primary Current Transformer: PT2, PT5, PT10, or PT20</b>		
10	Primary Compensation w/any current transformer	Auto Range
11	Primary Monitoring w/any current transformer	Auto Range
12	Primary Compensation with PT2	Preset Range up to primary 200A
13	Primary Monitoring with PT2	Preset Range up to primary 200A
14	Primary Compensation with PT5	Preset Range up to primary 500A
15	Primary Monitoring with PT5	Preset Range up to primary 500A
16	Primary Compensation with PT10	Preset Range up to primary 1 kA
17	Primary Monitoring with PT10	Preset Range up to primary 1 kA
18	Primary Compensation with PT20	Preset Range up to primary 2 kA
19	Primary Monitoring with PT20	Preset Range up to primary 2 kA
<b>Secondary Rogowski Coil: S6 or S10</b>		
30	Secondary Compensation	Auto Range up to 99.99 kA
31	Secondary Monitoring	Auto Range up to 99.99 kA
32	Secondary Compensation	2 to 99.99 kA
33	Secondary Monitoring	2 to 99.99 kA

### 5.4.15 CONSTANT CURRENT MODES – $C.R.$ (EN1001 *only*) (cont.)

More information about  $C.R.$  setting is described in Section 8.2.

EN1001 Controls in CONSTANT CURRENT mode can access  $H.L.$  and  $L.O.$  EXTENDED parameters to set specific current limits (see Section 8.3.2 for more information).

### 5.4.16 RANGE – $r.R.$ (EN1001 *only*)

This parameter is used in CONSTANT CURRENT mode to set the RANGE of the control's secondary current.

The value of  $r.R.$  should be or be close to the maximum secondary current of the control. When the control operates in different CONSTANT CURRENT modes, the RANGE has different minimum and maximum values as shown in Table 5-8.

When the control operates in AUTO-RANGE COMPENSATION mode ( $C.R.=10$  or  $C.R.=30$ ),  $r.R.$  can be set to 0.99; at this moment, the PERCENT CURRENT parameter in weld schedules can be set in percentage of control's maximum capability. This function is useful when the operator does not know the maximum value of secondary current.

To program RANGE on the EN1001 Control in CONSTANT CURRENT modes:

1. Put the control in PROGRAM mode.
2. Use SELECT to find  $EF$ .
3. Use the SCHEDULE push buttons to page through the EXTENDED FUNCTIONS and find  $r.R.$
4. Enter a value for  $r.R.$  from Table 5-8, using the DATA push buttons.
5. Press ENTER push button.

**Table 5-8.** Maximum and minimum values of  $r.R.$

$C.R.$	Minimum $r.R.$ [kA]	Maximum $r.R.$ [kA]
10, 11, 30 or 31	—	99.99
12 or 13	2	$t.r.$ (TURNS RATIO) x 0.2
14 or 15	2	$t.r.$ x 0.5 <i>or</i> 99.99 (choose minimum value)
16 or 17	2	$t.r.$ x 1 <i>or</i> 99.99 (choose minimum value)
18 or 19	2	$t.r.$ x 2 <i>or</i> 99.99 (choose minimum value)
32 or 33	2	99.99

#### NOTICE

The value of  $r.R.$  should be or be close to the maximum secondary current of the control's capability. Since the control will automatically adjust the embedded amplifier's gain according to the value of  $r.R.$ , improper setting of  $r.R.$  will cause overshooting or poor compensation quality during the current compensation process.

More information about  $r.R.$  setting is described in Section 8.2.



## 5.4.17 CURRENT OFFSET – *C.O.*

The EXTENDED FUNCTION parameter CURRENT OFFSET (*C.O.*) provides current adjustment in either [kA] or [%] in OPERATE mode without going into PROGRAM mode. With this parameter, an adjustment limit window is set within which the weld CURRENT can be changed. Only weld CURRENT can be changed this way and all other SCHEDULE parameters remain unchanged. There are two CURRENT OFFSET modes – CURRENT OFFSET FOR SINGLE DISPLAYED SCHEDULE, and CURRENT OFFSET FOR ALL SCHEDULES.

### 1. CURRENT OFFSET FOR SINGLE DISPLAYED SCHEDULES

Changing the CURRENT for a schedule only affects the displayed schedule. This is useful when a change is needed because of an individual part change.

### 2. CURRENT OFFSET FOR ALL SCHEDULES

Changing the CURRENT for any individual schedule, within the CURRENT OFFSET window, will affect *all* schedules (00-49) programmed in the control. Offsetting of all schedules may be useful when a machine function (i.e., a shunt) increases in resistance, affecting all weld schedules.

## CURRENT OFFSET PROGRAMMING FOR SINGLE DISPLAYED SCHEDULES

To program the CURRENT OFFSET limits for SINGLE DISPLAYED SCHEDULES:

1. Put the control in PROGRAM mode.
2. Click SELECT until the DATA display shows **EF**.
3. Click the left SCHEDULE push button until the SCHEDULE display shows **C.O.**
4. Use the DATA push buttons to program the desired values.

Where: **C.O.=00** CURRENT OFFSET is disabled  
**C.O.=01 to 19** CURRENT OFFSET is enabled ONLY for SINGLE DISPLAYED SCHEDULE

5. Press ENTER.

For a SINGLE DISPLAYED SCHEDULE, the CURRENT OFFSET may be any value from 01 to 19 in units of percent [%]. This value will set maximum and minimum OFFSET limits for programmed CURRENT. CURRENT can be changed within these limits without going into PROGRAM mode.

## CURRENT OFFSET PROGRAMMING FOR ALL SCHEDULES

To program the CURRENT OFFSET limits for ALL SCHEDULES:

1. Put the control in PROGRAM mode.
2. Click SELECT until the DATA display shows **EF**.
3. Click the left SCHEDULE push button until the SCHEDULE display shows **C.O.**
4. Use the DATA push buttons to program the desired values.

Where: **C.O.=20** CURRENT OFFSET is disabled  
**C.O.=21 to 39** CURRENT OFFSET is enabled for ALL SCHEDULES

5. Press ENTER.

### 5.4.17 CURRENT OFFSET – *C.O.* (cont.)

When CURRENT OFFSET FOR ALL SCHEDULES is used, *C.O.* can have a value from 20 to 39 as indicated below:

<b><i>C.O.</i> = 20</b>	CURRENT OFFSET is disabled
<b>= 21</b>	CURRENT OFFSET FOR ALL SCHEDULES ±1%
<b>= 22</b>	CURRENT OFFSET FOR ALL SCHEDULES ±2%
<b>= . . .</b>	
<b>= 38</b>	CURRENT OFFSET FOR ALL SCHEDULES ±18%
<b>= 39</b>	CURRENT OFFSET FOR ALL SCHEDULES ±19%

On Control Boards with four-digit DATA display, the first digit will be **S** if *C.O.*=**01** to **19** or **R** if *C.O.*=**21** to **39**.

### USING CURRENT OFFSET

This feature is very useful when a PROGRAM LOCKOUT key switch is used. An operator may change the CURRENT without changing any other welding parameters and without going into PROGRAM mode. The operator may increase the operating PERCENT CURRENT only up to BASE CURRENT plus CURRENT OFFSET, or decrease the operating PERCENT CURRENT down to BASE CURRENT minus CURRENT OFFSET.

To change programmed CURRENT, within the OFFSET limits in [%] or [kA], in OPERATE mode:

1. Click SELECT until FUNCTION indicator LED stops at PERCENT CURRENT.
2. Use the DATA push buttons to increase or decrease the PERCENT CURRENT by pressing or holding either DATA push button.
3. Press ENTER *only* for CONSTANT CURRENT mode in [kA]. For CONSTANT CURRENT mode in [%] or for NON-CONSTANT CURRENT mode, data will be stored immediately after pressing either DATA push button.

#### NOTICE

If a value greater than allowed by maximum OFFSET is programmed, the control will store and display maximum PERCENT allowed. Similarly, if a value lower than allowed by minimum OFFSET is programmed, the control will store and display minimum PERCENT allowed.

**CURRENT OFFSET FOR SINGLE DISPLAYED SCHEDULES – *C.O.*=01 to 19:** New weld PERCENT CURRENT will be only for that schedule.

**CURRENT OFFSET FOR ALL SCHEDULES – *C.O.*=21 to 39:** PERCENT CURRENT will be increased or decreased with the same OFFSET in percent in all schedules.

### CHANGING BASE CURRENT

To change BASE PERCENT CURRENT, simply program the schedule as done normally by switching to the PROGRAM mode and following normal programming procedures. In PROGRAM mode, the display will flash between BASE CURRENT and OFFSET CURRENT value. PERCENT CURRENT is the only weld schedule parameter that is changed whenever a CURRENT OFFSET value is used.

## 5.4.17 CURRENT OFFSET – *C.O.* (cont.)

### CURRENT OFFSET INDICATION

In the PROGRAM mode, when the PERCENT CURRENT is displayed, the control will flash if the CURRENT OFFSET is active. The programmed BASE CURRENT is indicated simultaneously with the schedule number. The OFFSET CURRENT is indicated simultaneously with *C.O.* in the SCHEDULE display plus either **S.** (Single Displayed) or **A.** (All) in the DATA display (NON-CONSTANT CURRENT mode) along with the OFFSET CURRENT value used.

The ENTER push button can be depressed while either of the two values are displayed. Pressing ENTER will move the OFFSET CURRENT value into the BASE PERCENT CURRENT value. BASE CURRENT value also may be changed by pressing or holding DATA push buttons and then pressing ENTER.

### CURRENT OFFSET EXAMPLES

1. ***C.O.=00*** CURRENT OFFSET is disabled. The CURRENT cannot be changed in OPERATE mode.
2. ***C.O.=05***  
or  
***C.O.=S.05***  
[%] mode CURRENT OFFSET is +/-5%. For SINGLE DISPLAYED SCHEDULE, the CURRENT can be changed in OPERATE mode within 10% window; i.e., up to +/-5% from original BASE value programmed in PROGRAM mode.  
For example: For an original BASE CURRENT value of 70%, a new value may be from 65% to 75%.
3. ***C.O.=25***  
or  
***C.O.=A.25***  
[%] mode CURRENT OFFSET is +/-5%. For ALL SCHEDULES, the CURRENT can be changed in OPERATE mode within 10% window; i.e., up to +/-5% from original BASE value programmed in PROGRAM mode.  
For example: For an original BASE CURRENT value of 70%, a new value may be from 65% to 75%.
4. ***C.O.=05***  
or  
***C.O.=S.05***  
[kA] mode CURRENT OFFSET is +/-5%. For SINGLE DISPLAYED SCHEDULE, the CURRENT can be changed in OPERATE mode within 10% of maximum RMS CURRENT window; i.e., up to +/-5% from original value programmed in PROGRAM mode.  
For example: For an original BASE CURRENT value of 14.00 kA and maximum RMS is 20.00 kA, a new value may be from 13.00 kA to 15.00 kA (because 5% of 20.00 kA is 01.00 kA).

## 5.4.18 PIN LOCKOUT MODE – P.n.

This feature has been added in PROM firmware version 619016-002N and does not require any hardware change or additional option. Operation of the hardware PROGRAM LOCKOUT key switch, when used, has not been changed.

### ENABLING PIN LOCKOUT

To enable PIN LOCKOUT mode, a 4-digit PIN number must be programmed:

1. Put the control in PROGRAM mode.
2. Click SELECT until the DATA display shows **EF**.
3. Scroll through EXTENDED FUNCTIONS using the right SCHEDULE push button until the SCHEDULE display shows **P.n**.
4. Use the DATA push buttons to program desired PIN from **0001** to **9999**.
5. Press ENTER.
6. Program all other desired SCHEDULE or EXTENDED FUNCTION parameters.
7. Put the control back in PROGRAM mode. After PROGRAM/OPERATE push button is released, the control will flash **L.o.c.** on DATA display, which will indicate that PIN LOCKOUT mode is enabled.

After the last step, control will be locked from going into PROGRAM mode. To unlock control, entering correct PIN is required or use of PROGRAM LOCKOUT key switch when used.

### UNLOCKING CONTROL USING PIN

In order to go in PROGRAM mode when control is locked, correct PIN must be entered:

1. Click SELECT until the DATA display shows **EF**.
2. Scroll through EXTENDED FUNCTIONS using the right SCHEDULE push button until the SCHEDULE display shows **P.n**. On DATA display, control will show **0000** as programmed PIN is hidden.

#### NOTICE

Whenever PROGRAM/OPERATE push button is pressed while control is locked with PIN, the control will flash **P. n.** for 0.5 seconds on DATA display and PROGRAM LED will flash as well, and control will go immediately to EXTENDED FUNCTION parameter **P.n**.

3. Use the DATA push buttons to enter PIN.
4. Press ENTER. After this push button is released:
  - if correct PIN is entered, the control will flash **u.l.o.c.** on DATA display and it will go immediately into PROGRAM mode;
  - if incorrect PIN is entered, the control will flash **O.o.P.S.** on DATA display.
5. After programming all desired SCHEDULE or EXTENDED FUNCTION parameters, new PIN may be entered or the current PIN will be applied when control is put back in OPERATE mode.

### DISABLING PIN LOCKOUT

To disable PIN LOCKOUT mode or delete PIN, simply clear all EXTENDED FUNCTIONS data by entering **C.R.=02**, or by pressing and holding PROGRAM/OPERATE push button during power-up or after Emergency Stop reset. This may be also very useful whenever the PIN is lost.

#### NOTICE

The control is shipped from the factory in the **disabled** PIN LOCKOUT mode.

## 6.0 GENERAL OPERATING INSTRUCTIONS

For customer's convenience, many electrical and mechanical connections have been performed at the factory. Refer to Wiring Diagram for other connections.

Be sure **ALL** electrical connections are properly made and that all fittings are securely tightened. Loose electrical connections can cause faulty or erratic operation of the control or welding machine.

If the machine is air operated, turn on the air supply to the machine. Set air pressure in accordance with the machine manufacturer's recommendations.

Be sure that the welding machine heads are fully retracted. Turn on main power. The SCHEDULE and DATA displays will turn on at this time.

Place the control in NO WELD. Use either the Front Panel's WELD/NO WELD push button or the External Weld/No Weld Switch connected to the Terminal Strip between TS1-NW1 and TS1-GND.

### 6.1 WELD SEQUENCE EXAMPLE

Program a simple single SPOT schedule into the control as follows:

SQUEEZE count	30 to 60 cycles
WELD/HEAT count	12 to 25 cycles
PERCENT CURRENT	50 to 60%
HOLD count	10 to 15 cycles
OFF count	00 cycles
IMPULSES	01 (NO IMPULSES)
COOL count	00 cycles
VALVE MODE	01 (VALVE 1)
CYCLE MODE	00 (NON-REPEAT)
SLOPE MODE	00 (NO SLOPE)
SLOPE COUNT	00 cycles

1. Initiate the control. On installations with a Two Stage Pilot switch, depress the First Stage only. The programmed valve will activate. The control will not sequence through SQUEEZE, WELD, HOLD and OFF. Be sure that the electrodes have closed together prior to depressing the Second Stage.
2. The control will sequence but will not weld, and then the head or arms will retract. On Single Stage operation, closure of the Pilot switch will cause the control to sequence. On foot-operated machines only, a switch on the mechanical linkage of the machine will initiate the sequence.

#### **! CAUTION !**

**KEEP HANDS, ARMS, OTHER PORTIONS OF THE BODY, CLOTHING, AND TOOLS AWAY FROM THE MOVING PARTS OF THE MACHINE.**

## 6.1 WELD SEQUENCE EXAMPLE (cont.)

3. Program the schedule for the part to be welded. Place the work in the machine and set the WELD/NO WELD switch (both on Control Panel and any External Weld/No Weld Switches) to the WELD position. The machine is ready to weld.
4. If no standards have been set, it is recommended to use a short WELD count for initial setup and welding. WELD count can be increased, the PERCENT CURRENT can be adjusted, and welding transformer tap (if applicable) can be increased for the best weld. The most efficient use of the control and welding machine will generally be made at the lowest welding transformer tap, the highest PERCENT CURRENT setting, and the shortest WELD count.
5. For REPEAT operation, program CYCLE MODE to **01**, and program OFF count to allow sufficient time to reposition the part for subsequent welds.

## 6.2 CYCLE MODES

The EN1000/EN1001 can be programmed to operate in several CYCLE MODES. Each of the 50 possible schedules has a CYCLE MODE parameter that dictates the sequence of events that will follow an initiation.

The CYCLE MODE are as follows:

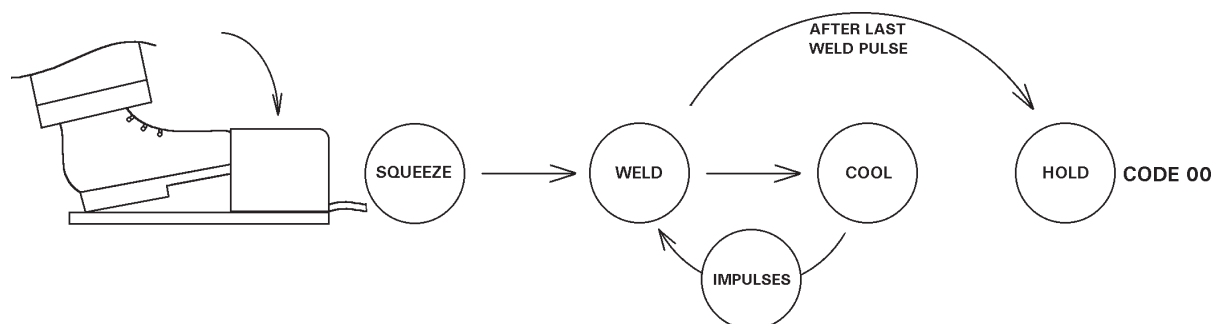
- 00** = NON-REPEAT
- 01** = REPEAT
- 02** = CHAINED
- 03** = SUCCESSIVE
- 04** = CONDITIONAL SUCCESSIVE
- 05** = WAIT-HERE

The CYCLE MODE parameter is entered into a schedule when the control is in PROGRAM mode with CYCLE MODE indicator LED illuminated.

### 6.2.1 NON-REPEAT – CYCLE MODE=00

When any of the 50 possible schedules, having a CYCLE MODE setting of **00**, is initiated by a Pilot switch, the sequence executes as shown in Figure 6-1 (depending on the programmed parameters).

Upon initiation, the programmed valve is energized at the beginning of SQUEEZE. If the Pressure Switch is open, the control counts through the SQUEEZE time but does not begin counting



**Figure 6-1.** *NON-REPEAT* sequence

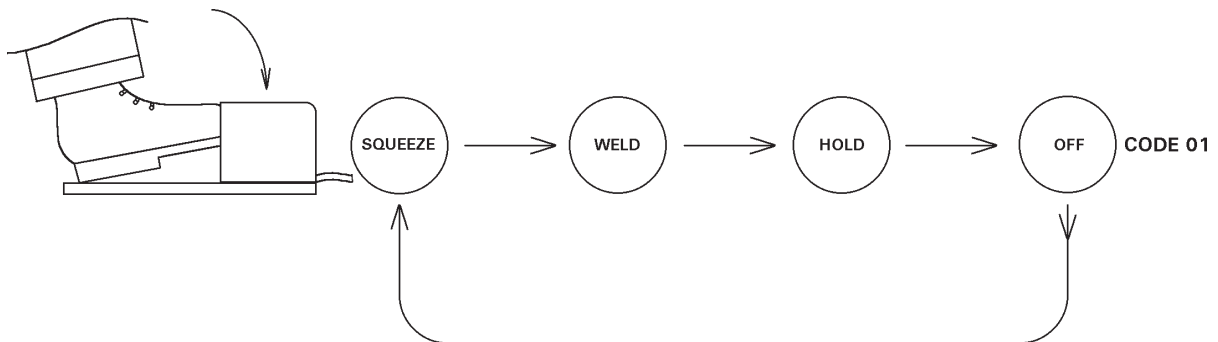
### 6.2.1 NON-REPEAT – CYCLE MODE=00 (cont.)

WELD time until the Pressure Switch closes. If the Pressure Switch remains open, the SQUEEZE LED will flash. Once the Pressure Switch closes, the WELD time begins. Weld current is then supplied to the welding transformer at a value programmed by the PERCENT CURRENT for a duration programmed in WELD.

In this example, PULSATION is shown after COOL, until the number of IMPULSES has elapsed, then moving to HOLD. HOLD time is when the electrodes are closed with no current present, but the selected valve will still be energized. Since this is a NON-REPEAT sequence, there is no OFF time mentioned. The valve will automatically de-energize at the end of the programmed HOLD time.

### 6.2.2 REPEAT – CYCLE MODE=01

When any of the 50 possible schedules, having a CYCLE MODE setting of **01**, is initiated by a Pilot switch, the sequence is as shown in the following diagram (Figure 6-2).



**Figure 6-2.** REPEAT sequence

In this example, the sequence is much the same as the previous example with the exception of no IMPULSE welding. If the initiation (foot switch) is held closed until after the OFF time, the control will move to the beginning of SQUEEZE time and REPEAT the scheduled sequence.

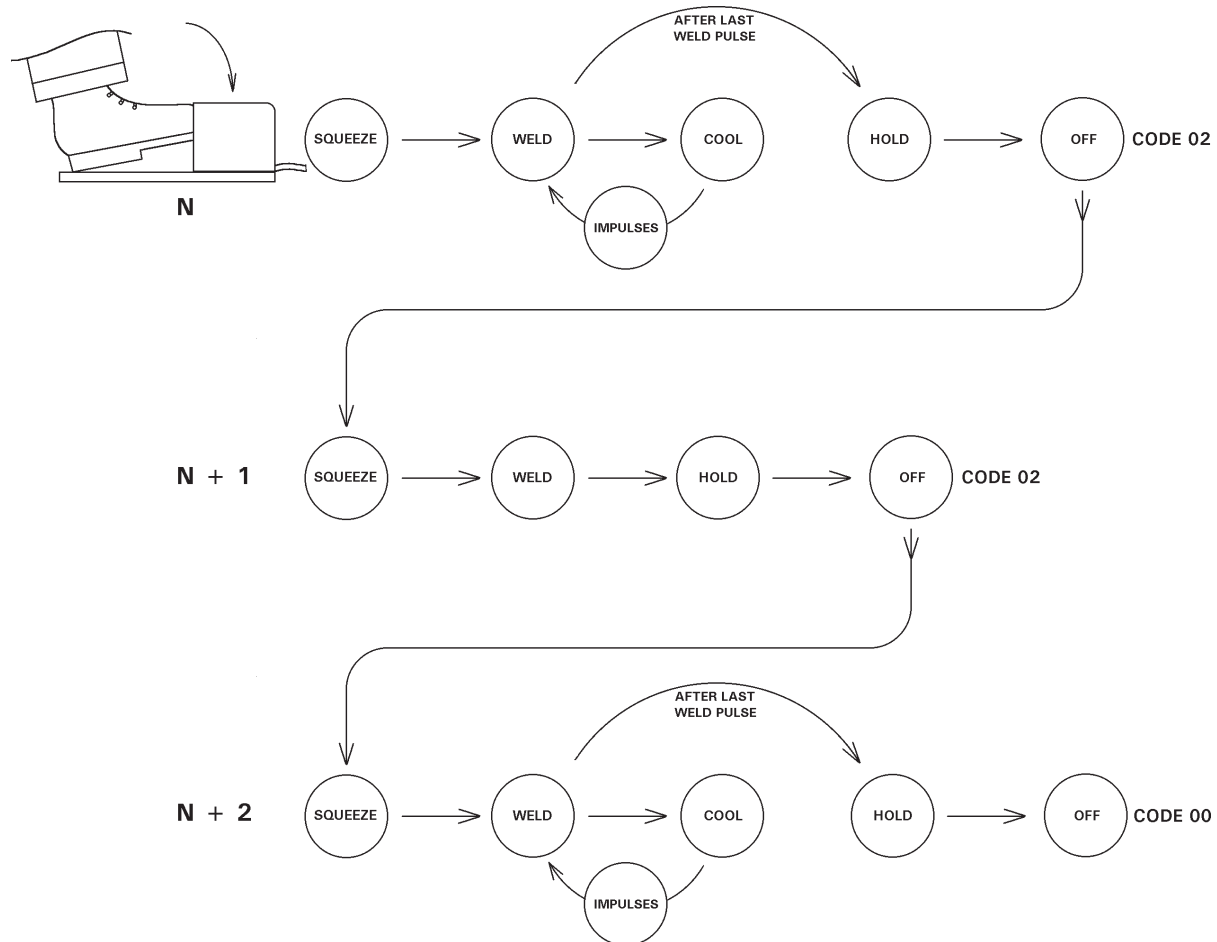
Each individual sequence intended to REPEAT must be programmed separately for CYCLE MODE **01** to perform a REPEAT function.

### 6.2.3 CHAINED – CYCLE MODE=02

Scheduled sequences may be CHAINED, resulting in a weld sequence made up of several schedules in length. A CHAINED sequence can be programmed by entering **02** in CYCLE MODE. The last scheduled sequence must be a CYCLE MODE value of **00** (NON-REPEAT), **01** (REPEAT), or **03** (SUCCESSIVE).

If CYCLE MODE **01** is used in the last schedule of a CHAINED sequence, the entire chain will be repeated if the initiation is held closed.

## 6.2.3 CHAINED – CYCLE MODE=02 (cont.)



**Figure 6-3.** CHAINED sequence

The first schedule of a CHAINED sequence can be any of the 50 possible. In CYCLE MODE **02**, a scheduled sequence is CHAINED immediately to the next schedule (numerically 23, 24, 25, etc.). When initiated (foot switch), the sequence takes place as shown in Figure 6-3. The first schedule of the CHAINED sequence is called *N*.

While schedule *N* is sequencing, the times and parameters will be in accordance with those stored in schedule *N*. When schedule *N* has finished, the sequence jumps to schedule *N*+1. Schedule *N*+1 is then performed and so on until the sequence encounters a **00**, **01**, or **03** in the CYCLE MODE function.

Within the CHAINED sequence, the control will encounter schedules programmed with the following CYCLE MODES and will react as follows:

**00 NON-REPEAT:** The sequence will end in NON-REPEAT mode. The SCHEDULE display will then return to the first initiated sequence.

**01 REPEAT:** The sequence will start over at the initiated sequence and continue as explained in CHAINED mode.

**02 CHAINED:** The SCHEDULE display will increment by one and continue as explained in CHAINED mode.



### 6.2.3 CHAINED – CYCLE MODE=02 (cont.)

**03 SUCCESSIVE:** The sequence will end as if it were in NON-REPEAT mode. The SCHEDULE display would then be incremented by one to next schedule as in SUCCESSIVE mode but not start that sequence until the next initiation. By using **03** at the end of CHAINED sequences, extremely complicated sequences can be generated. The SCHEDULE display will display the schedule number of the last schedule performed + 1.

#### **04 CONDITIONAL**

**SUCCESSIVE:** The sequence will start over at the initiated sequence.

**05 WAIT-HERE:** The sequence will wait for FS7 or FS11 initiation input.

When HOLD and OFF in the first schedule of a CHAINED sequence and SQUEEZE in the second of the CHAINED sequence are all programmed to 00 cycles, the sequence will jump directly from the end of WELD time of the first schedule to the beginning of WELD time in the following schedule, without any interval between the two WELD times (continuous weld current). This sequence allows two different weld currents to be introduced with one immediately following the other.

The schedule number displayed at the end of a CHAINED sequence depends on the EXTENDED FUNCTION SCHEDULE SELECT (**5.5**). If it was programmed in the EXTERNAL mode, the schedule number displayed will be controlled by the combination of SS1 and SS2 (see Section 2.1). If it was programmed to the INTERNAL mode, the schedule number will be the last number entered using SCHEDULE push buttons. The number displayed need not be the first number in a sequence of CHAINED schedules. For example, if schedules 01, 02, 03 and 04 are CHAINED together and we select schedule 02, after initiation the sequence would be as follows: schedule 02, 03, 04 and at the completion of schedule 04, the SCHEDULE display would read 02, and not the first schedule 01. See Section 5.4 and Section 5.4.3.

### 6.2.4 SUCCESSIVE – CYCLE MODE=03

SUCCESSIVE mode can be thought of as a CHAINED schedule being initiated one link (or step) at a time. When the first schedule of a SUCCESSIVE series is initiated, it will sequence as in NON-REPEAT. At the completion of the schedule, the SCHEDULE display will be incremented by one and the control will return to the Ready state.

For example, if the control is programmed with a SUCCESSIVE series consisting of the schedules 01, 02, and 03 (01 and 02 being programmed as SUCCESSIVE schedules and 03 being programmed as a NON-REPEAT schedule) and the SCHEDULE display is manually set to 01 and the control is initiated, the sequence of events will be as follows: the control will sequence through schedule 01 and then increment the SCHEDULE display to 02 (flashing) and wait for the next initiation. An initiation at this point would start schedule 02. After schedule 02 was completed, the SCHEDULE display would then increment to schedule 03 (flashing). After the next initiation, schedule 03 will be completed and the SCHEDULE display will again show schedule 01.

## 6.2.4 SUCCESSIVE – CYCLE MODE=03 (cont.)

When the EXTENDED FUNCTION SCHEDULE SELECT is programmed to the EXTERNAL mode, the SUCCESSIVE series will start with the externally selected schedule and will automatically return to that schedule once the series is completed (see Section 5.4.3).

The BACK-STEP function can be used to return to the previous schedule *N-1* without continuing through the rest of the SUCCESSIVE schedules. A momentary closure of the BACK-STEP (TLS1/AUX1) switch will cause the control to return the previous schedule. This can be repeated until the first schedule of a series is reached. A maintained closure (approximately 1.5 seconds) will cause the control to return the first schedule in the series. If the BACK-STEP switch is maintained after the control reaches the first schedule, an ERROR CODE **E.r.=06** will flash in the DATA display. See Section 5.4.6.

## 6.2.5 CONDITIONAL SUCCESSIVE – CYCLE MODE=04

The CONDITIONAL SUCCESSIVE mode has been implemented to complement CHAINED and SUCCESSIVE sequences with a third type that combines the benefits of both.

The control will execute the given schedule, and at the end of HOLD will maintain the schedule valves active. At this point, the control will wait in this state and indicate the state by blinking the Front Panel HOLD LED. If the control is initiated a second time, when the initiation input closes, the control will continue by selecting the next schedule and executing it as programmed.

### EXAMPLE: PART LOCATOR & CLAMP

In some cases fixturing may require a locating pin be extended to accurately locate a part before welding. The following shows how three schedules can be programmed using various CYCLE MODES to accomplish this function.

#### Step 1 – Locate

Schedule 00 is programmed to energize Valve 1 in order to actuate a part locator. Initially, the valve is active for 60 cycles, 40 cycles of SQUEEZE and 20 cycles of HOLD (one second). At the end of this time, the control blinks the HOLD LED and waits for further input; i.e., for re-initiation.

SCHEDULE	SQUEEZE	WELD/ HEAT	PERCENT CURRENT	HOLD	OFF	IMPULSES	COOL	VALVE MODE	CYCLE MODE	SLOPE MODE	SLOPE COUNT
00	40	00	00	20	00	01	00	01	04	00	00

At this point, the operator can load a part and initiate the next sequence by opening and closing the foot switch.

#### Step 2 – Clamp

When the operator closes the foot switch again, the control activates the following CHAINED schedule immediately. During the second schedule, the control adds a second valve to the first, the clamp valve.

## 6.2.5 CONDITIONAL SUCCESSIVE – CYCLE MODE=04 (cont.)

SCHEDULE	SQUEEZE	WELD/HEAT	PERCENT CURRENT	HOLD	OFF	IMPULSES	COOL	VALVE MODE	CYCLE MODE	SLOPE MODE	SLOPE COUNT
01	40	00	00	20	00	01	00	03	02	00	00

### Step 3 – SQUEEZE & WELD

The third schedule (02), executes a SQUEEZE, WELD and HOLD using Valve 3. Valves 1 and 2 are still active (position and clamp). This sequence adds Valve 3, which closes the weld gun.

SCHEDULE	SQUEEZE	WELD/HEAT	PERCENT CURRENT	HOLD	OFF	IMPULSES	COOL	VALVE MODE	CYCLE MODE	SLOPE MODE	SLOPE COUNT
02	40	10	70	05	00	01	00	07	00	00	00

Variations in the above sequence can be accomplished using other CYCLE MODES and VALVE MODES. Since VALVE codes are in *binary* form, valve assignments are clarified in Table 6-1.

**Table 6-1. VALVE codes**

VALVE code	VALVE Indicator LEDs			Description
	VALVE3	VALVE2	VALVE1	
00	OFF	OFF	OFF	All valves off
01	OFF	OFF	ON	Valve 1 active
02	OFF	ON	OFF	Valve 2 active
03	OFF	ON	ON	Valves 1 & 2 active
04	ON	OFF	OFF	Valve 3 active
05	ON	OFF	ON	Valves 1 & 3 active
06	ON	ON	OFF	Valves 2 & 3 active
07	ON	ON	ON	Valves 1, 2 & 3 active

## 6.2.6 WAIT-HERE – CYCLE MODE=05

<b>! CAUTION !</b>
Use WAIT-HERE function (CYCLE MODE=05) with full understanding of machine and control operation. Enabling of <b>b.E.=05</b> has been added to help ensure this operation is <b>really</b> required.

This CYCLE MODE has been implemented to satisfy additional requirements for more complicated machine sequencing.

<b>NOTICE</b>
The control will allow programming of CYCLE MODE <b>05</b> <i>only</i> if EXTENDED FUNCTION parameter BEAT mode is already programmed to <b>b.E.=05</b> .

If a schedule is programmed with CYCLE MODE **05** and, if initiated by FS3 initiation, the control will execute the schedule sequence, wait either in SQUEEZE or WELD/COOL or HOLD part of the sequence, depending on programmed data in the given schedule, and maintain the schedule valves active indefinitely. At this point, the WAIT-HERE part of the sequence can be stopped by activating Emergency Stop or Temperature Limit Switch input, or it can be continued with FS7 or FS11 initiation. When the FS7 or FS11 initiation input closes, the control will continue by selecting schedule 10 or 20, respectively, and executing it as programmed whether it is a SPOT or REPEAT or CHAINED sequence.

## 6.2.6 WAIT-HERE – CYCLE MODE=05 (cont.)

In order to determine where control will wait in CYCLE MODE **05**, corresponding SCHEDULE parameter must be programmed to 99. The control will wait on SQUEEZE if SQUEEZE is programmed to 99, or WELD/COOL if IMPULSES is 99, or HOLD if HOLD is 99.

The following sequence illustrates an example of how to use this CYCLE MODE.

SCHEDULE	SQUEEZE	WELD/ HEAT	PERCENT CURRENT	HOLD	OFF	IMPULSES	COOL	VALVE MODE	CYCLE MODE	SLOPE MODE	SLOPE COUNT
00	30	00	00	00	00	01	00	01	02	00	00
01	20	00	00	10	00	01	00	03	04	00	00
02	30	00	00	00	00	01	00	03	02	00	00
03	10	20	60	10	00	99	06	07	05	00	00

After welding sequence is started with FS3, the control will execute a chain on schedule 00, wait for re-initiation on schedule 01, execute chain on schedule 02 and then it will weld indefinitely on schedule 03 (because CYCLE MODE=**05** and IMPULSES=**99**). It will continue to weld until one of two conditions occur: 1) Emergency Stop or Temperature Limit Switch is open causing sequence to be stopped or 2) FS7 or FS11 is activated causing the control to jump to schedule 10 or 20, respectively, and execute whatever sequence is programmed there. In this case for schedule 03, SQUEEZE time must be less than 99 cycles, otherwise the control will wait on SQUEEZE. In order to wait on HOLD, both SQUEEZE and IMPULSES must not be programmed to 99.

<b>! CAUTION !</b>
Use WAIT-HERE function (CYCLE MODE= <b>05</b> ) with full understanding of machine and control operation. Enabling of <b>b.E.=05</b> has been added to help ensure this operation is <b>really</b> required.

## 6.3 SLOPE MODES

The EN1000/EN1001 Series Controls offer UPSLOPE and DOWNSLOPE as standard features for applications that require their use.

UPSLOPE/DOWNSLOPE function provides a means of gradually increasing or decreasing weld current. How gradual the increase or decrease occurs is determined by the SLOPE bottom current and the number of SLOPE cycles programmed in SLOPE COUNT. The number programmed into SLOPE COUNT will determine the rate at which the control will reach the programmed weld current. SLOPE COUNT is programmable from 01 to 99 (in ms at 1000 Hz).

When SLOPE MODE is used, its function is to change current gradually. The UPSLOPE mode causes current to start from a low level and increase for a predetermined number of cycles. When DOWNSLOPE is in use, the reverse is true. Current will start to decrease to low level for a predetermined number of cycles.

The number of SLOPE cycles is automatically added to the number of WELD cycles. If 14 cycles of UPSLOPE are programmed in SLOPE COUNT, for SLOPE MODE **01** or **02**, and the number of WELD cycles is 21, the total amount of WELD time is 35 cycles.

## 6.3 SLOPE MODES (cont.)

The ENTRON UPSLOPE and DOWNSLOPE functions are sequential. The UPSLOPE COUNT and DOWNSLOPE COUNT setting and the WELD count times are independent of each other. Adjusting either of the SLOPE COUNTS or WELD count does not affect the setting or operation of the other switch setting. No arithmetic is involved in setting the SLOPE COUNT.

### 6.3.1 NO SLOPE – SLOPE MODE=00

When **00** is programmed, SLOPE is disabled. The output of the welding transformer may look like a natural UPSLOPE waveform. The welding transformer secondary load characteristics will affect the rate at which this natural UPSLOPE occurs.

### 6.3.2 UPSLOPE – SLOPE MODE=01

When **01** is selected and the control initiated, UPSLOPE will occur before WELD. If the control sequence is REPEAT mode or PULSATION mode, the UPSLOPE will only occur before the first weld impulse. If in INTERMITTENT or CONTINUOUS SEAM mode, UPSLOPE will only occur when first initiated.

When a single schedule is used to program UPSLOPE and WELD as a part of weld sequence (schedule 10 in example below), starting current by default is equal to one quarter of PERCENT CURRENT. In this example, starting current is:  $60\%/4 = 15\%$ ; and PERCENT CURRENT increment is:  $(60\% - 15\%)/09 = 5\%$ .

SCHEDULE	SQUEEZE	WELD/ HEAT	PERCENT CURRENT	HOLD	OFF	IMPULSES	COOL	VALVE MODE	CYCLE MODE	SLOPE MODE	SLOPE COUNT
10	10	26	60	20	00	01	00	01	00	01	09

Schedules 11 and 12 are used to show how two CHAINED schedules can be used to program UPSLOPE and WELD parts of the weld sequence with any other values for starting PERCENT CURRENT. In this example, starting current is 30%; and PERCENT CURRENT increment is:  $(75\% - 30\%)/15 = 3\%$ .

SCHEDULE	SQUEEZE	WELD/ HEAT	PERCENT CURRENT	HOLD	OFF	IMPULSES	COOL	VALVE MODE	CYCLE MODE	SLOPE MODE	SLOPE COUNT
11	10	00	30	00	00	01	00	01	02	01	15
12	00	20	75	20	00	01	00	01	00	00	00

### 6.3.3 DOWNSLOPE – SLOPE MODE=02

When **02** is selected and the control initiated, DOWNSLOPE will occur after WELD. If the control is in REPEAT mode or PULSATION mode, DOWNSLOPE will only occur after the last weld impulse. For example, if the schedule has programmed 10 cycles of DOWNSLOPE and 25 cycles of WELD, DOWNSLOPE will start after WELD. The complete WELD and DOWNSLOPE time would add to 35 cycles. If in INTERMITTENT or CONTINUOUS SEAM mode, DOWNSLOPE will only occur when the last initiation, with a programmed DOWNSLOPE, is removed.

### 6.3.3 DOWNSLOPE – SLOPE MODE=02 (cont.)

Schedule 20 is used to show how DOWNSLOPE and WELD parts of the sequence are programmed in a single schedule. The bottom current by default is equal to one quarter of PERCENT CURRENT. In this example, starting current is 80%; bottom current is:  $80\%/4 = 20\%$ ; and PERCENT CURRENT increment is:  $(80\% - 20\%)/10 = 6\%$ .

SCHEDULE	SQUEEZE	WELD/HEAT	PERCENT CURRENT	HOLD	OFF	IMPULSES	COOL	VALVE MODE	CYCLE MODE	SLOPE MODE	SLOPE COUNT
20	10	25	80	20	00	01	00	01	00	02	10

Schedules 21 and 22 are used to show how two CHAINED schedules can be used to program WELD and DOWNSLOPE parts of the weld sequence with any desired values for bottom current of last DOWNSLOPE pulse. The bottom current is 10%, and PERCENT CURRENT increment is:  $(75\% - 15\%)/15 = 4\%$ .

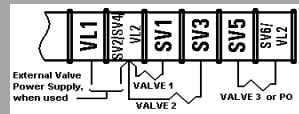
SCHEDULE	SQUEEZE	WELD/HEAT	PERCENT CURRENT	HOLD	OFF	IMPULSES	COOL	VALVE MODE	CYCLE MODE	SLOPE MODE	SLOPE COUNT
21	10	20	75	00	00	01	00	01	02	02	15
22	00	00	15	20	00	01	00	01	00	00	00

## 6.4 VALVE MODES

Each programmed schedule can have any one of the three valve outputs (or none) enabled during its schedule. The three solenoid valves are activated based on the VALVE MODE programmed as shown in Table 6-2.

**Table 6-2. VALVE MODES and Valve Outputs**

VALVE MODE (binary)	VALVE LEDs: 3, 2, 1	Valve Outputs		
		TS1-SV5	TS1-SV3	TS1-SV1
00	0 0 0			
01	0 0 1			X
02	0 1 0		X	
03	0 1 1		X	X
04	1 0 0	X		
05	1 0 1	X		X
06	1 1 0	X	X	
07	1 1 1	X	X	X



When in PROGRAM mode and selection of VALVE MODE is being made, the VALVE indicator LEDs will indicate the selected valve(s). The valve output(s) will not be energized while in PROGRAM mode.

### NOTICE

The VALVE MODES indicated within the valve selection chart may differ with the use of PROCESS OUTPUTS. Refer to Section 5.4.7 of this manual for further information on the use of Valve 3 as a PROCESS OUTPUT indicator.

## 7.0 STEPPER ON EN1000/EN1001 SERIES CONTROLS

Up to **five** steppers may be programmed on the EN1000 or EN1001 Series Controls with PROM firmware version 619016-001**R** or later.

The weld stepper may be used to compensate the gradual deformation of a welding machine's electrodes. This deformation occurs because of the repeated application of heat and pressure to the relatively soft electrode material, resulting in a broadening of the electrode face (mushrooming) with continued usage. The increasing face diameter results in a decreasing current density, which eventually reaches a point where satisfactory welds can no longer be made. At this time, the weld current setting must be adjusted upwards or the electrodes must be re-dressed before further use.

The weld stepper increases the number of satisfactory welds that can be made without re-dressing the electrodes, by increasing the welding current in steps as the mushrooming progresses. This action maintains the current density fairly constant for a relatively large number of welds. The stepper can be programmed to not only change the weld current, but also the weld time, and even the complete welding schedule if desired.

Each of the steppers may have up to maximum of ten steps, and each step may be programmed from 0000 to 9999 welds.

The stepper can also be programmed to provide an electrical output after the **LAST STEP** to sound an alarm to alert the operator that the electrodes need to be re-dressed or replaced. After end of **LAST STEP**, stepper can be reset manually or automatically.

The stepper may be useful when welding complex multiple spot sequences. On a large welded assembly for example, several welds may require a given time and current setting and then several more welds may require a different time and current setting, continuing in this manner through several changes in welding parameters.

Each of the steppers may also be used as simple weld count down-counter.

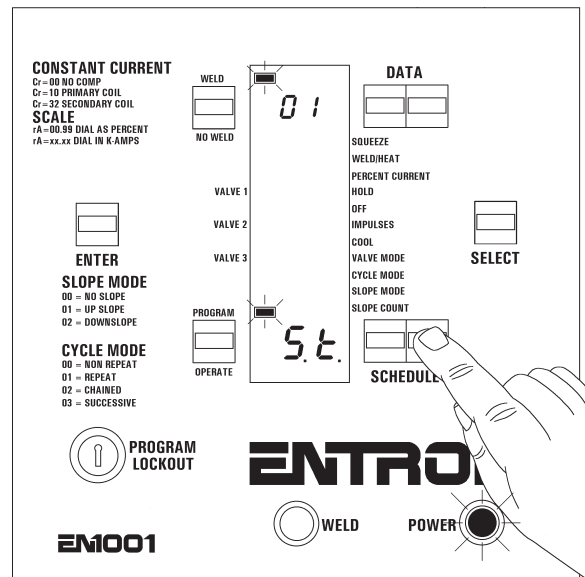


Figure 7-1. STEPPER enabling

### NOTICE

In PROM firmware version 619016-002**P**, a new STEPPER mode was added – **S.t.=02**, for single stepper counter with multiple steps and any possible schedule sequence combination.

Stepper counter will be decremented during welding sequence only if weld was made; i.e., WELD time and weld CURRENT must be programmed, and control must be in the WELD mode (External Weld/No Weld Switch, if used, must be closed and Front Panel WELD/NO WELD indicator LED must be in WELD mode).

## 7.1 SCHEDULE MAP

Since up to ten steps may be programmed per stepper in STEPPER mode **01**, ten schedules are assigned for each stepper, as illustrated in Table 7-1.

**Table 7-1.** Schedule map used for STEPPER programming

STEPPER	SCHEDULES	WELD STEPS		LAST STEP	LAST COUNT	INITIATION
		STEP	COUNT			
<b>A</b>	00	<i>a.0</i>	0000 to 9999	<b>L.S.</b> 00 to 09	<b>L.C.</b> 0000 to 9999	FS3
	01	<i>a.1</i>				
	02	<i>a.2</i>				
	03	<i>a.3</i>				
	04	<i>a.4</i>				
	05	<i>a.5</i>				
	06	<i>a.6</i>				
	07	<i>a.7</i>				
	08	<i>a.8</i>				
	09	<i>a.9</i>				
<b>B</b>	10	<i>b.0</i>	0000 to 9999	<b>L.S.</b> 10 to 19	<b>L.C.</b> 0000 to 9999	FS3 or FS7
	11	<i>b.1</i>				
	12	<i>b.2</i>				
	13	<i>b.3</i>				
	14	<i>b.4</i>				
	15	<i>b.5</i>				
	16	<i>b.6</i>				
	17	<i>b.7</i>				
	18	<i>b.8</i>				
	19	<i>b.9</i>				
<b>C</b>	20	<i>c.0</i>	0000 to 9999	<b>L.S.</b> 20 to 29	<b>L.C.</b> 0000 to 9999	FS3 or FS11
	21	<i>c.1</i>				
	22	<i>c.2</i>				
	23	<i>c.3</i>				
	24	<i>c.4</i>				
	25	<i>c.5</i>				
	26	<i>c.6</i>				
	27	<i>c.7</i>				
	28	<i>c.8</i>				
	29	<i>c.9</i>				
<b>D</b>	30	<i>d.0</i>	0000 to 9999	<b>L.S.</b> 30 to 39	<b>L.C.</b> 0000 to 9999	FS3
	31	<i>d.1</i>				
	32	<i>d.2</i>				
	33	<i>d.3</i>				
	34	<i>d.4</i>				
	35	<i>d.5</i>				
	36	<i>d.6</i>				
	37	<i>d.7</i>				
	38	<i>d.8</i>				
	39	<i>d.9</i>				
<b>E</b>	40	<i>e.0</i>	0000 to 9999	<b>L.S.</b> 40 to 49	<b>L.C.</b> 0000 to 9999	FS3
	41	<i>e.1</i>				
	42	<i>e.2</i>				
	43	<i>e.3</i>				
	44	<i>e.4</i>				
	45	<i>e.5</i>				
	46	<i>e.6</i>				
	47	<i>e.7</i>				
	48	<i>e.8</i>				
	49	<i>e.9</i>				

For STEPPER mode **02**, the same schedule map is used as in mode **01**, except that only **one** stepper counter exists with all schedules from 00 to 49, with maximum of 50 steps.



## 7.2 STEPPER PROGRAMMING

### 7.2.1 EXTENDED FUNCTION PROGRAMMING

STEPPER ENABLE (**5.t.**) EXTENDED FUNCTION parameter is used to **enable** STEPPER.

1. Click the SELECT push button until SLOPE COUNT is reached, then click once more.
2. Press the SCHEDULE push buttons to find **5.t.** in the SCHEDULE display.
3. Program the required values according to the following table.
4. Press ENTER push button.

See Section 7.2.5 for quick setup instructions.

**Table 7-2.** *STEPPER codes*

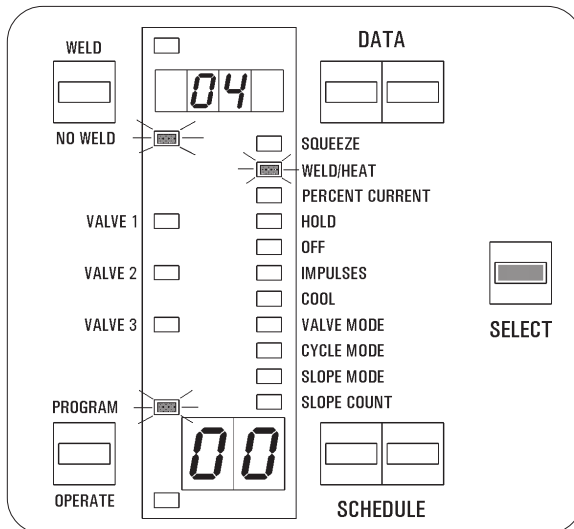
5.t.	STEPPER	Description
00	disable	STEPPER operation is disabled
01	enable	Multiple steppers with maximum 10 steps per stepper
02	enable	Single stepper counter with multiple steps

### 7.2.2 WELD SEQUENCE PROGRAMMING

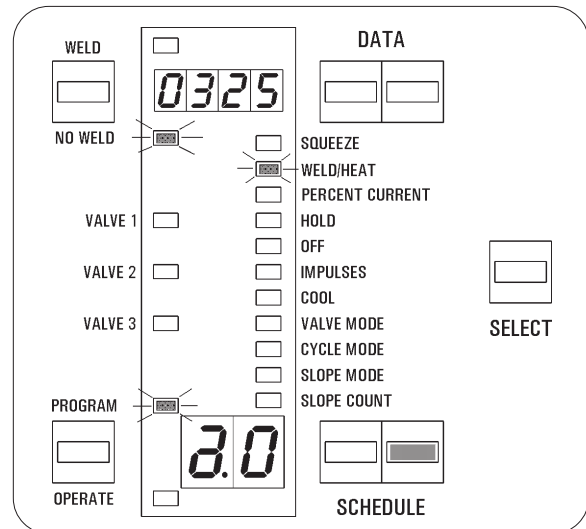
1. Put the control in PROGRAM mode by clicking PROGRAM/OPERATE push button.
2. Using standard programming procedure, program all weld sequence parameters for first schedule for desired stepper.
3. Using *copy schedule* Front Panel shortcuts (i.e., press ENTER and right SCHEDULE push button in PROGRAM mode), copy current schedule to the next one and repeat as many times as number of steps needed for that stepper.
4. PERCENT CURRENT or WELD/HEAT must be adjusted in each step after the first one.
5. Put the control in OPERATE mode by clicking PROGRAM/OPERATE push button.

### 7.2.3 STEP COUNTS PROGRAMMING

1. Using the SCHEDULE push buttons, set the **first** schedule for desired stepper; e.g., for stepper **A**, first schedule is **00**.
2. Put the control in PROGRAM mode by clicking PROGRAM/OPERATE push button.



**Figure 7-2.** *Select WELD/HEAT*



**Figure 7-3.** *Program WELD COUNT*

### 7.2.3 STEP COUNTS PROGRAMMING (cont.)

3. Click the SELECT push button until WELD/HEAT parameter is reached (Figure 7-2).
4. Program the required WELD time for the weld sequence; e.g., **04** cycles.
5. Press the SCHEDULE push buttons to find **2.0** in the SCHEDULE display (Figure 7-3).
6. Program the required WELD COUNT for this step; e.g., **0325** welds.
7. Click SELECT push button to find PERCENT CURRENT and program the required CURRENT in [%] or [kA] for this step of the weld sequence.
8. Put the control in OPERATE mode by clicking PROGRAM/OPERATE push button.
9. For programming all other steps from **2.1** to **2.9**, increase the schedule number and repeat Steps 2 through 8.

### 7.2.4 LAST STEP AND LAST COUNT PROGRAMMING

1. Dial any schedule from schedule map for desired stepper. For example, for STEPPER mode **01** and stepper **A**, any schedule from **00** to **09**; for stepper **B**, any schedule from **10** to **19**; etc. For STEPPER mode **02**, dial any schedule.
2. Put the control in PROGRAM mode.
3. Press the SCHEDULE push buttons to find **L.5.** in the SCHEDULE display, as shown in Figure 7-4.
4. Program the desired LAST STEP for this stepper; e.g., for stepper **A**, LAST STEP in STEPPER mode **01** may be any number from **00** to **09** (see Figure 7-4); but in STEPPER mode **02**, it may be any schedule number from **00** to **49**. In fact, this value will be first step at beginning of the weld sequence. This value will be reset or reprogrammed after resetting the stepper.
5. Press the SCHEDULE push buttons to find **L.C.** in the SCHEDULE display, as shown in Figure 7-5.
6. Program the desired LAST COUNT for this stepper; e.g., for stepper **A**, LAST COUNT may be any number from **0000** to **9999**, as shown in Figure 7-5. In fact, this value will be first count at beginning of the weld sequence. This value will be reset or reprogrammed after resetting the stepper.
7. Put the control back in OPERATE mode.

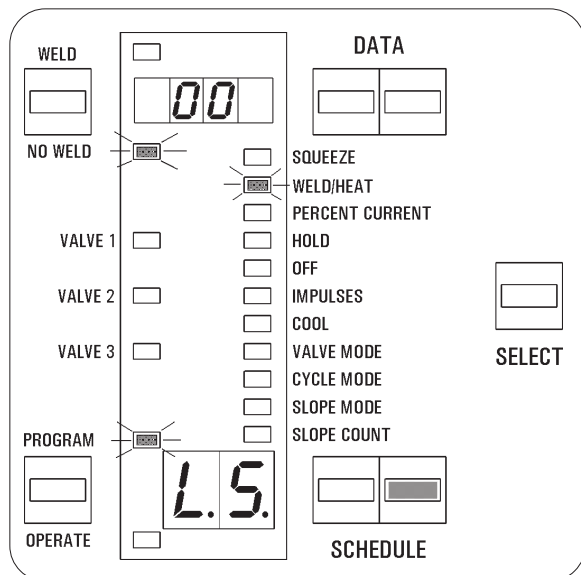


Figure 7-4. Program LAST STEP

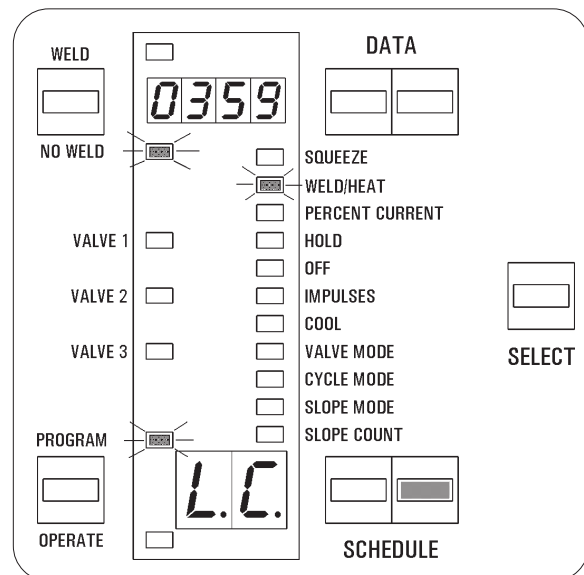


Figure 7-5. Program LAST COUNT

## 7.2.5 QUICK SETUP INSTRUCTIONS FOR STEPPER

For basic single schedule welding where weld time and/or percent current will need to increase after a given quantity of welds, follow these steps:

1. Put control in **PROGRAM** mode.
2. In EXTENDED FUNCTIONS (**EF**), set **S.t.** = **01**.
3. Select desired starting schedule (00, 10, 20, 30, or 40).
4. Program all SCHEDULE parameters – SQUEEZE, WELD/HEAT, PERCENT CURRENT, HOLD, etc.
5. Press SELECT push button, moving indicator LED to WELD/HEAT parameter.
6. Select first weld step for schedule by pressing SCHEDULE push buttons until desired weld step is displayed:
  - If using schedule 00, select weld step **3.0**
  - If using schedule 10, select weld step **6.0**
  - If using schedule 20, select weld step **9.0**
  - If using schedule 30, select weld step **1.0**
  - If using schedule 40, select weld step **4.0**
7. Program required WELD COUNT for this step as follows:
  - Press and hold** left DATA push button to enter 1000s digit.
  - Press and release quickly** left DATA push button to enter 100s digit.
  - Press and hold** right DATA push button to enter 10s digit.
  - Press and release quickly** right DATA push button to enter 1s digit.Press ENTER when done and then press SELECT push button.
8. Copy this schedule by pressing and holding ENTER and right SCHEDULE push button. Repeat copying of this schedule for as many steps needed for that stepper.
9. Change each schedule's WELD/HEAT and/or PERCENT CURRENT as required.
10. Return to starting schedule (00, 10, 20 30 or 40). Reset stepper by pressing and holding ENTER and pressing both DATA push buttons simultaneously.
11. Put control in **OPERATE** mode and begin welding.
12. Return to the first starting schedule.

After all weld steps are complete, control will stop and display **S.t. E.n.d.**

### NOTICE

When using **S.t.=02** with multiple steppers, **all steppers must be reset.**

To reset stepper, repeat steps 10 and 11. Control must be in **PROGRAM** mode for step 10.

## 7.3 SEQUENCE (SCHEDULE) INITIATION IN STEPPER MODE

### 7.3.1 SCHEDULE SELECT OPTIONS FOR STEPPER MODE 5.t.=01

Since the stepper requires certain specific starting schedules, the SCHEDULE SELECT (5.5.) options with STEPPER mode 01 are described in the following sections.

#### INTERNAL SCHEDULE SELECT – 5.5.=00

As shown in Table 7-1, each of the five steppers can be initiated with the FS3 initiation switch. This is possible only if any of the ten possible schedules for desired stepper is dialed on the SCHEDULE display.

Besides FS3 initiation, steppers B and C can be initiated with FS7 and FS11 initiation switches. FS7 is dedicated to initiate only stepper B (schedule 10 to 19) regardless of what schedule is dialed on SCHEDULE display. FS11 is dedicated to initiate only stepper C (schedule 20 to 29) regardless of what schedule is dialed on SCHEDULE display.

#### EXTERNAL SCHEDULE SELECT – 5.5.=01

In this mode, only four steppers can be initiated with the FS3 initiation switch. This is possible only if FS7 and FS11 are used for stepper selection, as shown in Table 7-3.

**Table 7-3.** Stepper selection using FS7 and FS11

STEPPER	SCHEDULE	TS1-FS7/SS1	TS1-FS11/SS3	INITIATION
A	00	OPEN	OPEN	TS1-FS3
B	10	CLOSED	OPEN	TS1-FS3
C	20	OPEN	CLOSED	TS1-FS3
D	30	CLOSED	CLOSED	TS1-FS3

#### ANTI-TIE DOWN – 5.5.=02

In this mode, any stepper can be initiated with both FS7 and FS11 initiation switches. The STEPPER operation is the same as with standard FS3 initiation.

#### EXTERNAL BINARY SELECT WITH S49 OPTION – 5.5.=03

In this mode, any of five steppers can be initiated with FS3 initiation switch. The stepper selection is possible with closing one of the SS1, SS2, SS4, or SS8.

**Table 7-4.** Stepper selection using SS1, SS2, SS4, SS8

STEPPER	SCHEDULE	SS1	SS2	SS4	SS8	INITIATION
A	00	0	0	0	0	TS1-FS3
B	10	1	0	0	0	TS1-FS3
C	20	0	1	0	0	TS1-FS3
D	30	0	0	1	0	TS1-FS3
E	40	0	0	0	1	TS1-FS3

### 7.3.2 SCHEDULE SELECT OPTIONS FOR STEPPER MODE 5.t.=02

#### NOTICE

Stepper counter will be decremented *only* if FS3 (or both FS7 and FS11 in ANTI-TIE DOWN mode) is used for initiation.

When either FS7 or FS11 is used for initiation in STEPPER mode 02, stepper counter will not be decremented, and control will execute the welding sequence starting with schedule 10 or 20, respectively. But, when S49 Option is used for EXTERNAL BINARY SELECT (5.5.=03) after FS7 initiation, the control will execute any selected schedule, instead of schedule 10.

## 7.4 STEPPER OPERATION

### 7.4.1 OPERATION ALGORITHM FOR STEPPER MODE $S.E.=01$

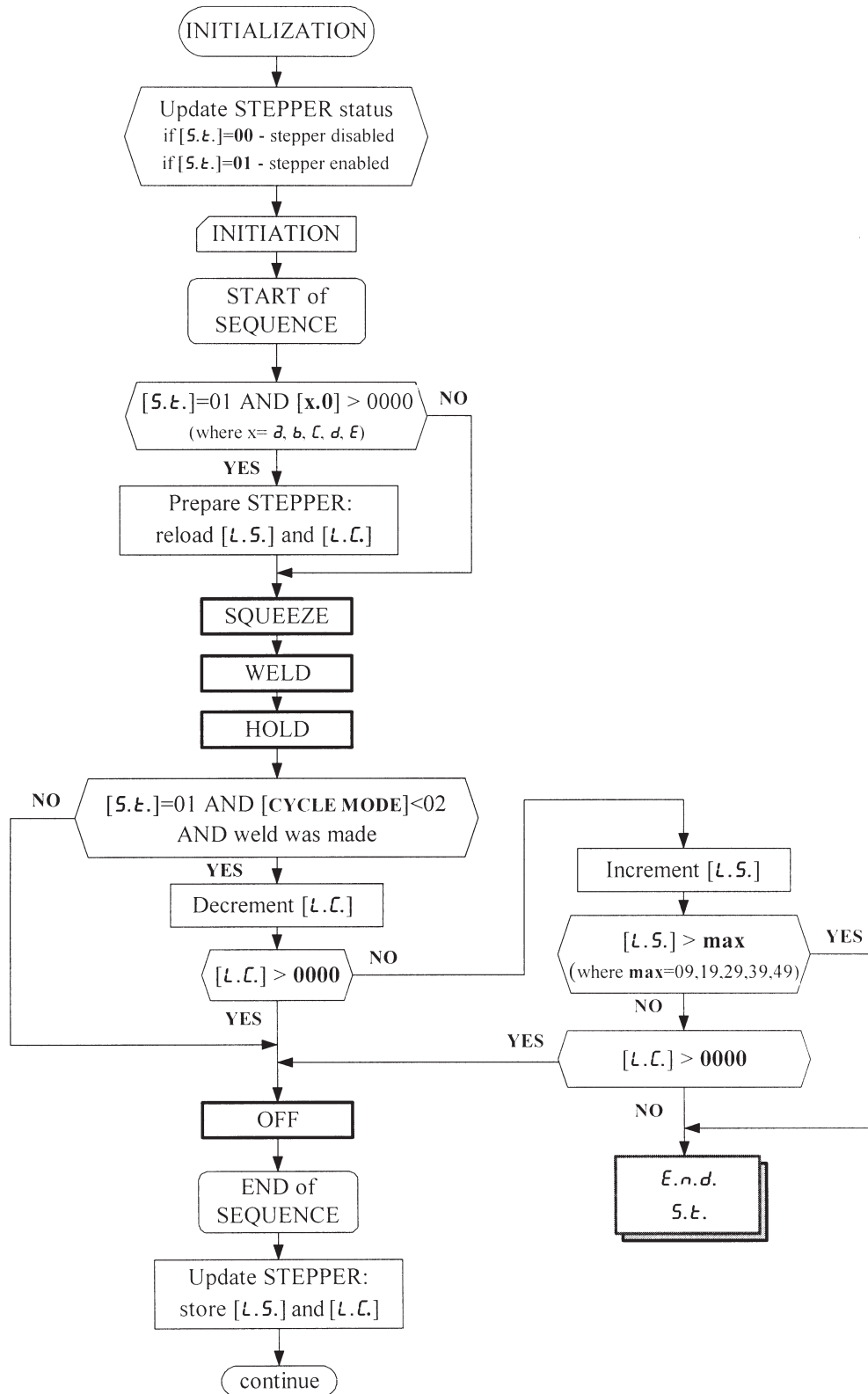


Figure 7-6. Algorithm

## 7.4.2 STEPPER OPERATION FOR STEPPER MODE *S.t.=02*

In this mode, the maximum number of steps is 50, which is possible only if a single schedule is used per step. If more CHAINED schedules are required in a welding sequence, the number of steps is determined by the number of CHAINED schedules used in each step.

The algorithm is almost identical to the one used for STEPPER mode *01* (see Figure 7-6), except that only **one** stepper counter is used and when the LAST STEP is incremented, the control will check if that number is greater than the maximum number of schedules, 49 in this case, and then show END OF STEPPER message, if necessary. Also, stepper counter will be decremented only if FS3 (or both FS7 and FS11 in ANTI-TIE DOWN mode) is used for initiation.

The following table demonstrates this mode with five CHAINED schedules per step or welding sequence. WELD COUNT **must** be programmed in the first schedule of the CHAINED sequence. Following the LAST STEP, the next schedule should be empty, in this example schedule 17. If WELD COUNT in that schedule is 0000 that will indicate END OF STEPPER – *S.t.=E.o.d.*

**Table 7-5. Programming for STEPPER mode *02***

SCHEDULE	SQUEEZE	WELD/ HEAT	WELD STEPS STEP COUNT	PERCENT CURRENT	HOLD	OFF	IMPULSES	COOL	VALVE MODE	CYCLE MODE	SLOPE MODE	SLOPE COUNT
<i>first</i> step: LAST STEP is <b>L.S.=00</b> and LAST COUNT <b>L.C.</b> will be from <b>0325</b> to <b>0000</b>												
00	40	00	<b>a.0</b> 0325	00	20	00	01	00	01	02	00	00
01	10	25	<b>a.1</b> xxxx	60	10	00	01	00	03	04	00	00
02	10	00	<b>a.2</b> xxxx	00	00	00	01	00	01	02	00	00
03	30	20	<b>a.3</b> xxxx	50	10	00	01	00	03	03	00	00
04	10	00	<b>a.4</b> xxxx	00	00	00	01	00	07	00	00	00
<i>second</i> step: LAST STEP is <b>L.S.=05</b> and LAST COUNT <b>L.C.</b> will be from <b>0250</b> to <b>0000</b>												
05	40	00	<b>a.5</b> 0250	00	20	00	01	00	01	02	00	00
06	10	25	<b>a.6</b> xxxx	65	10	00	01	00	03	04	00	00
07	10	00	<b>a.7</b> xxxx	00	00	00	01	00	01	02	00	00
08	30	20	<b>a.8</b> xxxx	55	10	00	01	00	03	03	00	00
09	10	00	<b>a.9</b> xxxx	00	00	00	01	00	07	00	00	00
<i>third</i> step: LAST STEP is <b>L.S.=10</b> and LAST COUNT <b>L.C.</b> will be from <b>0195</b> to <b>0000</b>												
10	40	00	<b>b.0</b> 0195	00	20	00	01	00	01	02	00	00
11	10	25	<b>b.1</b> xxxx	70	10	00	01	00	03	04	00	00
12	10	00	<b>b.2</b> xxxx	00	00	00	01	00	01	02	00	00
13	30	20	<b>b.3</b> xxxx	60	10	00	01	00	03	03	00	00
14	10	00	<b>b.4</b> xxxx	00	00	00	01	00	07	00	00	00
<i>fourth</i> step: LAST STEP is <b>L.S.=15</b> and LAST COUNT <b>L.C.</b> will be from <b>0150</b> to <b>0000</b>												
15	30	20	<b>b.5</b> 0150	75	10	20	01	00	03	01	00	00
<i>fifth</i> step: LAST STEP is <b>L.S.=16</b> and LAST COUNT <b>L.C.</b> will be from <b>0001</b> to <b>0000</b>												
16	30	00	<b>b.6</b> 0001	00	00	00	01	00	04	00	00	00
17	00	00	<b>b.7</b> 0000	00	00	00	01	00	00	00	00	00

### NOTICE

If STEPPER RESET is performed by holding ENTER and pressing both DATA push buttons at the same time, the LAST STEP will be **L.S.=00** in this example, and LAST COUNT **L.C.=0325**, no matter which schedule is dialed on Front Panel display.

## 7.5 STEPPER RESET

### 7.5.1 MANUAL STEPPER RESET

1. Dial any schedule from schedule map for desired stepper. For example, in STEPPER mode **01** for stepper **A**, dial any schedule from **00** to **09**; in STEPPER mode **02**, dial any schedule.
2. Put the control in PROGRAM mode.
3. Press and hold the ENTER push button. While holding the ENTER push button, press both DATA push buttons at the same time and hold momentarily. After this, LAST STEP **L.S.** and LAST COUNT **L.C.** parameters will be initialized with appropriate values programmed for first step; e.g., for stepper **A**, LAST STEP will now be **L.S.=00**, and LAST COUNT **L.C.=0325**. The stepper will be reset only if all three push buttons are properly pressed. After reset, both initialized parameters will be displayed on the SCHEDULE and DATA displays for a short period of time. These two parameters may be reprogrammed by entering desired values and pressing ENTER, at any time, without resetting stepper using all three push buttons.
4. Put the control back in OPERATE mode.

#### NOTICE

STEPPER RESET may be performed not only by holding ENTER and pressing both DATA push buttons at the same time, but also by manual programming of LAST STEP **L.S.** and LAST COUNT **L.C.** for corresponding stepper.

### 7.5.2 AUTOMATIC STEPPER RESET

When necessary, the stepper can be automatically reset by adding the RESET command using an additional schedule after LAST STEP. The RESET command is simply an empty schedule – no valves, no other parameters except for OFF time. If the stepper counter reaches zero on LAST STEP, the control will read the next schedule. If it finds the RESET command, it will reload the stepper automatically. Any new sequence will start again on the first step.

To enable automatic STEPPER RESET:

1. Display the next schedule after the last schedule from schedule map for desired stepper.
2. Put the control in PROGRAM mode.
3. Clear all parameters for that schedule. In PROGRAM mode, the *delete* shortcut may be used by holding ENTER and pressing the PROGRAM/OPERATE push button.
4. Make sure that the WELD COUNT is 0000 for this step.
5. Program the OFF time to 99 cycles.
6. Put the control back in OPERATE mode.

If necessary, a warning signal may be added just before the RESET command. Simply add an additional step with a very low WELD COUNT (for example 0010 welds). This schedule may contain an additional valve output which may be used to warn the operator by means of light or some other alarm device.

SCHEDULE	...	WELD STEPS		...	OFF	...	VALVE MODE	DESCRIPTION
		STEP	COUNT					
00		<b>2.0</b>	0325				01	Step 1
01		<b>2.1</b>	0400				01	Step 2
02		<b>2.2</b>	0450				01	Step 3
03		<b>2.3</b>	0010				03	Pre-warning step, adding Valve 2 output
04		<b>2.4</b>	0000		99		00	RESET command (all other parameters= <b>00</b> )

### 7.5.3 STEPPER RESET USING EXTERNAL SWITCH INPUT

Since PROM firmware version 619016-002S, it is possible to use an External Reset switch (normally closed) connected between TS1-ES1 and TS1-GND to cause STEPPER RESET. To enable EXTERNAL RESET, EXTENDED FUNCTION **b.E.** must be programmed to **06**. Whenever momentary switch is activated (open), control will automatically reset active stepper.

### 7.6 USING THE STEPPER AS A COUNTER

The stepper counter may be used as a down-counter. It is simply necessary to load a schedule stepper counter with a value to count down from. The maximum allowable value is 9999. This function may be used in a single weld schedule, such as 00, 10, 20, 30, or 40, or any welding sequence starting with those schedules.

1. Select schedule to be used.
2. Put the control in PROGRAM mode.
3. Enable STEPPER by programming **S.t.=01** or **02**.
4. Program weld schedule as required.
5. Select WELD/HEAT parameter again.
6. Find **d.0**, **b.0**, etc., by pressing the right SCHEDULE push button.
7. Program desired COUNT from **0000** to **9999** in the DATA display and press ENTER.
8. Reset STEPPER by pushing ENTER and the two DATA push buttons simultaneously.
9. Put the control back in OPERATE mode.

#### NOTICE

If necessary, the message **S.t. E.n.d.** may be shown at the end of the countdown. Select the next schedule and clear it by using the *clear data* shortcut (see Section 5.4.5). Program a WELD time of 01 cycles and return to the OPERATE mode.

### 7.7 DISPLAYING THE STEPPER COUNT DURING OPERATION

The stepper count may be displayed during operation if necessary. Since this is not a principal WELD function, the access to the display requires the following:

1. Select the schedule to be used.
2. Put the control in PROGRAM mode.
3. Select the WELD/HEAT parameter.
4. Find **L.C.** by pressing the right SCHEDULE push button.
5. Put the control back in OPERATE mode.

The LAST COUNT will be shown after end of each welding sequence.

### 7.8 END OF STEPPER

When LAST STEP is reached, control will flash message **S.t. E.n.d.** on displays. This message can be cleared by pressing any Front Panel push button or by activating Emergency Stop.

To avoid resetting the counter value, use the External Switch input (see Section 7.5.3).

If **P.O.** is programmed to **10** or **17**, PROCESS OUTPUT valve or Valve 3 will be active as long as message **S.t. E.n.d.** is flashing on displays.



## 8.0 CONSTANT CURRENT OPERATION (EN1001 *only*)

SECONDARY PRESET-RANGE COMPENSATION or MONITORING	Section 8.2.1
PRIMARY PRESET-RANGE COMPENSATION or MONITORING	Section 8.2.2
SECONDARY AUTO-RANGE COMPENSATION or MONITORING	Section 8.2.3
PRIMARY AUTO-RANGE COMPENSATION or MONITORING	Section 8.2.4

To operate the control with CONSTANT CURRENT, it is necessary to be familiar with the operation of the control in NON-CONSTANT CURRENT mode.

The function of the Current Compensation feature of the EN1001 Series Controls is that of maintaining the welding current constant at the preset level, despite influencing factors which could otherwise make the current vary. With the Current Compensation feature in operation, the current remains substantially constant regardless of line voltage variations, changes in machine power factor caused by movement of ferrous metal within the secondary, changes in the size or shape of the secondary, changes in material resistance, or any combination of these factors.

To operate the EN1001 Control in CURRENT COMPENSATION modes, the following steps are necessary:

1. Set up sensor selection jumper according to selected Current Sensor (see Section 8.1).
2. Software parameter setup:
  - COMPENSATION parameters (see Section 8.2)
  - Transformer's TURNS RATIO (**t.r.**)
  - CONSTANT CURRENT mode (**C.r.**)
  - RANGE (**r.A.**)
  - PROCESS OUTPUT parameter (**P.O.**) (see Section 8.3)
3. Program the weld schedules.

Step 1 and Step 2 are needed when control is initially installed or a new control mode is selected.

When using the EN1001 Control in CONSTANT CURRENT mode, both AUTOMATIC POWER FACTOR and CONSTANT CURRENT function will compensate current. When the control operates under poor power factor and low PERCENT CURRENT output situation, the MANUAL POWER FACTOR should be set to 99% (**P.P.=99**) to obtain better performance (see Section 5.4.10).

The Current Compensation feature **should not be expected to correct for electrode wear, improper electrode size or force**, or other problems caused by improper machine setup and maintenance.

## 8.1 HARDWARE SETUP

The EN1001 Control can be operated with the following types of Current Sensors:

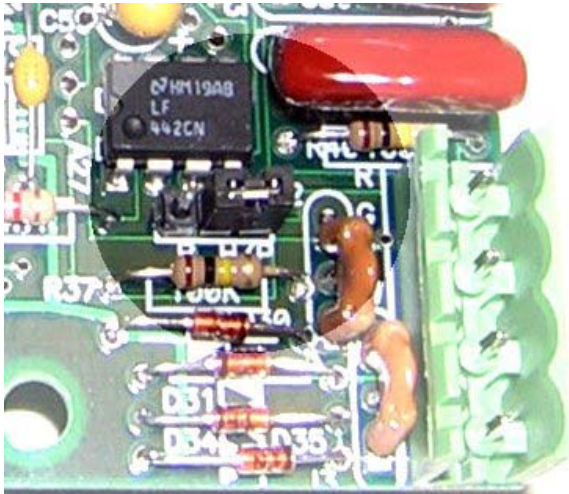
1. Primary Current Transformer
2. Secondary Rogowski Coil

## 8.1 HARDWARE SETUP (cont.)

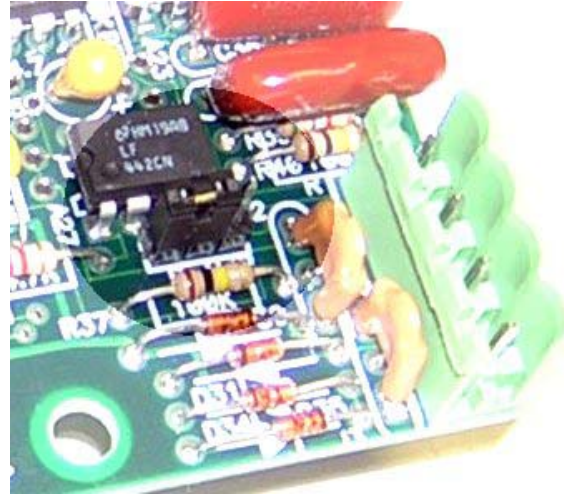
To obtain the proper signal, the sensor selection jumper must be set on the correct position dependent on type of Current Sensor used:

1. If the control is connected with a Primary Current Transformer, the sensor selection jumper should be put on the two pins on the right, as shown in Figure 8-1.
2. If the control is connected with a Secondary Rogowski Coil, the sensor selection jumper should be put on the two pins on the left, as shown in Figure 8-2.

This hardware setup must be done when the control is initially installed, when a new different type of Current Sensor is connected with the control or control board is exchanged.



**Figure 8-1.** Jumper setting:  
Primary Current Transformer  
(two pins on the right)



**Figure 8-2.** Jumper setting:  
Secondary Rogowski Coil  
(two pins on the left)

## 8.2 SOFTWARE PARAMETERS SETUP

The following working modes have been defined for the EN1001 Control:

1. SECONDARY PRESET-RANGE COMPENSATION or MONITORING mode with Rogowski Coil – **C.r.=32** or **33**
2. PRIMARY PRESET-RANGE COMPENSATION or MONITORING mode with Current Transformer – **C.r.=12** through **19**
3. SECONDARY AUTO-RANGE COMPENSATION or MONITORING mode with Rogowski Coil – **C.r.=30** or **31**
4. PRIMARY AUTO-RANGE COMPENSATION or MONITORING mode with Current Transformer – **C.r.=10** or **11**

These working modes are used to inform the control which Current Sensor has been connected and which current setting will be used to input data. The control will then automatically adjust the gain of the embedded amplifier and control the working current at the desired value.

Before CONSTANT CURRENT function is operational, the operator must inform the control which working mode is selected by setting the proper EXTENDED FUNCTION parameters **t.r.**, **C.r.**, and **r.A.** The instructions for programming **t.r.**, **C.r.**, and **r.A.** are described in Sections 5.4.14, 5.4.15 and 5.4.16.

## 8.2.1 SECONDARY PRESET-RANGE COMPENSATION OR MONITORING MODE WITH ROGOWSKI COIL

In these modes, a learning-type setup process is **not** required. However, **r.R.** must be programmed for the desired CURRENT range in which the machine will operate. Available values of **r.R.** are shown in Table 8-1. If the desired range of **r.R.** is far below or far above operating range, current overshooting or poor compensation will result.

### COMPENSATION

With **C.r.=32**, the control will operate in SECONDARY PRESET-RANGE COMPENSATION mode with Rogowski Coil. When the control operates in this COMPENSATION mode, the value of PERCENT CURRENT setting in the weld schedules should be input as the required secondary output current in [kA].

### MONITORING

With **C.r.=33**, the control will operate in SECONDARY PRESET-RANGE MONITORING mode with Rogowski Coil. When the control operates in this MONITORING mode, the control will only display the weld current after a weld but will not compensate the current error. The value of PERCENT CURRENT setting in the weld schedules should be input as the percentage [%] of maximum current output of the control.

**Table 8-1.** *Operating Ranges for Preset-Range Selection with Rogowski Coil*

Current Range in kA	RANGE Parameter <b>r.R.</b>	Current Range in kA	RANGE Parameter <b>r.R.</b>
0 to 2	02.00	0 to 30	30.00
0 to 3	03.00	0 to 40	40.00
0 to 4	04.00	0 to 50	50.00
0 to 5	05.00	0 to 60	60.00
0 to 6	06.00	0 to 70	70.00
0 to 8	08.00	0 to 80	80.00
0 to 10	10.00	0 to 90	90.00
0 to 20	20.00	0 to 100	99.99

## 8.2.2 PRIMARY PRESET-RANGE COMPENSATION OR MONITORING MODE WITH CURRENT TRANSFORMER

In these modes, a learning-type setup process is **not** required. **r.R.** should be set to the desired secondary CURRENT range, and **t.r.** should be set to the TURNS RATIO of the transformer. The maximum values of **r.R.** are limited by the maximum value of current transformer and the turns ratio of transformer, the relation is shown by the following equation:

$$\text{Maximum } r.R. = \text{Maximum Current of current sensor} \times \text{Turns Ratio of transformer}$$

### COMPENSATION

With **C.r.= 12, 14, 16** or **18** if using PT2, PT5, PT10 or PT20 as Current Sensor, the control will operate in PRIMARY PRESET-RANGE COMPENSATION mode. When the control operates in this COMPENSATION mode, the value of CURRENT setting in the weld schedules should be input as the desired secondary current in [kA] value.

## 8.2.2 PRIMARY PRESET-RANGE COMPENSATION OR MONITORING MODE (cont.)

Although the control will automatically adjust the amplifier's gain to achieve best current control quality, improper choice of Current Sensor or *r.A.* value will cause overshooting or poor compensation quality during the Current Compensation process.

### MONITORING

With *C.r.=13, 15, 17* or *19* if using PT2, PT5, PT10 or PT20 as Current Sensor, the control will operate in PRIMARY PRESET-RANGE MONITORING mode. When the control operates in this MONITORING mode, the control will only display the weld current after a weld but will not compensate the current error. The value of CURRENT setting in the weld schedules should be input as the percentage of maximum current output of the control.

## 8.2.3 SECONDARY AUTO-RANGE COMPENSATION OR MONITORING MODE WITH ROGOWSKI COIL

In these modes, a learning-type setup process is required. With this learning-type setup process, the control will record the current values of maximum output, and constant current compensation will be based on this data. The learning-type setup process is described in Section 8.4. Normally these modes are used only when the current range of control is unavailable.

### COMPENSATION

With *C.r.=30*, the control will operate in SECONDARY AUTO-RANGE COMPENSATION mode with Rogowski Coil. When the control operates in this COMPENSATION mode and if *r.A.=00.99*, the value of PERCENT CURRENT setting in the weld schedules should be input as the percentage [%] of maximum current output of the control. Otherwise, *r.A.* should be set to the assumed maximum secondary CURRENT in [kA] value, and the value of PERCENT CURRENT setting in the weld schedules should be input as the required secondary output current in [kA] value of the control.

### MONITORING

With *C.r.=31*, the control will operate in SECONDARY AUTO-RANGE MONITORING mode with Rogowski Coil. When the control operates in this MONITORING mode, the control will only display the welding current after a weld but will not compensate the current error. The value of PERCENT CURRENT setting in the weld schedules should be input as the percentage [%] of maximum current output of the control.

## 8.2.4 PRIMARY AUTO-RANGE COMPENSATION OR MONITORING MODE WITH CURRENT TRANSFORMER

In these modes, a learning-type setup process is required. With a learning-type setup process, the control will record the current values of maximum output, and constant current compensation will be based on this data. The learning-type setup process is described in Section 8.4. Normally these modes are only used when the current range of control is unavailable.

## 8.2.4 PRIMARY AUTO-RANGE COMPENSATION OR MONITORING MODE WITH CURRENT TRANSFORMER (cont.)

### COMPENSATION

With  $C.r.=10$ , the control will operate in PRIMARY AUTO-RANGE COMPENSATION mode. When the control operates in this COMPENSATION mode and if  $r.A.=00.99$ , the value of PERCENT CURRENT setting in the weld schedules should be input as the percentage [%] of maximum current output of the control. Otherwise,  $r.A.$  should be input with the assumed maximum output of secondary current in [kA] value, and the value of PERCENT CURRENT setting in the weld schedules should be input as the desired secondary output current in [kA] value of the control.

### MONITORING

With  $C.r.=11$ , the control will operate in PRIMARY AUTO-RANGE MONITORING mode. When the control operates in this MONITORING mode, the control will only display the weld current after a weld but will not compensate the current error. The value of PERCENT CURRENT setting in the weld schedules should be input as the percentage [%] of maximum current output of the control.

## 8.3 DISPLAYING CURRENT AFTER WELD SEQUENCE

It is not necessary to program any special function or PROCESS OUTPUT to display CURRENT after the weld. Simply use the SELECT push button to display PERCENT CURRENT parameter before initiation. The control will display the measured CURRENT at the end of the sequence.

Before initiation of the sequence, select PERCENT CURRENT using the SELECT push button. After the end of sequence, the DATA display may show average RMS CURRENT in [kA] or [%]. If necessary, the control will display the range or tap indicator (**t. -UP** or **t. -dn**) messages. The display may be toggled between CURRENT in [kA] and real PHASE SHIFT PERCENT firing in [%] by pressing the DATA push buttons as follows:

- Pressing DATA 1s push button will show PERCENT;
- Pressing DATA 10s push button will show last measured CURRENT in [kA];
- Pressing any other push button will clear the display.

The following messages are readily available at the end of the sequence.

**Average RMS CURRENT in [kA]** – Shown on the display if the control is operating in the proper mode and a weld has been made. A valid operating mode for [kA] display is any mode that allows programming the control in [kA] in the weld schedule.

**PHASE SHIFT in [%]** – Selectable only if RMS CURRENT is displayed at the end of a weld. To show PERCENT, simply press the DATA 1s push button. This is useful to determine if the control has enough headroom to compensate for current losses whenever needed.

**Toggle between RMS CURRENT in [kA] and PHASE SHIFT in [%]** – RMS CURRENT in [kA] and PHASE SHIFT in [%] are selectable only if average RMS CURRENT is displayed at the end of a weld. To show PERCENT, simply press the DATA 1s push button. To show last measured RMS CURRENT in [kA], simply press the DATA 10s push button. To clear display, press any other push button.

## 8.3 DISPLAYING CURRENT AFTER WELD SEQUENCE (cont.)

**Tap UP (or Range DOWN) indicator ( $t-UP$ )** – Shown at the end of a weld sequence if the weld control is unable to compensate and maintain the programmed CURRENT. In this case, moving the tap selector, if exists, to a higher setting will allow the control to maintain the current constant. If machine is already at the highest tap setting, the maximum current range of machine is much lower than the programmed range in  $r.R$ . In this case, choose a lower current range from Table 8-1 and program the corresponding value in  $r.R$ .

PHASE SHIFT in [%] and RMS CURRENT in [kA] are also available during this condition. To show PERCENT while  $t-UP$  is displayed, simply press the DATA 1s push button. To show the RMS CURRENT in [kA], simply press the DATA 10s push button. To clear display, simply press any other push button.

**Tap DOWN (or Range UP) indicator ( $t-dn$ )** – Shown at the end of a weld sequence if the weld control is unable to compensate and maintain the programmed CURRENT. In this case, moving the tap selector, if exists, to a lower setting will allow the control to maintain the current constant. If machine is already at the lowest tap setting, the maximum current range of machine is higher than the programmed range in  $r.R$ . In this case, choose a higher current range from Table 8-1 and program the corresponding value in  $r.R$ .

PHASE SHIFT in [%] and RMS CURRENT in [kA] are also available during this condition. To show PERCENT while  $t-dn$  is displayed, simply press the DATA 1s push button. To show the RMS CURRENT in [kA], simply press the DATA 10s push button. To clear display, simply press any other push button.

### 8.3.1 USING CONSTANT CURRENT PROCESS OUTPUTS

The EN1001, while in any CONSTANT CURRENT mode, can be programmed to always provide a weld current readout at the end of any weld sequence, no matter what is shown on display before beginning of sequence. Several CONSTANT CURRENT PROCESS OUTPUTS function as defined in Section 5.4.7 and can be programmed to function as explained below.

To obtain an **End of Sequence Readout**, find  $P.O.$  in EXTENDED FUNCTIONS and program a value of  $P.O.=12$ . While in CONSTANT CURRENT mode, control will measure the value of current maintained during the weld and show this value on DATA display at the end of the sequence. If limit window is being monitored for HI/LO range, the value shown on the display will be the CURRENT maintained by control if it can maintain this value. If the control cannot maintain the set CURRENT value, **the control will flash L.o. or H. i.** (depending on the case).

To obtain an **End of Sequence Readout and PROCESS OUTPUT valve (Valve 3) alarm output**, find  $P.O.$  in EXTENDED FUNCTIONS and program a value of  $P.O.=13$ . While in CONSTANT CURRENT mode, control will measure the value of current maintained during the weld and show this value on DATA display at the end of the sequence. If limit window is being monitored for HI/LO range, the value shown on the display will be the CURRENT maintained by control if it can maintain this value. If the control cannot maintain the set CURRENT value, **the control will flash L.o. or H. i.** (depending on the case). In addition, **the control will turn Valve 3 ON for 0.5 seconds (30 cycles).**

### 8.3.1 USING CONSTANT CURRENT PROCESS OUTPUTS (cont.)

To **interrupt a REPEAT sequence or stop at the end of a weld**, find **P.O.** in EXTENDED FUNCTIONS and program a value of **P.O.=14**. While in CONSTANT CURRENT mode, control will measure the value of current maintained during the weld and show this value on DATA displays at the end of the sequence. If limit window is being monitored for HI/LO range, the value shown on the display will be the CURRENT maintained by control if it can maintain this value. If the control cannot maintain the set CURRENT value, **the control will display L.o. or H. i. permanently**. In addition, **the control will stop a REPEAT sequence if in REPEAT mode or stop the control from any further initiations**. In order to re-enable initiations, it is necessary to simply press any Front Panel push button to clear **H. i./L.o. ERROR**.

To obtain a **Weld Current Readout without monitoring HI/LO limit window**, program EXTENDED FUNCTION parameter **P.O.=12**. Program a value in WELD CURRENT parameters **H i.=00.99** or **H i.=[xx.xx]**, where *xx.xx* is close to the maximum available current. Program a value in WELD CURRENT parameter **L.o.=00.10**. Do not leave these values at zero. If they are left at zero, control uses default limit window of CURRENT value+10% for **H i.** and CURRENT value-10% for **L.o.**, and monitors default limit window as described above.

If any other **NON-CONSTANT CURRENT PROCESS OUTPUT** must be used, simply use the SELECT push button to indicate PERCENT CURRENT before weld initiation, as explained in previous section.

### 8.3.2 SETTING LIMIT WINDOW FOR CONSTANT CURRENT

The default (factory setting) current limit window for **P.O.=12-14** and **22-27** is set at  $\pm 10\%$  of PERCENT CURRENT. If specific HIGH or LOW limits different from default are needed, follow these steps:

1. Put the control in PROGRAM mode.
2. Select desired schedule.
3. Press SELECT push button until FUNCTION indicator LED is at PERCENT CURRENT.
4. Click the right SCHEDULE push button once and SCHEDULE display will show **L.o.** to indicate LOW limit.
5. Use the DATA push buttons to enter desired LOW limit and push ENTER to save setting.
6. Click the right SCHEDULE push button once and SCHEDULE display will show **H. i.** to indicate HIGH limit.
7. Use DATA push buttons to enter desired HIGH limit and push ENTER to save setting.
8. Press the PROGRAM/OPERATE push button to return control to OPERATE mode.

## 8.4 LEARNING-TYPE SETUP PROCESS FOR AUTO-RANGE WORKING MODE

The learning-type setup process is needed when the maximum current range is not available. By this setup process, the control will make several weld cycles and record the signal values from the Current Sensor, then set the gain for the embedded amplifier.

Follow the steps outlined in either of the next two sections (8.4.1 or 8.4.2) depending on which matches your control's specifications.

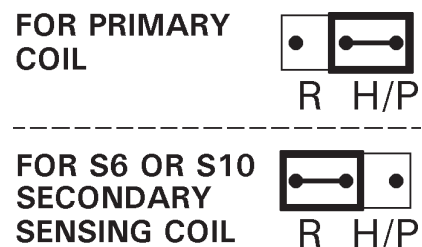
### 8.4.1 SETTING UP CURRENT REGULATOR (for Primary Sensor or Secondary Rogowski Coil with Auto-Range selection *only*)

1. Setup must be done in SPOT mode (**S.E.=00**). If doing seam welding, re-program SEAM mode parameter after the setup is complete. The control must be initiated using a FS3 initiation switch connected between TS1-FS3 and TS1-GND. If the machine does not have permanent initiations using this terminal, temporarily connect a switch to FS3.
2. Make sample welds with CONSTANT CURRENT disabled (**C.r.=00**) to determine proper welding transformer tap switch setting. PERCENT CURRENT should be between 70–80%\* and WELD time should be the recommended number of cycles for material being welded.
  - \* In order for the control to adapt to changing conditions, it must be able to adjust current. If weld is made around 75%, the control can move up to 99% or down to 20% if necessary to maintain current constant when the control is in CONSTANT CURRENT mode.
3. Put the control in PROGRAM mode.
4. Select EXTENDED FUNCTION **C.r.** and program **10** or **30**, depending on current sensing option.
5. Select EXTENDED FUNCTION **r.R.** and program:
  - 00.99** for operating in [%] mode, or
  - [**xx.xx**] for operating in [kA] mode (**xx.xx** is maximum RMS CURRENT in [kA]).
6. Select EXTENDED FUNCTION **C.R.**, program **04** on the DATA display, and press ENTER. This presets schedule 49 with specific setup parameters, including 30 cycles of SQUEEZE time, 99 cycles of SQUEEZE DELAY time, and Valve 1 output. The control will automatically switch to OPERATE mode and flash **S.P.t.** on the DATA display.

If necessary, SQUEEZE time or VALVE output may be changed to match machine requirements. Switch to PROGRAM mode, change SQUEEZE time or VALVE and press ENTER. Return to OPERATE mode.

7. Using the same material already welded\*\*, insert it between the machine electrodes, initiate a weld sequence and hold the initiation switch FS3 closed. The machine electrodes will close and the control will sequence through a preset test schedule. When setup is complete, the control counts down on the display and returns to schedule 00.
  - \*\* While in setup, the control makes multiple welds using 4 cycle pulses. If the part being welded cannot support weld times of 4 cycles without expulsion or distortion, the parameters measured may not provide correct setup data. In this case, run the setup with no material between the electrodes.
8. Release the initiation switch. The control is now set up and ready to operate. Sequence parameter CURRENT must be re-programmed now as a four-digit number (example: 80% = **0080**, or 15.7 kA = **15.70**). If needed, return to SEAM mode by programming **S.E.=01**, press ENTER, and return to OPERATE mode.

**NOTICE**  
Before running setup, make sure jumper on back side of Control Board is set in proper position (see Figure 8-3).



**Figure 8-3. Jumper settings**



## 8.4.2 SETTING UP CURRENT REGULATOR – BOARDS WITH PROMS BEFORE FIRMWARE VERSION 619016-001R (for archival purpose only)

1. Setup must be done in SPOT mode (**S.E.=00**). If doing seam welding, re-program parameter **S.E.** after setup. The control must be initiated using a FS3 initiation switch connected between TS1-FS3 and TS1-GND. If the machine does not have initiations using this terminal, temporarily connect a switch to FS3.
2. Using schedule 01, make sample welds in NON-CONSTANT CURRENT mode (**C.r.=00**) to determine the proper welding transformer tap switch setting. PERCENT CURRENT should be between 70% and 80%\* and WELD time should be the recommended number of cycles for material being welded.
  - \* In order for the control to adapt to changing conditions, it must be able to adjust current. If weld is made around 75%, the control can move up to 99% or down to 20% if necessary to maintain current constant when the control is in CONSTANT CURRENT mode.

### NOTICE

**DO NOT USE SCHEDULE 00 IN STEP 2!**

3. Switch to PROGRAM mode.
  - a) Select EXTENDED FUNCTION **C.r.**, program **10**, and press ENTER.
  - b) Select EXTENDED FUNCTION **r.A.**, program **00.99**, and press ENTER.
  - c) Select EXTENDED FUNCTION **C.A.**, program **04**, and press ENTER. This presets schedule 00 with specific setup parameters, including 30 cycles of SQUEEZE time and VALVE 1 output.
  - d) You may change SQUEEZE time to match machine requirements, and press ENTER.
  - e) You may change VALVE Output to match machine requirements, and press ENTER.

### NOTICE

**DO NOT MAKE ANY OTHER CHANGES!**

4. Switch to OPERATE mode. At this time, the DATA display should flash **S.P.t.**
5. Using the same material already welded \*\*, insert it between the machine electrodes, initiate a weld sequence and hold the initiation switch closed. The machine electrodes will close and the control will sequence through a preset test schedule. When it is finished, it will display ERROR CODE **05**.
  - \*\* While in setup, the control makes multiple welds at 99% for 4 cycles. If the part being welded cannot support weld times of 4 cycles at 99% without expulsion or distortion, the parameters measured may not provide correct setup data. In this case, run the setup with no material between the electrodes.

6. Release the initiation switch. The control is now set up and ready to operate. PERCENT CURRENT must be re-programmed now as a four-digit number (example: 80% = **0080**).



## 9.0 APPLICATIONS AND PROGRAMMING EXAMPLES

The EN1000/EN1001 Controls can be programmed for numerous welding applications, but only few of them are highlighted here.

The schedules shown are for demonstration purposes. In order to easily follow visually the schedules as they progress, the individual times in each one have been made longer than they would be for an actual machine operation.

### 9.1 SPOT MODE EXAMPLES

#### 9.1.1 SPOT WITH REPEAT MODE

Schedule 00 is a SPOT schedule in the REPEAT mode. Momentary initiation results in one sequence only. If the initiation is held closed, the sequence will continue repeating. Valve 2 output is used.

SCHEDULE	SQUEEZE	WELD/HEAT	PERCENT CURRENT	HOLD	OFF	IMPULSES	COOL	VALVE MODE	CYCLE MODE	SLOPE MODE	SLOPE COUNT
00	40	30	60	10	15	01	00	02	01	00	00

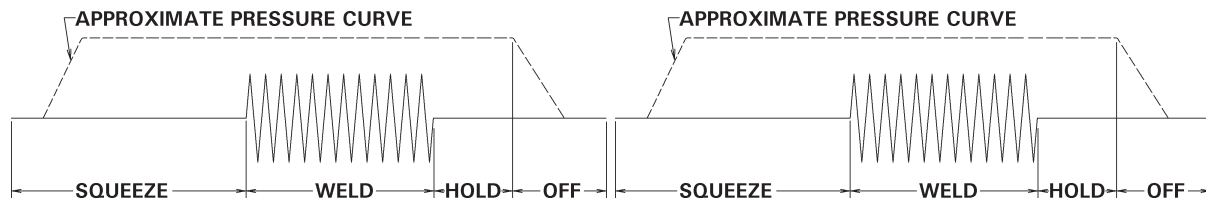


Figure 9-1. SPOT with REPEAT mode

#### 9.1.2 PULSATION WITH SUCCESSIVE MODE

Schedule 01 and 02 are PULSATION and SPOT schedules combined in the SUCCESSIVE mode. Schedule 01 is initiated first. When it is completed, schedule 02 will flash to indicate that it is ready to be initiated. After it is completed, the SCHEDULE display will return to 01. Schedule 01 uses Valve 1, schedule 02 uses Valve 2.

SCHEDULE	SQUEEZE	WELD/HEAT	PERCENT CURRENT	HOLD	OFF	IMPULSES	COOL	VALVE MODE	CYCLE MODE	SLOPE MODE	SLOPE COUNT
01	20	10	60	10	10	03	06	01	03	00	00
02	25	30	60	10	10	01	00	02	00	00	00

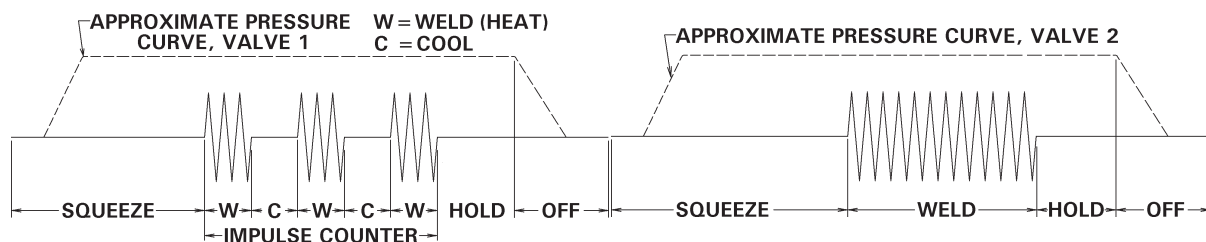


Figure 9-2. PULSATION with SUCCESSIVE mode

### 9.1.3 QUENCH-TEMPER WITH CHAINED MODE

Schedules 03 and 04 are CHAINED together to illustrate QUENCH-TEMPER operation. Schedule 03 performs the SQUEEZE, WELD and QUENCH functions (using HOLD for QUENCH), and schedule 04 performs the TEMPER and HOLD functions (using WELD for TEMPER). Valve 3 output is used. The WELD light gives a visual indication of the relative amplitude and duration of CURRENT during WELD and TEMPER times.

SCHEDULE	SQUEEZE	WELD/ HEAT	PERCENT CURRENT	HOLD	OFF	IMPULSES	COOL	VALVE MODE	CYCLE MODE	SLOPE MODE	SLOPE COUNT
03	40	35	60	35	10	01	00	04	02	00	00
04	00	30	40	20	10	01	00	04	00	00	00

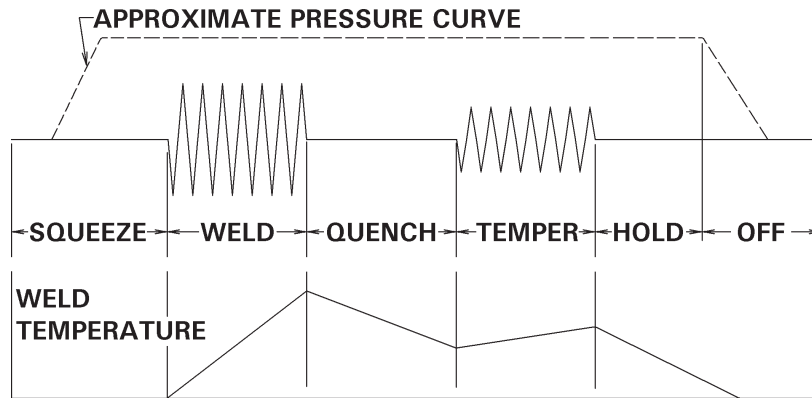


Figure 9-3. *QUENCH-TEMPER with CHAINED mode*

### 9.1.4 UPSLOPE AND DOWNSLOPE WITH CHAINED MODE

Schedules 05, 06, 07 and 08 are CHAINED together to illustrate UPSLOPE/DOWNSLOPE operation. Schedule 05 performs SQUEEZE function and establishes PERCENT CURRENT at which UPSLOPE will begin (bottom current). Schedule 06 performs WELD function and sets UPSLOPE time. Schedule 07 sets DOWNSLOPE time and PERCENT CURRENT it starts from. Schedule 08 establishes PERCENT CURRENT at which DOWNSLOPE will end, and performs HOLD function. The number in the SCHEDULE display will change as the sequence progresses from one schedule to the next. Valve 1 output is used for this example.

SCHEDULE	SQUEEZE	WELD/ HEAT	PERCENT CURRENT	HOLD	OFF	IMPULSES	COOL	VALVE MODE	CYCLE MODE	SLOPE MODE	SLOPE COUNT
05	40	00	10	00	00	01	00	01	02	00	00
06	00	20	60	00	00	01	00	01	02	01	20
07	00	00	60	00	00	01	00	01	02	02	22
08	00	00	05	20	10	01	00	01	00	00	00

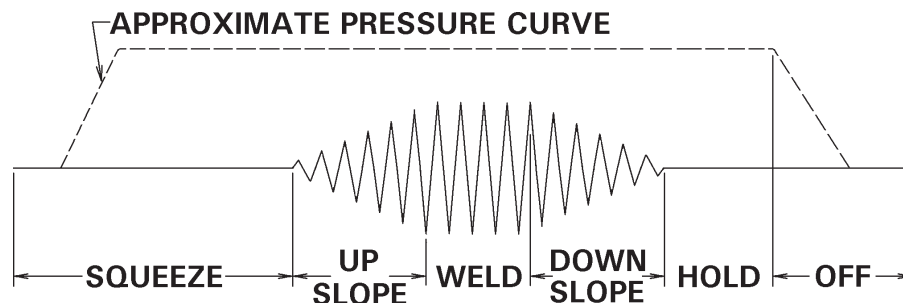


Figure 9-4. *UPSLOPE and DOWNSLOPE with CHAINED mode*

### 9.1.5 BUTT WELD WITH CHAINED MODE

Schedules 11 and 12 are CHAINED together to perform a BUTT welding sequence. Schedule 11 contains only SQUEEZE time with Valve 1 output, and is used as the CLAMP function. Schedule 12 follows the CLAMP function with a normal SQUEEZE, WELD, HOLD sequence with Valve 2 output. Both valve outputs turn off at the end of HOLD time.

SCHEDULE	SQUEEZE	WELD/HEAT	PERCENT CURRENT	HOLD	OFF	IMPULSES	COOL	VALVE MODE	CYCLE MODE	SLOPE MODE	SLOPE COUNT
11	20	00	00	00	00	01	00	01	02	00	00
12	20	10	50	10	10	01	00	03	00	00	00

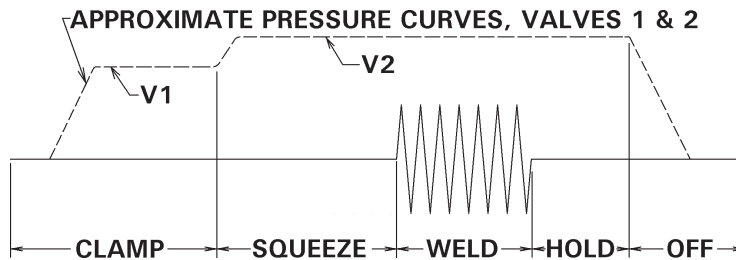


Figure 9-5. BUTT weld with CHAINED mode

### 9.1.6 FORGE DELAY WITH CHAINED MODE

The forging process is most often used when working with hard-to-weld materials such as aluminum. The weld is usually started at one force, followed by the application of a higher force during weld or hold time. This action may refine the weld zone, and provide a more homogeneous weld nugget. Timing of the application of forging force is critical. If applied too soon, the welding current may be insufficient for the higher force. If applied too late, the weld will have solidified and the forging force will do no good.

FORGE DELAY is defined as the delay from the beginning of the weld to the activation of the forging solenoid valve. To accomplish a FORGE DELAY operation on EN1000/EN1001 Series Controls, it is necessary to CHAIN together two or more schedules as outlined below.

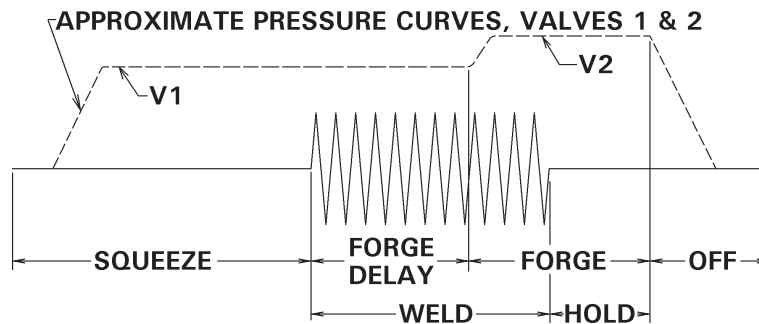
1. Program the first schedule with the amount of WELD time desired before the activation of the forging valve. Use any one of the three solenoid valve outputs.
2. For FORGE during WELD, program the second schedule with remaining WELD time and program an unused valve output. This second valve output activates the forging valve.

<b>NOTICE</b>											
For continuous CURRENT from the first schedule to the second schedule, do not program any HOLD time into the first schedule or SQUEEZE time into the second schedule.											

3. For FORGE after WELD, program the number of cycles of time between WELD time and the activation of the forge valve into HOLD time of the first schedule or into SQUEEZE time of the second schedule.

SCHEDULE	SQUEEZE	WELD/HEAT	PERCENT CURRENT	HOLD	OFF	IMPULSES	COOL	VALVE MODE	CYCLE MODE	SLOPE MODE	SLOPE COUNT
00	xx	xx	xx	00	00	01	00	02	02	00	00
01	00	xx	xx	xx	00	01	00	06	00	00	00

## 9.1.6 FORGE DELAY WITH CHAINED MODE (cont.)



**Figure 9-6.** *FORGE DELAY with CHAINED mode*

In the next example, Valve 1 will be the standard valve and Valve 2 will be the forging valve. The total WELD time is 15 cycles at 95 PERCENT CURRENT with the forging valve activated after 10 cycles.

SCHEDULE	SQUEEZE	WELD/ HEAT	PERCENT CURRENT	HOLD	OFF	IMPULSES	COOL	VALVE MODE	CYCLE MODE	SLOPE MODE	SLOPE COUNT
00	20	10	95	00	00	01	00	01	02	00	00
01	00	05	95	20	00	01	00	03	00	00	00

For FORGE during WELD, it is possible to select a PERCENT CURRENT for the second schedule different from that of the first schedule.

Other combinations of weld schedules may be combined to create other forging schedules. For example, it would be possible to use UPSLOPE in the first sequence and PULSATION in the second sequence.

## 9.2 SEAM MODE EXAMPLES

### 9.2.1 CONTINUOUS SEAM MODE

Schedule 13 is a CONTINUOUS SEAM mode. The control is switched to the SEAM mode by programming the EXTENDED FUNCTION **5.E.** to **01**. Welding current starts when the initiation contact is closed, and stays on as long as it is held closed.

SCHEDULE	SQUEEZE	WELD/HEAT	PERCENT CURRENT	HOLD	OFF	IMPULSES	COOL	VALVE MODE	CYCLE MODE	SLOPE MODE	SLOPE COUNT
13	10	01	40	10	10	01	00	01	00	00	00

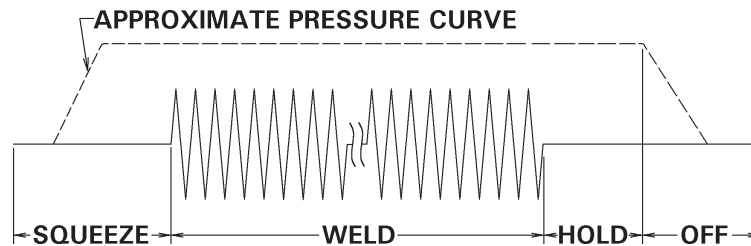


Figure 9-7. CONTINUOUS SEAM mode

### 9.2.2 INTERMITTENT SEAM MODE

Schedule 14 is an INTERMITTENT SEAM mode. INTERMITTENT operation is accomplished by programming a value other than **00** for COOL into the schedule. To switch the control back to the SPOT mode, program the EXTENDED FUNCTION **5.E.** to **00**.

SCHEDULE	SQUEEZE	WELD/HEAT	PERCENT CURRENT	HOLD	OFF	IMPULSES	COOL	VALVE MODE	CYCLE MODE	SLOPE MODE	SLOPE COUNT
14	10	20	40	10	10	01	05	01	00	00	00

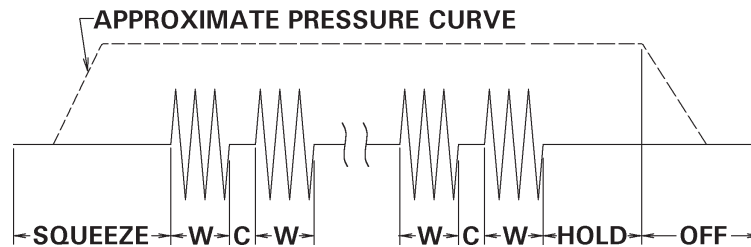


Figure 9-8. INTERMITTENT SEAM mode

### 9.2.3 WELD CURRENT DELAY

WELD CURRENT DELAY provides a time delay and output to a seam welding machine solenoid valve circuit. When the weld wheels are lowered, a delay before applying weld current is required to insure the wheels are together and sufficient pressure is attained. WELD CURRENT DELAY is represented by SQUEEZE time on the Front Panel.

To add WELD CURRENT DELAY to a SEAM sequence, program desired SQUEEZE time to the first schedule of the SEAM sequence. If the sequence is programmed for INTERMITTENT SEAM or ROLL SPOT, the programmed SQUEEZE time will only be in effect upon initiation.

To return the control back to SPOT mode, the EXTENDED FUNCTION **5.E.** must be programmed to **00** (see Section 5.4.2).

## 9.2.4 SEAM MODE 5.E.=06

This mode was primarily designed as a NON-BEAT SEAM mode. It enables a user to execute a fixed time weld using a number of repetitions in addition to alternating two heats within single schedule.

The control is programmed as follows:

1. Use the SELECT push button until the DATA display shows **EF**.
2. Use the SCHEDULE push buttons to find **5.E.** in the SCHEDULE display.
3. Program a value **5.E.=06** and press the ENTER push button.
4. Use the following information to program working schedule.

### NOTICE

By definition, the SEAM mode is a BEAT mode operation. In a normal SEAM mode, CHAINED mode of welding schedules is not available.

SQUEEZE count		[normal SQUEEZE]
WELD/HEAT count	[WELD 1]	[normal WELD time]
PERCENT CURRENT	[PERCENT 1]	[normal PERCENT]
HOLD count		[normal HOLD time]
OFF count	[PERCENT 2]	[new second PERCENT heat]
IMPULSES	[Weld(1+2)*Factor]	[repetition factor for overall WELD time]
COOL count	[WELD 2]	[new COOL will execute a second WELD/HEAT]
VALVE MODE		[normal VALVE MODE]
CYCLE MODE		[normal CYCLE MODE]
SLOPE MODE		[normal SLOPE MODE]
SLOPE COUNT		[normal SLOPE COUNT]

In order to obtain a long series of heat patterns, the schedules can be CHAINED as normal to execute a second, third or more subsequent schedules with a similar set of heat patterns. Example:

SCHEDULE	SQUEEZE	WELD/HEAT	PERCENT CURRENT	HOLD	OFF	IMPULSES	COOL	VALVE MODE	CYCLE MODE	SLOPE MODE	SLOPE COUNT
		WELD1			WELD2						
01 slope	05	00	10	00	00	01	00	01	02	00	00
02 seq.A	05	01	50	00	70	37	02	01	02	01	10
03 seq.B	05	01	55	00	85	54	02	01	02	01	10
04 seq.C	05	01	50	00	95	16	02	01	02	01	10
05 seq.D	05	01	40	10	70	15	02	01	02	01	10

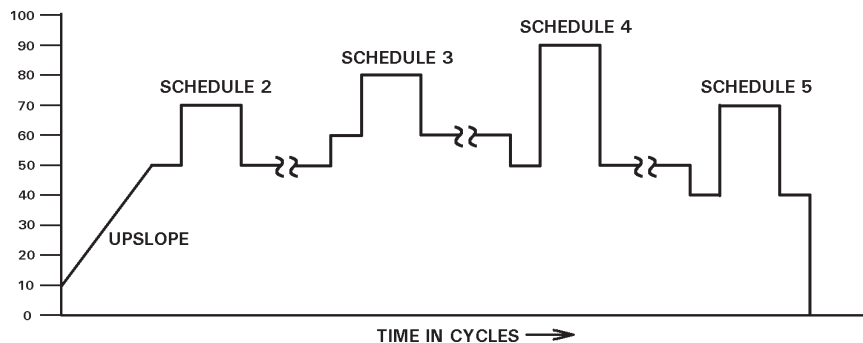


Figure 9-9. NON-BEAT SEAM mode

## 9.3 BRAZING APPLICATION

Brazing operations differ from spot welding operations in that a much longer heating time may be required. This is because a much larger area must be raised to the melting temperature of the brazing material. Depending on the mass of the parts to be brazed, this time may vary from several cycles to several seconds. The EN1000/EN1001 Controls can be operated in two BRAZING modes: AUTOMATIC for short brazing times and MANUAL which is most useful for long brazing times.

### 9.3.1 AUTOMATIC BRAZING MODE

For the AUTOMATIC BRAZING mode, the EN1000/EN1001 is initiated in the same manner as for SPOT welding. However, it must be programmed through the EXTENDED FUNCTIONS for BEAT INITIATION DURING SQUEEZE AND WELD, in accordance with instructions in Section 5.4.8. For convenience, these instructions are repeated here.

To program for BEAT DURING SQUEEZE AND WELD:

1. Put the control in PROGRAM mode.
2. Use SELECT to find **EF**.
3. Use the SCHEDULE push buttons to find **b.E**.
4. Use the DATA push buttons and make **b.E.=02**.
5. Press ENTER.

In this mode, the initiation must be held closed for the time required to bring the parts to the required brazing temperature. If this time is longer than 99 cycles, two or more schedules must be CHAINED together. If the operator then opens the initiation, the brazing current turns off immediately and the sequence advances to HOLD time, and after HOLD time the electrodes retract. The control will terminate the weld sequence normally at the end of the programmed schedule if the initiation switch remains closed.

### 9.3.2 MANUAL BRAZING MODE

For the MANUAL BRAZING mode, BEAT INITIATION DURING SQUEEZE AND WELD is also programmed as above. In addition, set WELD/HEAT and IMPULSES to **99**, PERCENT CURRENT and VALVE MODE in accordance with job requirements, and all other parameters to **00**. Initiation switches are connected to TS1 as shown in Figure 9-10.

Operation in this mode is as follows: When First Stage is closed, brazing electrodes close on the work. When Second Stage is closed, brazing current comes on. If Second Stage is opened, brazing current stops, but electrodes stay closed. Current may be turned on and off in this manner as many times as desired by operator. When First Stage is opened, electrodes retract.

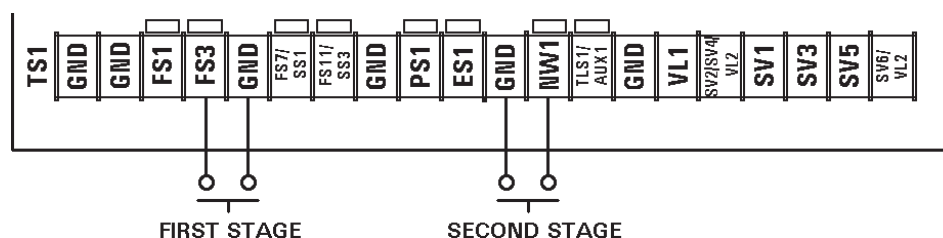


Figure 9-10. Using Two Stage initiation in BRAZING mode



## 9.4 SQUEEZE DELAY APPLICATION

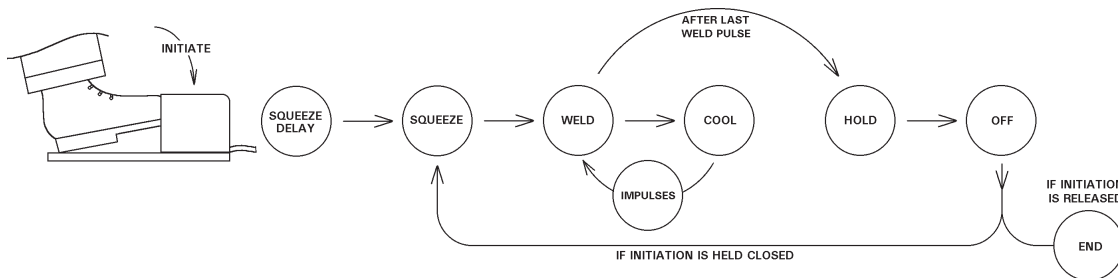
Some applications require the welder arms be opened wide to allow the electrodes to access areas to be welded. SQUEEZE DELAY was designed for use with welding guns and stationary machines incorporating standard air cylinders and valves without retraction features. The additional time provided by the SQUEEZE DELAY will allow the electrodes to travel a greater distance and simulate the retraction function. SQUEEZE DELAY is only active in the first schedule in a REPEAT sequence.

### 9.4.1 SQUEEZE DELAY OPERATION

Setting the control for SQUEEZE DELAY will provide additional time before the programmed SQUEEZE time in all schedules. The SQUEEZE indicator LED on the Control Panel will dim slightly during the programmed SQUEEZE DELAY time. SQUEEZE DELAY time occurs only during the first SQUEEZE of a series of repeated welding sequences (REPEAT mode).

SQUEEZE DELAY will be present in all schedules even if no other data has been entered.

SQUEEZE DELAY is not intended for use with SEAM or ANTI-TIE DOWN modes of operation. If not required, set **S.d.** to **00**.



**Figure 9-11.** *SQUEEZE DELAY operation*

### 9.4.2 SQUEEZE DELAY PROGRAMMING

1. Press SELECT push button repeatedly until FUNCTION indicator LED has advanced past SLOPE COUNT to enter data in EXTENDED FUNCTIONS (**EF**).
2. Move through the EXTENDED FUNCTIONS until **S.d.** appears in SCHEDULE display.
3. Press PROGRAM/OPERATE push button to place the control in PROGRAM mode.
4. Press DATA push buttons until desired SQUEEZE DELAY time (time=number of cycles) is displayed in DATA display.
5. Press ENTER push button to store the desired data.
6. Select and enter CYCLE MODE=**01** (REPEAT).
7. Adjust SQUEEZE and OFF times to allow the electrodes to open only a short distance between repeated welding sequences.
8. Press PROGRAM/OPERATE push button to put the control in OPERATE mode.

## 9.5 RETRACTION APPLICATION

Retraction is used for welding guns and stationary machines with cylinders and valves configured for retraction operation. Retraction can be accomplished by de-energizing a valve solenoid, allowing the electrode arms to separate further than normal to allow large parts to be placed between welding electrodes.

The retraction valve can be activated by a *momentary (P.O.=08)* switch closure that toggles the electrodes between the retracted and non-retracted state or a *maintained (b.S.=09)* closure. AIR OVER OIL RETRACTION (*P.O.=07*) is used on welding guns and stationary welders that incorporate special air over oil cylinders

### 9.5.1 MOMENTARY CLOSURE – P.O.=08

While the RETRACTION PROCESS OUTPUT is enabled, the TS1-TLS1/AUX1 terminal is configured as a retraction input. The Temperature Limit Switch normally connected to terminal TS1-TLS1/AUX1 should be moved to TS1-TLS1/NW1. A momentary closure from TS1-TLS1/AUX1 to TS1-GND will toggle the valve from the ON to the OFF state. These contacts are normally tied to a momentary type switch that is independent from the initiation switch. When the valve is off and the gun is in a fully retracted state, the control cannot initiate a weld sequence and an ERROR *Err.=27* message will appear on the display if initiation is attempted. Only when the valve is on and the electrodes are in the pre-weld or extended position will the initiations be enabled. When Valve 3 is on, VALVE 3 indicator LED on the Control Panel will be blinking.

The valve output between TS1-SV5 and TS1-SV6 is enabled by toggling the TS1-TLS1/AUX1 to TS1-GND switch. This output remains on during and after a weld as long as switch is not activated.

SUCCESSIVE schedules can be used with MOMENTARY RETRACTION.

When the retraction valve is on, the control may not be placed into PROGRAM mode. The TS1-TLS1/AUX1 (retraction input) must be momentarily activated.

If the TS1-TLS1/AUX1 input switch is held **closed** for a long period of time, ERROR *Err.=06* message will be displayed, but the error condition is abandoned and the valve output **will be toggled** upon the opening of TS1-TLS1/AUX1 from TS1-GND. The Control Panel indication of Valve 3 output (retraction valve) will not indicate the status of PROCESS OUTPUT.

## 9.5.1 MOMENTARY CLOSURE – *P.O.=08* (cont.)

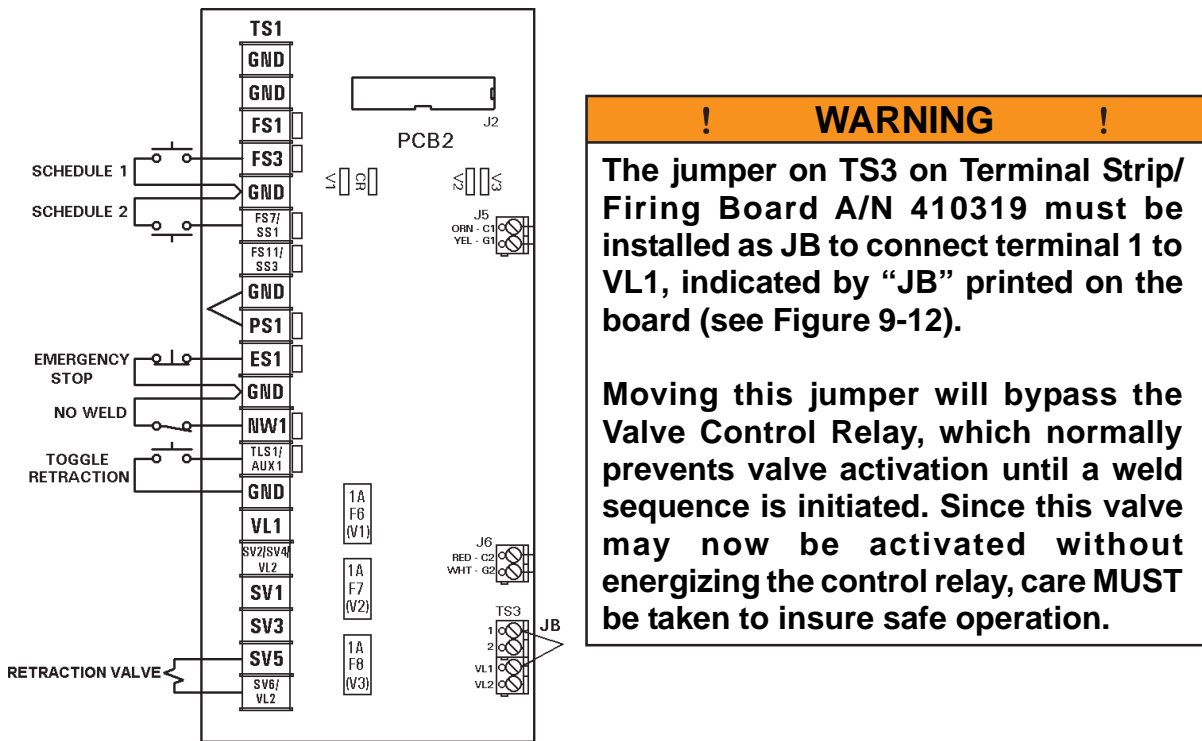


Figure 9-12. Momentary Retraction connections

## PROGRAMMING MOMENTARY RETRACTION

1. Provide a constant closure of TS1-TLS1/AUX1 to TS1-GND.
2. Press SELECT push button repeatedly until FUNCTION indicator LED has advanced past SLOPE COUNT to enter data in EXTENDED FUNCTIONS (**EF**).
3. Scroll through the EXTENDED FUNCTIONS until **P.O.** appears in SCHEDULE display.
4. Press PROGRAM/OPERATE push button to place the control in PROGRAM mode.
5. Use the DATA push buttons to display **08** in DATA display.
6. Press ENTER push button to store the data.
7. Open the retraction switch held closed in Step 1.
8. Press PROGRAM/OPERATE push button to put the control in OPERATE mode.

## 9.5.2 MAINTAINED CLOSURE – *b.5.=09* (THREE STAGE FOOT-SWITCH RETRACTION ADDITION)

EN1000/EN1001 Series Controls incorporating PROM firmware version 619016-002R or later will have the Maintained Closure Retraction feature added.

Once **b.5.** is set to **09**, the control will enter the MAINTAINED CLOSURE RETRACTION mode. This RETRACTION implementation is different from **P.O.=07** or **P.O.=08** in that it uses one foot switch that has a maintained/latched contact that the control uses to turn on the retraction output Valve 3. The software has a power-on interlock of the Valve 3 output to block Valve 3 from turning on with power on. This feature, simple as its operation may be, will help users implement this type of retraction without putting high voltage on one pole and/or in the same conduit as the low voltage foot switch wiring.

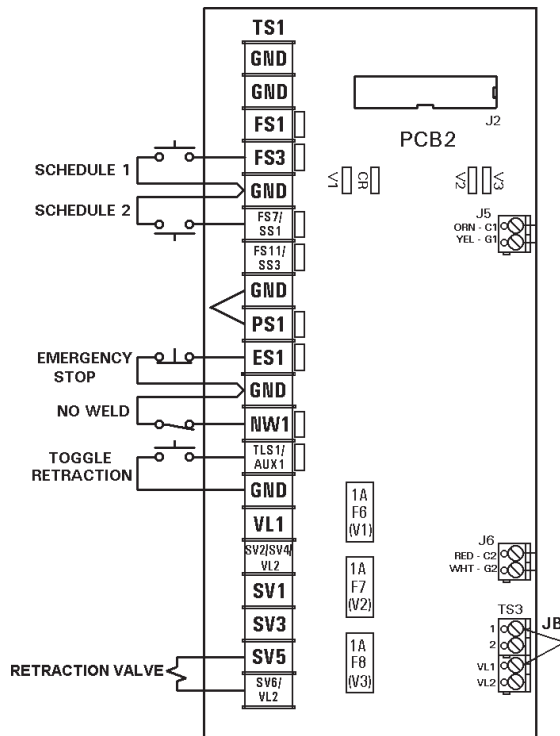
## 9.5.2 MAINTAINED CLOSURE – b.5.=09 (cont.)

The valve output between TS1-SV5 and TS1-SV6 is enabled by closing the TS1-TLS1/AUX1 to TS1-GND switch. This output remains on during and after a weld as long as the switch remains closed.

SUCCESSIVE schedules can be used with MAINTAINED CLOSURE RETRACTION.

When the retraction valve is on, the control may not be placed into PROGRAM mode.

The Control Panel indication of Valve 3 output (retraction valve) will not indicate the status of PROCESS OUTPUT.



**Figure 9-13.** *Maintained Closure Retraction connections*

! WARNING !

The jumper on TS3 on Terminal Strip/ Firing Board A/N 410319 must be installed as JB to connect terminal 1 to VL1, indicated by “JB” printed on the board (see Figure 9-13).

Moving this jumper will bypass the Valve Control Relay, which normally prevents valve activation until a weld sequence is initiated. Since this valve may now be activated without energizing the control relay, care **MUST** be taken to insure safe operation.

### PROGRAMMING MAINTAINED CLOSURE RETRACTION

1. Provide a constant closure of TS1-TLS1/AUX1 to TS1-GND.
2. Press SELECT push button repeatedly until FUNCTION indicator LED has advanced past SLOPE COUNT to enter data in EXTENDED FUNCTIONS (**EF**).
3. Scroll through the EXTENDED FUNCTIONS until **b.5.** appears in SCHEDULE display.
4. Press PROGRAM/OPERATE push button to place the control in PROGRAM mode.
5. Use the DATA push buttons to display **09** in DATA display.
6. Press ENTER push button to store the data.
7. Open the retraction switch held closed in Step 1.
8. Press PROGRAM/OPERATE push button to put the control in OPERATE mode.

### 9.5.3 AIR OVER OIL RETRACTION OPERATION – P.O.=07

Air over Oil Retraction is used on welding guns and stationary welders that incorporate special air over oil cylinders. This function is only available in PROM firmware version 619016-002G (or later).

This feature requires the use of three solenoid valve outputs. The first output (Valve 1) is assigned to the *extend* solenoid. When the control is initiated, the *extend* valve is turned on, and the electrodes will approach the work under low pressure. The *intensify* valve (Valve 2) is then turned on once the electrodes reach the work and welding pressure is applied. The control continues onto WELD time and HOLD time. At the end of HOLD time, both the *extend* and *intensify* valves are shut off and a BLOCKING DELAY timer is then started. At the end of BLOCKING DELAY, the *blocking* valve (Valve 3) is turned on. This valve is connected to the *extend* port of the cylinder and when energized or closed, the return stroke can be halted before the gun completely opens. Initiating the *extend* valve will de-energize the *blocking* valve.

AIR OVER OIL RETRACTION is available through EXTENDED FUNCTION P.O.=07.

Because of the longer time that is required for the electrodes to go from the fully retracted state to the closed state, a SQUEEZE DELAY time is necessary. The SQUEEZE DELAY time is in addition to any scheduled SQUEEZE time. The control will only go through SQUEEZE DELAY when initiated from a fully retracted state. If the control is initiated when the *blocking* valve is on, the control will not go through SQUEEZE DELAY.

### RETRACTION TOGGLE

When the control is programmed for AIR OVER OIL RETRACTION, FS1 can be used as an input to advance/retract the gun. When extending, the gun will advance during the programmed SQUEEZE DELAY time (using Valve 1). Valve 1 will de-energize and ADVANCE STOP will begin. Valve 3 will turn on immediately after the programmed ADVANCE STOP time (programmed OFF time on schedule 00 in Figure 9-15).

The following steps assume that a *blocking* valve is connected between TS1-SV5 and TS1-SV6 (Valve 3 output):

1. Connect a normally open momentary close type switch between TS1-FS1 and TS1-GND.
2. Program SQUEEZE DELAY to time the advance of the gun to a ready position.
3. Program an OFF time in the first of the two schedules composing the weld sequence. This OFF time is designated as ADVANCE STOP time. This time will only occur during the FS1 toggle activation. It will not affect an actual weld sequence, since the first schedule is a non-welding part of the sequence.

#### NOTICE

The timing of SQUEEZE DELAY (Step 2) and OFF/ADVANCE STOP (Step 3) is counted in half cycle increments in order to double adjustment resolution.

To advance the electrodes, a momentary closure of FS1 will energize Valve 1.

The *blocking* valve will turn on immediately at the end of a programmed ADVANCE STOP time. Travel distance will depend on SQUEEZE DELAY plus ADVANCE STOP. In addition, inertia of the gun, oil pressure, etc., may influence travel distance.

### 9.5.3 AIR OVER OIL RETRACTION OPERATION – P.O.=07 (cont.)

While the *blocking* valve is energized, the Control Panel will indicate this status by blinking the VALVE 3 LED. In this state, the control does not allow programming changes.

To return the electrodes to a fully retracted state, a momentary closure of FS1 will de-energize Valve 3. The Emergency Stop input may also be used to retract the electrodes. The Valve 3 output will remain off after the Emergency Stop is activated.

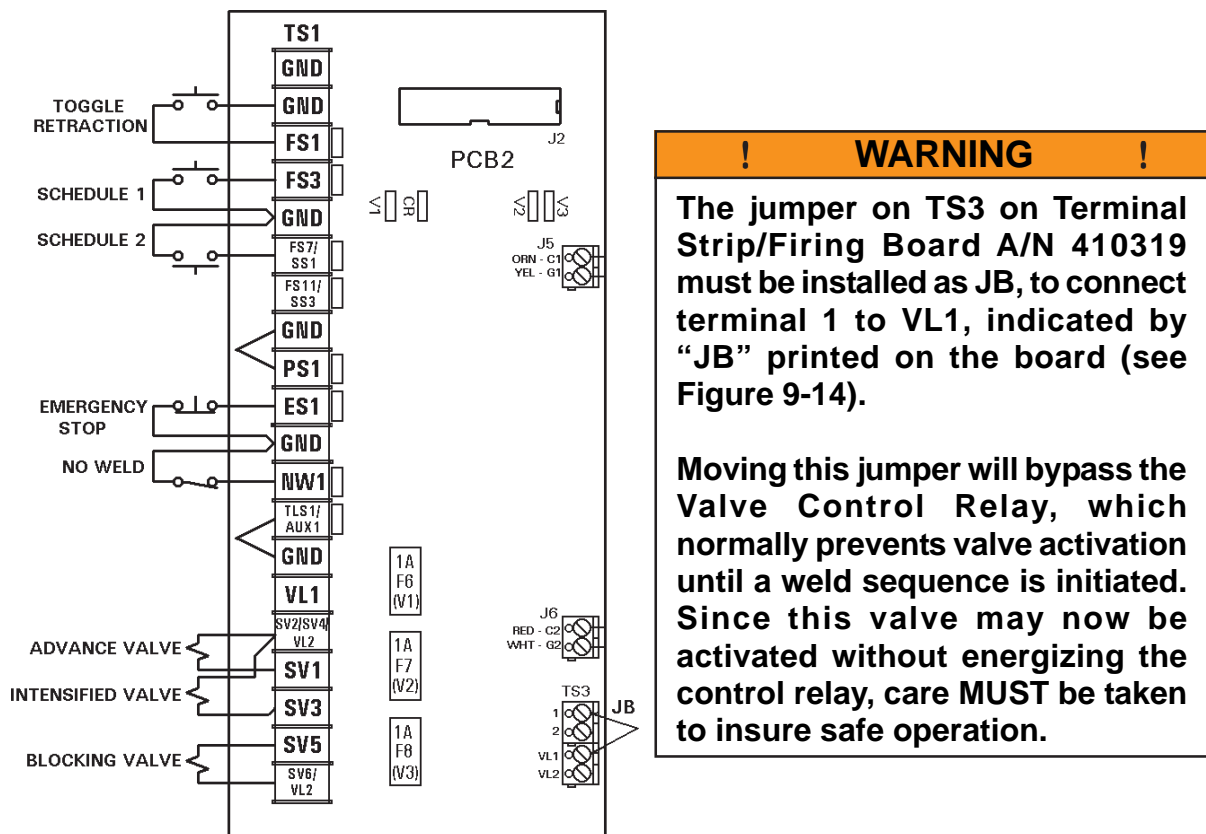
In REPEAT sequences when programmed OFF time is shorter than or equal to BLOCKING time, only BLOCKING DELAY time takes place. When OFF time is greater than BLOCKING time, the *blocking* valve will turn on at the end of BLOCKING DELAY time and the control will continue through an OFF time that is equal to OFF time minus BLOCKING time.

When the control is in sequence and is in SQUEEZE DELAY or in BLOCKING DELAY time periods, the SQUEEZE and OFF indicator LEDs (respectively) will dim to half their intensity while the control continues through these times.

When P.O.=07 is enabled, SQUEEZE DELAY time and BLOCKING DELAY time are in place for all 50 schedules.

SUCCESSIVE schedules can be used with AIR OVER OIL RETRACTION.

BEAT DURING SQUEEZE (b.E.=01) by definition will not work well with PROCESS OUTPUT 07 as the electrodes will completely open and the *blocking* valve will not turn on.



**Figure 9-14.** Air Over Oil Retraction connections

### 9.5.3 AIR OVER OIL RETRACTION OPERATION – P.O.=07 (cont.)

#### PROGRAMMING AIR OVER OIL RETRACTION

1. Press SELECT push button repeatedly until FUNCTION indicator LED has advanced past SLOPE COUNT to enter data in EXTENDED FUNCTIONS (**EF**).
2. Scroll through the EXTENDED FUNCTIONS until **P.O.** appears in the SCHEDULE display.
3. Press PROGRAM/OPERATE push button to place the control in the PROGRAM mode.
4. Use the DATA push buttons to display **07** in DATA display.
5. Press ENTER push button to store the data.
6. Scroll through the EXTENDED FUNCTIONS until **S.d.** appears in the SCHEDULE display.
7. Press the DATA push buttons until the desired SQUEEZE DELAY time is displayed in the DATA display (time = number of cycles).
8. Press ENTER push button to store the data.
9. Press SCHEDULE push buttons to advance SCHEDULE display to **b.L.** (BLOCKING DELAY).

#### NOTICE

**EXTENDED FUNCTION *b.L.* can only be accessed when P.O.=07 is programmed.**

10. Press the DATA push buttons until desired BLOCKING DELAY time appears in DATA display.
11. Press ENTER push button to store the data.
12. Using the example below, enter CHAINED schedules that will control the *extend* (schedule 00) and *intensify* (schedule 01) valve sequencing.

#### NOTICE

**Schedule 00 uses Valve 1 to activate the *extend* valve for 20 cycles.**

SCHEDULE	SQUEEZE	WELD/ HEAT	PERCENT CURRENT	HOLD	OFF	IMPULSES	COOL	VALVE MODE	CYCLE MODE	SLOPE MODE	SLOPE COUNT
00	20	10	00	00	05	01	00	01	02	00	00
01	10	15	85	10	00	01	00	03	00	00	00

## 9.5.3 AIR OVER OIL RETRACTION OPERATION – P.O.=01 (cont.)

### TIMING CHART ANALYSIS

Detailed sequencing of the cylinder can be better understood by studying sequence timing charts (see Figure 9-15) which are discussed in the following sections.

#### Section A

Section A details a basic sequence and how it may begin. The *blocking* valve may be on or off and will be cleared by an Emergency Stop. FS3 is then initiated and schedule 00 is started.

Since the *blocking* valve is off, the sequence begins with SQUEEZE DELAY (if programmed) and then proceeds into SQUEEZE time (EXTEND). A VALVE MODE of **01** is selected to turn on Valve 1 only. Schedule 00 is CHAINED to schedule 01. Schedule 01 begins and enters into SQUEEZE time (INTENSIFY), WELD time, and HOLD time. A VALVE MODE of **03** is selected to enable both Valve 1 (*extend*) and Valve 2 (*intensify*). After HOLD time is complete, the BLOCKING DELAY (if programmed) begins. When this DELAY is complete, Valve 3 (*blocking*) turns on. The control then waits for the next initiation, leaving the *blocking* valve on.

#### Section B

Section B is the same as Section A but, since Valve 3 (*blocking*) is on, the sequence skips SQUEEZE DELAY and immediately begins schedule 00 with SQUEEZE time (EXTEND).

#### Section C

Section C illustrates how a sequence can be terminated by an Emergency Stop. When the Emergency Stop is detected, the sequence is aborted and all valves and weld output are turned off. As can be seen, when the Emergency Stop is closed, the *blocking* valve is not turned back on.

#### Section D

Section D shows a single sequence similar to Section A, followed by a REPEAT sequence. Since OFF time is less than BLOCKING time, the sequence will REPEAT when the BLOCKING time has ended.

#### Section E

Section E illustrates that different schedules may be selected having common SQUEEZE DELAY and BLOCKING times.

#### Section F

Section F shows how a momentary switch attached to FS1 can toggle the gun from retracted to non-retracted mode or vice-versa. After a momentary closure of FS1, SQUEEZE DELAY is followed by ADVANCE STOP before BLOCKING occurs.

Air Over Oil Retraction is only available in PROM firmware version 619016-002G (or later) for EN1000 or EN1001 Series Controls.



### 9.5.3 AIR OVER OIL RETRACTION OPERATION – P.O.=07 (cont.)

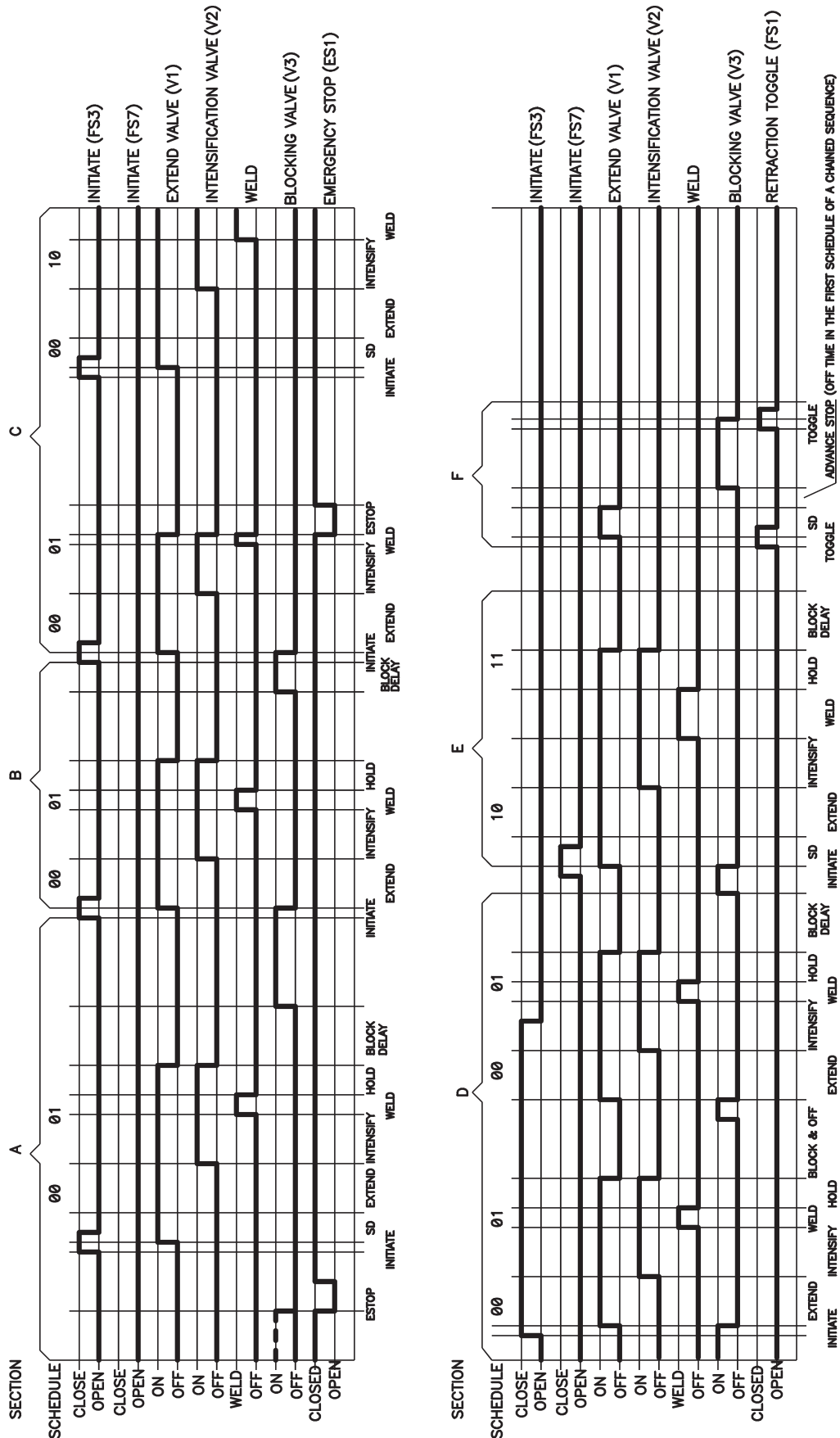


Figure 9-15. Air Over Oil Retraction timing diagrams

## 9.6 MULTIPLE SCHEDULE OPERATION

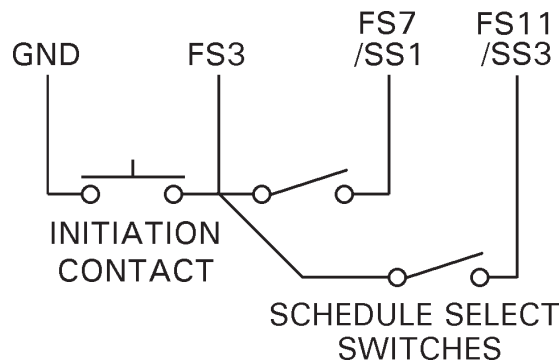
TRIPLE COUNT/TRIPLE CURRENT or 3C/3C can be accomplished on the EN1000/EN1001 Series Controls.

EXTENDED FUNCTION **5.5**. must be set to INTERNAL SCHEDULE SELECT mode (**5.5.=00**). In this mode:

1. A switch closure between TS1-FS3 and TS1-GND will initiate any schedule shown in the SCHEDULE display.
2. A switch closure between TS1-FS7 and TS1-GND will initiate schedule 10.
3. A switch closure between TS1-FS11 and TS1-GND will initiate schedule 20.

Schedule numbers can be externally selected in the EXTERNAL SCHEDULE SELECT mode with use of EXTENDED FUNCTION **5.5.=01**. In this mode:

1. TS1-FS7/SS1 and TS1-FS11/SS3 become binary schedule selects, and can point to one of four schedules – 00, 10, 20, 30.
2. The control is then initiated via TS1-FS3 for any one of the four schedules.



**Figure 9-16. SCHEDULE SELECT**

**Table 9-1. EXTERNAL SCHEDULE SELECT with FS7 and FS11**

SCHEDULE	TS1-FS7/SS1	TS1-FS11/SS3	INITIATION
00	<b>OPEN</b>	<b>OPEN</b>	TS1-FS3
10	<b>CLOSED</b>	<b>OPEN</b>	TS1-FS3
20	<b>OPEN</b>	<b>CLOSED</b>	TS1-FS3
30	<b>CLOSED</b>	<b>CLOSED</b>	TS1-FS3

The control is factory configured for INTERNAL SCHEDULE SELECT mode (**5.5.=00**) or TRIPLE SCHEDULE (3C/3C) operation. See Section 5.4.3 for more information about SCHEDULE SELECT options.

## 9.7 PROCESS OUTPUT 26 HOLD PART IN WELDER IF CURRENT OUT OF LIMIT WINDOW

This PROCESS OUTPUT requires the use of EN1001 Control Board Assembly No. 600572 with PROM firmware version 619016-002C or later. See Section 4.7 for information about Isolation Contactors and Section 8.3.2 for programming HIGH and LOW CURRENT limits.

When **P.O.=26**, the weld control (when wired to the machine as shown in Figure 9-17) will hold the part just previously welded, between the electrodes, if the measured current is not between the programmed HIGH/LOW limit window. The valve assignment must be as follows:

<b>Valve 1</b>	TS1-SV1	Connects to Valve 1 for Electrodes
<b>Valve 2</b>	TS1-SV3	Connects to CR1 which drives Magnetic Isolation Contactor
<b>Valve 3</b>	TS1-SV5	Connects to Alarm Output CR2

### NOTICE

On weld controls with a PROGRAM LOCKOUT key switch, the key must be rotated and error cleared before the part can be removed from the welder.

#### 9.7.1 VALVE 1 (Welding Head Solenoid Output for Electrodes)

Program desired schedule using Valve 1 for SQUEEZE, WELD, and HOLD times (set VALVE MODE=**03**).

### NOTICE

This valve will stay on after the sequence is complete if current is out of programmed HIGH/LO limit window. If current is within limit window, the valve will turn off at end of HOLD.

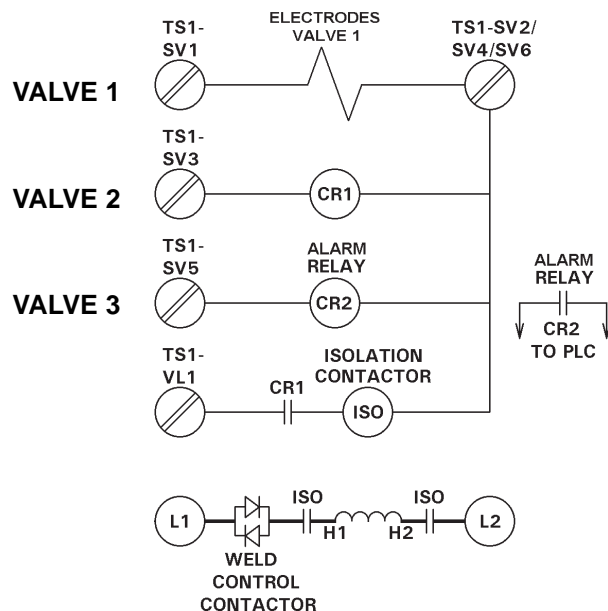


Figure 9-17. PROCESS OUTPUT 26 wiring

### 9.7.2 VALVE 2 (Magnetic Isolation Contactor Output CR1)

This Magnetic Contactor's function is to isolate the Welding Transformer from the control in the possible case that the weld control should malfunction. For example, an SCR could fail shorted during the time the part was being held and maximum current could flow.

Program same desired schedule using Valve 2 for SQUEEZE, WELD, and HOLD times (set VALVE MODE=03). This valve (if programmed) will stay on only during the weld sequence (SQUEEZE, WELD, and HOLD). The Isolation Contactor can be supplied from the factory at time of order. Contact ENTRON for further information.

#### **NOTICE**

Valves 1-3 can only sink 1 amp of current. Check Isolation Contactor current draw. If current is too high, use a Relay (CR1) to buffer the Isolation Contactor as shown in Figure 9-17.

#### **ALSO**

Be certain Valve Transformer or Power Source at VL1 and VL2 can supply sufficient power for Valve 1, Isolation Contactor, and Alarm Relay.

#### **! WARNING !**

**THE ISOLATION CONTACTOR MUST BE CONTROLLED BY VALVE 2 SO THE WELD TRANSFORMER IS ISOLATED FROM THE WELD CONTROL WHEN PART IS HELD IN WELDER.**

IF ISOLATION CONTACTOR IS NOT USED, UNCONTROLLED WELD CURRENT MAY BE APPLIED TO HELD PART.

This is REQUIRED as the Control Relays in the weld control will be held in the ON state until the part is removed or SCRs can fail in shorted condition (see Figure 9-17).

### 9.7.3 VALVE 3 (Alarm Output CR2)

Valve 3 will turn on while part is being held in welder, for currents either over the HIGH limit or below the LOW limit. This output can be used to light a signal lamp or give error indication to a PLC.

When HIGH or LOW ERROR is present, Valve 1 (Welding Head Solenoid Output) and Valve 3 (Alarm Output) will stay on until the error is cleared by pressing any Front Panel button or, on weld controls with a Program Lockout key switch, the key must be rotated and the error cleared before the part can be removed from the welder. Valve 2 (Magnetic Isolation Contactor Output) will turn off at the end of HOLD time, removing power from the Weld Transformer. When the error is cleared, all valve outputs will turn off and the control will go through a Power On Reset.

## 9.8 HALF CYCLE CURRENT MONITORING

The EN1001 Series Controls may be used to weld using half of a cycle.

### 9.8.1 ENABLE HALF CYCLE WELDING

1. Put the control in PROGRAM mode.
2. Use the SELECT push button to find **EF**.
3. Use the SCHEDULE push buttons to find **P.O.** in EXTENDED FUNCTIONS.
4. Program **P.O.=09** to enable HALF CYCLE welding.
5. Make sure the value for EXTENDED FUNCTION **S.E.=00**.

### 9.8.2 PROGRAM A HALF CYCLE WELD

1. Use the SCHEDULE push buttons to select a working schedule.
2. Program SQUEEZE to meet the cylinder squeeze requirements.
3. Program WELD=**01**.
4. Program HOLD to meet the weld schedule requirements.
5. Program OFF=**00** (HALF CYCLE is not possible in REPEAT schedules).
6. Program IMPULSES=**00** (Many unidirectional HALF CYCLE IMPULSES induce saturation/half cycling).
7. Program COOL=**00**.
8. Program VALVE MODE to meet requirements of the machine.
9. Program CYCLE MODE=**00** (NON-REPEAT and non-CHAINED schedule).
10. Program SLOPE MODE=**00**.
11. Program SLOPE COUNT=**00**.

### 9.8.3 ENABLE CURRENT MONITORING

1. Use the SELECT push buttons and find **EF**.
2. Use the SCHEDULE push buttons to find **C.r.** in EXTENDED FUNCTIONS.
3. Program **C.r.=11, 31, or 33**, depending on the type of sensor used.
4. Program **r.A.** to proper range (see appropriate instructions in Section 5.4.16).
5. Use the SELECT push button to select PERCENT CURRENT.
6. Re-assert/update the programmed value by pressing ENTER or program the necessary PERCENT CURRENT in the DATA display.
7. Put the control in OPERATE mode.
8. Make a weld. If necessary, adjust the CURRENT (repeat Steps 6, 7, and 8).
9. After the weld, the control will display a value of CURRENT.
10. Put the control in PROGRAM mode.
11. While in PERCENT CURRENT function, use the SCHEDULE push buttons to find **H. i.** and **L.o.** parameters.
12. Program the appropriate value of HIGH and LOW limits if necessary. If these values are left at **00**, control will use a limit of +10% for HIGH limit and -10% for LOW limit.

#### NOTICE

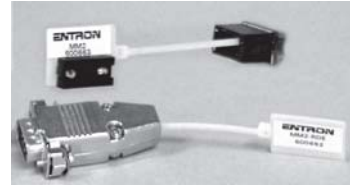
If FUNCTION indicator LEDs are set to display PERCENT CURRENT, the control will show measured CURRENT after every weld. If the weld CURRENT is too low or too high, the weld control will block further initiations. The Valve 3 output (410319 Firing Boards) will turn on immediately upon a HIGH or LOW ERROR condition and remain on until the Front Panel push buttons are used to acknowledge the error.

## 10.0 OPTIONS ON EN1000 AND EN1001 SERIES CONTROLS

The following optional devices can be used with EN1000 or EN1001. Consult factory or sales representatives for details. Not all options are available in all Cabinet Styles.

### 10.1 MM2 MEMORY MODULE

The MM2 Memory Module is designed as a backup device for any EN1000/EN1001 Series Control. There are two versions of this device: **MM2-RDE** for controls with RDE option and **MM2** for all other controls. The only difference between these two versions is the connection to control. The MM2-RDE is designed to plug into 9 pin D-Subminiature connector; the MM2 is designed to plug directly into J4 connector on Control Board. See Instruction Manual 700202 for additional information.



### 10.2 INTEGRATED PRESSURE SENSE & CONTROL SYSTEM (IPSC)

See Instruction Manual 700178 for further details regarding the options for IPSC System.

#### PRESSURE SENSOR

The Pressure Sensor accurately measures air pressure and converts measurement to an electrical signal. The electrical output is a linear ratio of the sensed pressure. The Sensor is connected to the IPSC or IPS board through TS13. The signal from the Sensor is converted by IPSC or IPS Board and data is sent to the weld Control Board.



The pressure may be displayed by the weld control if EXTENDED FUNCTION parameter **5.1** is selected. The pressure reading depends on the location of the Sensor.

#### PRESSURE CONTROL

The Integrated Pressure Sense Control System is designed for any application that requires automatic selection of a pre-programmed pressure, or automatic switching between different pressure settings. Weld control schedules may be chained to obtain sequential pressure changes. The benefits of the system depend on the application. The ENTRON IPSC or IPC System allows for sequencing of multiple pressures with one initiation. The flexibility of operation is only limited by the number of weld schedules. An IPSC or IPC System may be used to remove the worry of pressure settings from the operator. Also, the IPSC or IPC System may be used to reduce electrode wear by programming “soft set-down” during SQUEEZE. The IPSC or IPC System may eliminate multiple valves to simplify forging operations. Another application may serve to eliminate many valves when multiple pressures are required for selecting different pressure regulators.



#### 4-20 mA CONTROL AND/OR SENSE

The IPSC, IPS or IPC Board could be used for any 4-20 mA sensor input or 4-20 mA for regulated output for different applications. For example, the IPS Board can be successfully used for the welding parts detection.

## 10.0 OPTIONS ON EN1000/EN1001 SERIES CONTROLS (cont.)

### 10.3 24 VDC VALVE OUTPUTS

Optional Terminal Strip/Firing Board A/N 410319 with 24 VDC output. See Application Note 700189 for additional information.



### 10.4 CURRENT SENSORS

Primary Coil and Secondary Rogowski Coils (6" and 10") are available for Constant Current operation on EN1001 Series Controls. See Section 8.0 for further details.



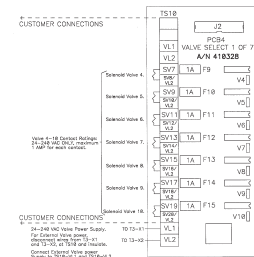
### 10.5 PROGRAM LOCKOUT KEY SWITCH

A PROGRAM LOCKOUT key switch prohibits unauthorized editing of control parameters. It can be ordered as a factory installed option or ordered separately and field installed by the customer. See Section 2.1 for more details.



### 10.6 1 OF 7 VALVE EXTENSION BOARD

With this option, the three standard binary valves are decoded to one of seven valves, providing an additional 7 valve output circuits. See Application Note 700110 for further details.



### 10.7 SCHEDULE SELECT S49 OPTION

The S49 Option adds six binary select inputs to the EN1000/EN1001 Series Controls. Through the use of these added inputs, the user can select any one of 49 schedules to begin a sequence. This option is typically tied to a PLC or PC that selects the required schedule. Section 5.4.3 and Application Note 700182 provides additional details.



### 10.8 RS485 OPTIONS

Controls with RS485 Option can communicate with Remote Terminal RT4jr. or PC or other devices with RS485 interface, over two-wire RS485 network (ENBUS network). Enables use of ENLINK 1000/1001 Software. Instruction Manual 700171 further explains this option.

The non-proprietary ENBUS protocol defines a message format that controls will recognize and use, regardless of who is the host – either RT4 or other devices. It describes the process which a host uses to request access to different controls, how the host will respond to request from the controls, and how errors will be detected and reported. This protocol provides an internal standard which hosts and controls use for parsing messages.

During communication on a ENBUS network, the protocol determines how each host and control will know its address (Identification Number), recognize a message addressed to it, determine which action will be taken, and extract any data or other information contained in the message.





## 11.0 ERROR CODES AND TROUBLESHOOTING

Please refer to other manual pages and Wiring Diagrams for location of fuses, terminal strips, etc.

### 11.1 ERROR CODES

ERROR	POSSIBLE CAUSE	REMEDY
Data/Schedule Display <b>E.r.=01</b>	Error Code #01 Temperature Limit Switch open or overheated.	Wait for the Temperature Limit Switch to cool or check for open circuit. <b>See Section 4.3, 4.5, and 5.4.6.</b>
Data/Schedule Display <b>E.r.=02</b>	Error Code #02 FS1 AND FS7 both closed.	Two Stage Operation not allowed with FS7. <b>See Section 4.3 and 4.4.</b>
Data/Schedule Display <b>E.r.=03</b>	Error Code #03 FS1 AND FS11 both closed.	Two Stage Operation not allowed with FS11. <b>See Section 4.3 and 4.4.</b>
Data/Schedule Display <b>E.r.=04</b>	Error Code #04 Attempt to weld in PROGRAM mode.	Return to OPERATE mode. <b>See Section 2.1 and 6.0.</b>
Data/Schedule Display <b>E.r.=05</b>	Error Code #05 FS1,FS3,FS7,FS11 closed to GND before power on or before Emergency Stop is re-closed after being opened.	Initiations must be open at power on or after an Emergency Stop. <b>See Section 1.1, 4.3, and 4.4.</b>
Data/Schedule Display <b>E.r.=06</b>	Error Code #06 Back-step or Retraction is closed too long or at start of sequence.	Open TS1-TLS1/AUX1. <b>See Section 4.3, 4.5, and 5.4.6.</b>
Data/Schedule Display <b>E.r.=07</b>	Error Code #07 FS1 initiated while another seq. active.	Open TS1-FS1. <b>See Section 4.3, 4.5, 5.4.3, and 9.6.</b>
Data/Schedule Display <b>E.r.=08</b>	Error Code #08 FS3 initiated while another seq. active.	Open TS1-FS3. <b>See Section 4.3, 4.5, 5.4.3, and 9.6.</b>
Data/Schedule Display <b>E.r.=09</b>	Error Code #09 FS7 initiated while another seq. active.	Open TS1-FS7. <b>See Section 4.3, 4.5, 5.4.3, and 9.6.</b>
Data/Schedule Display <b>E.r.=10</b>	Error Code #10 FS11 initiated while another seq. active.	Open TS1-FS11. <b>See Section 4.3, 4.5, 5.4.3, and 9.6.</b>
Data/Schedule Display <b>E.r.=11</b>	Error Code #11 Control Board. Control Relay problem.	Replace Control Board.
Data/Schedule Display <b>E.r.=12</b>	Error Code #12 Control Board. Hardware error.	Replace Control Board.
Data/Schedule Display <b>E.r.=13</b>	Error Code #13 Full conduction detected.	Change to higher welding transformer tap. <b>See Section 5.4.10.</b>

## 11.1 ERROR CODES (cont.)

ERROR	POSSIBLE CAUSE	REMEDY
Data/Schedule Display <b>E.r.=14</b> (Flashing)	Error Code #14 EEPROM error. Memory corrupt due to electrical transients.	1. Clear all SCHEDULES and EXTENDED FUNCTIONS. 2. Re-route wiring in cabinet. Replace Control Board, if necessary. <b>See Section 4.6, 5.4.5.</b>
Data/Schedule Display <b>E.r.=15</b>	Error Code #15 Pressure Switch open too long.	1. Close Pressure Switch 2. Check wiring for open. <b>See Section 1.1, 4.3, and 4.5.</b>
Data/Schedule Display <b>E.r.=17</b> or <b>E.r.=18</b>	Error Code #17 or 18 Nominal AVC reading too low or too high.	1. Reprogram nominal setting. 2. Check <b>C.L.</b> value. <b>See Section 5.4.4.</b>
Data/Schedule Display <b>E.r.=19</b> or <b>E.r.=20</b>	Error Code #19 or 20 AVC reading too low or too high.	1. AVC could not compensate. 2. Change tap or PERCENT. <b>See Section 5.4.4.</b>
Data/Schedule Display <b>E.r.=22</b>	Error Code #22 +18 VDC out of range. High line voltage.	1. Line voltage too high. 2. Wrong voltage jumper settings. <b>See Section 4.1.</b>
Data/Schedule Display <b>E.r.=23</b> or <b>E.r.=24</b>	Error Code #23 or 24 Manual Power Factor error.	1. Full conduction reached. 2. Set Automatic Power Factor. <b>See Section 5.4.10.</b>
Data/Schedule Display <b>E.r.=26</b>	Error Code #26 SCR Contactor short detected.	1. Check Contactor for short. 2. Check Firing Board.
Data/Schedule Display <b>E.r.=27</b>	Error Code #27 Retraction valve is not ON.	Turn ON retraction valve via TS1-TLS1/AUX1. <b>See Section 4.5, 5.4.7.</b>
Data/Schedule Display <b>E.r.=28</b>	Error Code #28 PROCESS OUTPUT <b>IO</b> error.	Attempting to weld in NO WELD with <b>P.O.=10</b> . <b>See Section 5.4.7.</b>
Data/Schedule Display <b>E.r.=32</b> (Flashing)	Error Code # 32 Invalid data in EEPROM.	Clear SCHEDULE with corrupted data or clear EXTENDED FUNCTIONS. See <b>E.r.=14</b> remedy. <b>See Section 4.6, 5.4.5.</b>
Data/Schedule Display <b>E.r.=37</b> ( <i>EN1001 only</i> )	Error Code # 37 Calibration data out of range.	1. Change to Auto-Range mode. 2. Run in Preset-Range w/o correct RMS current values. 3. Return Control Board to factory for re-calibration.

For list of all Error Codes, refer to Appendix A (Application Note 700158).

## 11.2 TROUBLESHOOTING

Please refer to other manual pages and Wiring Diagrams for location of fuses, terminal strips, etc.

It is very easy to press a SCHEDULE push button and select a different schedule accidentally. This causes no problem when initiating on FS7 or FS11. However, when initiating on FS3, always verify that the schedule to be initiated is displayed prior to initiation. Conversely when the default setting of **5.5.=00** is used, FS7 and FS11 will select schedule 10 and 20 respectively. The control may display any schedule at any time. Foot switch (FS) connections and EXTENDED FUNCTION **5.5.** determine which schedule will be executed. Use care when programming to be sure operating parameters are stored in the schedule to be initiated.

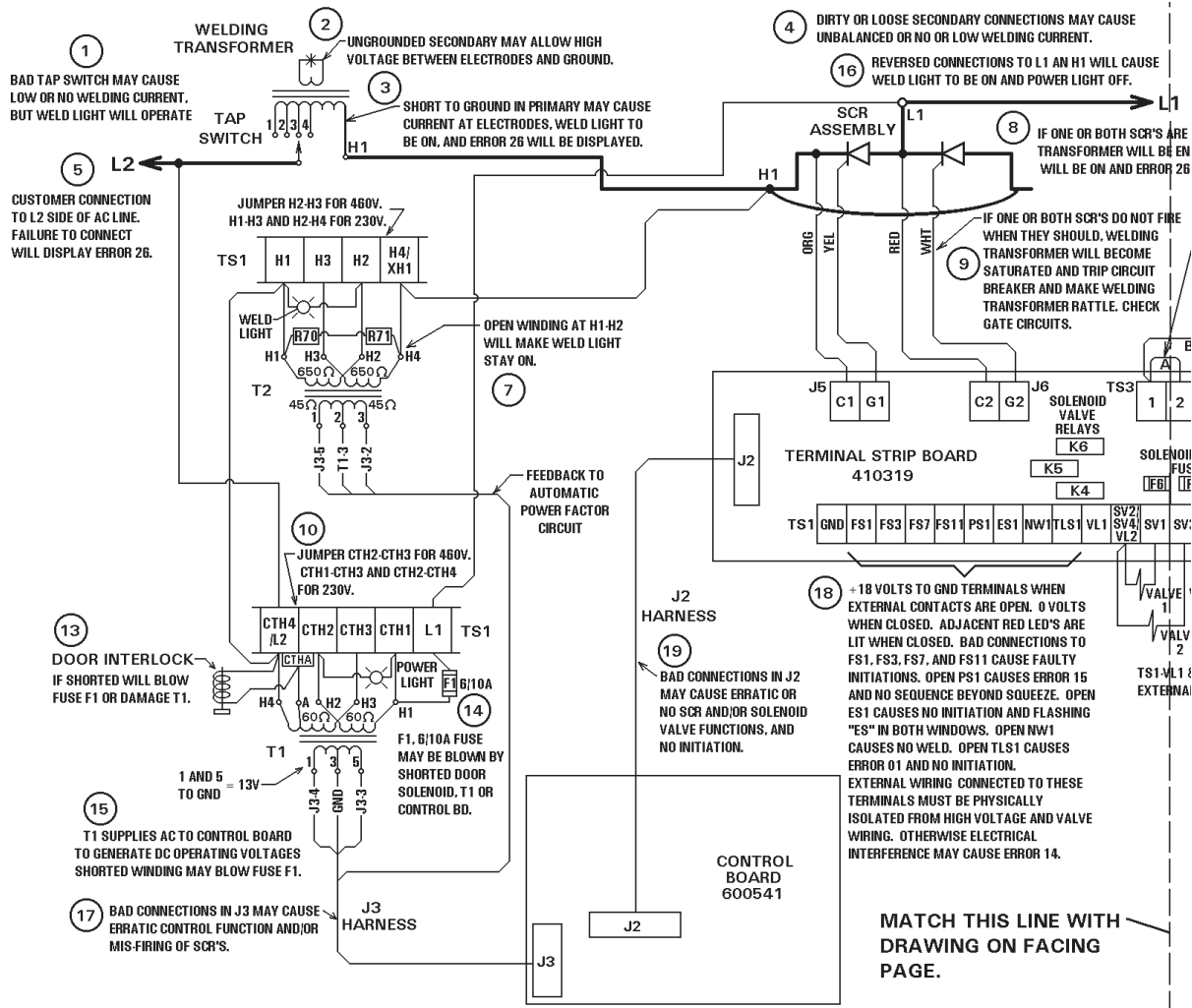
TROUBLE	POSSIBLE CAUSE	REMEDY
Power Switch ON but no display.	<ol style="list-style-type: none"> <li>1. Fuse F1 control fuse blown.</li> <li>2. Defective Circuit Breaker.</li> <li>3. Defective Control Board.</li> </ol>	<ol style="list-style-type: none"> <li>1. Check that control is being powered by all phases.</li> <li>2. Replace Circuit Breaker.</li> <li>3. Replace Control Board.</li> </ol>
Control will not initiate.	<ol style="list-style-type: none"> <li>1. Initiation switch(es) defective.</li> <li>2. Loose or broken wire(s) at initiation switch(es).</li> <li>3. Fuses F6 - F8 valve fuses blown.</li> <li>4. Defective Control/Display or Terminal Strip/Firing PCB.</li> </ol>	<ol style="list-style-type: none"> <li>1. Replace switch(es).</li> <li>2. Check for loose or broken wire(s) at initiation switch(es) and at Terminal Strip (FS1, FS2, etc.).</li> <li>3. Check valve solenoid coil.</li> <li>4. Replace board with another board stamped with same A/N.</li> </ol>
Control initiates, valve light comes on, but electrodes <i>do not</i> close.	<ol style="list-style-type: none"> <li>1. Solenoid valve circuit mis-wired or broken wires.</li> <li>2. Hydraulic (or air) line blocked.</li> </ol>	<ol style="list-style-type: none"> <li>1. Check terminals VL1, SV1 and SV2, and associated wiring (see Wiring Diagram).</li> <li>2a) Check pressure.</li> <li>2b) Repair or replace air accessories.</li> </ol>
Control does not initiate, but welder head or arms close.	<ol style="list-style-type: none"> <li>1. Mis-wired for Single Stage operation.</li> <li>2. Second Stage Pilot switch open.</li> <li>3. Defective Control/Display or Terminal Strip/Firing PCB.</li> </ol>	<ol style="list-style-type: none"> <li>1. Check Pilot switch wiring.</li> <li>2. Check for proper operation of Pilot switch. Be sure First Stage closes before Second Stage.</li> <li>3. Replace board with another board stamped with same A/N.</li> </ol>
Control initiates, but stays in SQUEEZE.	<ol style="list-style-type: none"> <li>1. Pressure Switch not closing.</li> <li>2. Defective Control/Display or Terminal Strip/Firing PCB.</li> </ol>	<ol style="list-style-type: none"> <li>1a) Check for defective or malfunctioning Pressure Switch connected to PS1 &amp; GND.</li> <li>1b) If no Pressure Switch is used, jumper PS1 &amp; GND.</li> <li>2. Replace board with another board stamped with same A/N.</li> </ol>

## 11.2 TROUBLESHOOTING (cont.)

TROUBLE	POSSIBLE CAUSE	REMEDY
Control initiates and sequences properly, but solenoid valve chatters.	<ol style="list-style-type: none"> <li>1. Solenoid valve coil.</li> <li>2. Defective Control/Display PCB.</li> <li>3. Defective Terminal Strip/Firing Board.</li> </ol>	<ol style="list-style-type: none"> <li>1a) Check that valve supply voltage is not varying below tolerance, -15%.</li> <li>1b) Check if valve coil is proper voltage.</li> <li>1c) Insufficient air pressure.</li> <li>1d) Loose connections in valve wiring.</li> </ol> <ol style="list-style-type: none"> <li>2. Replace board with another board stamped with same A/N.</li> <li>3. Replace board. See Wiring Diagram for correct A/N.</li> </ol>
Control sequences but will not weld.	<ol style="list-style-type: none"> <li>1. External Weld/No Weld Switch or WELD/NO WELD switch on Front Panel of control.</li> <li>2. Welding transformer not connected.</li> <li>3. Welding transformer secondary open.</li> <li>4. Defective Terminal Strip/Firing PCB.</li> <li>5. Defective Control/Display PCB.</li> <li>6. Excessive ripple in secondary.</li> </ol>	<ol style="list-style-type: none"> <li>1a) Check both for proper operation and/or loose wires on NW1 &amp; GND.</li> <li>1b) If no external Weld/No Weld Switch is used, put jumper across NW1 &amp; GND.</li> </ol> <ol style="list-style-type: none"> <li>2. Connect H1 and H2 to lugs in the control.</li> <li>3. Check corroded or open connections. Be sure welding electrodes close on work.</li> <li>4. Replace board. See Wiring Diagram for correct A/N.</li> <li>5. Replace board with another board stamped with same A/N.</li> <li>6. Check for missing phase.</li> </ol>
Weld too cool.	<ol style="list-style-type: none"> <li>1. Line voltage drop.</li> <li>2. Excessive pressure at electrodes.</li> <li>3. WELD count too short.</li> <li>4. Excessive tip “mushrooming”.</li> </ol>	<ol style="list-style-type: none"> <li>1. KVA demand for welding transformer too high for input power line. Check line voltage.</li> <li>2. Check air system regulator.</li> <li>3. Increase WELD count duration.</li> <li>4. Properly dress tips.</li> </ol>
Weld too small.	<ol style="list-style-type: none"> <li>1. PERCENT CURRENT too low.</li> <li>2. Electrode face too small.</li> </ol>	<ol style="list-style-type: none"> <li>1. Increase PERCENT CURRENT.</li> <li>2. Select correct electrode face diameter.</li> </ol>
“HOT” Welds	<ol style="list-style-type: none"> <li>1. Insufficient air pressure.</li> <li>2. WELD count set too high.</li> <li>3. PERCENT CURRENT set too high.</li> <li>4. Electrode diameter too small.</li> </ol>	<ol style="list-style-type: none"> <li>1. Check air supply and accessories.</li> <li>2. Reduce WELD count duration.</li> <li>3. Decrease PERCENT CURRENT.</li> <li>4. Dress or replace tip with proper size.</li> </ol>
Inconsistent Welds	<ol style="list-style-type: none"> <li>1. Varying air pressure.</li> <li>2. Work not square with electrodes.</li> <li>3. Poor part fit-up.</li> <li>4. Dirty material to be welded.</li> <li>5. Loose connection.</li> </ol>	<ol style="list-style-type: none"> <li>1. Check air supply and accessories.</li> <li>2. Check welding fixtures setup or electrode alignment.</li> <li>3. Check parts for proper fit-up.</li> <li>4. Work should be free from excessive dirt, paint and oxides.</li> <li>5. Check all terminal and/or lug connections inside the cabinet.</li> </ol>

THIS PAGE IS  
INTENTIONALLY  
BLANK

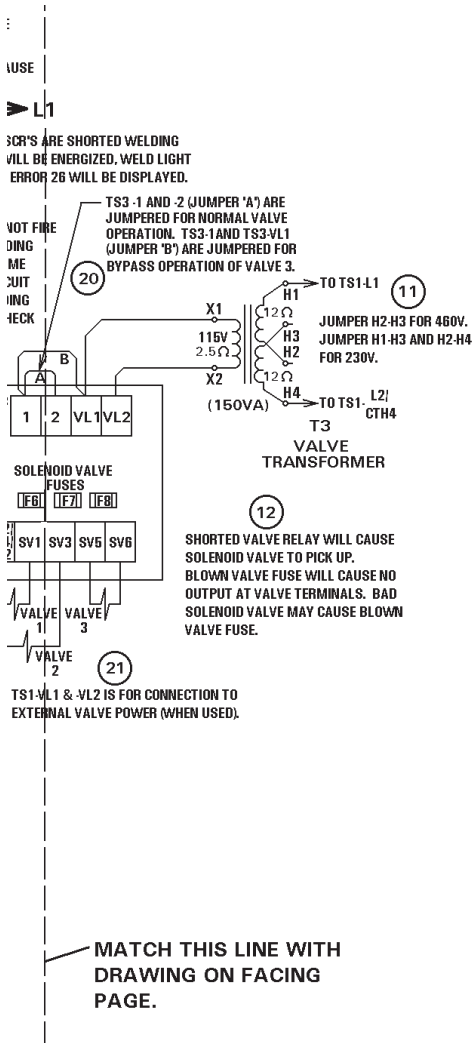
# 11.3 TROUBLESHOOTING GUIDE



**NOTICE**

Drawing not typical of Style "C" Cabinet fusing.

# 11.3 TROUBLESHOOTING GUIDE (cont.)

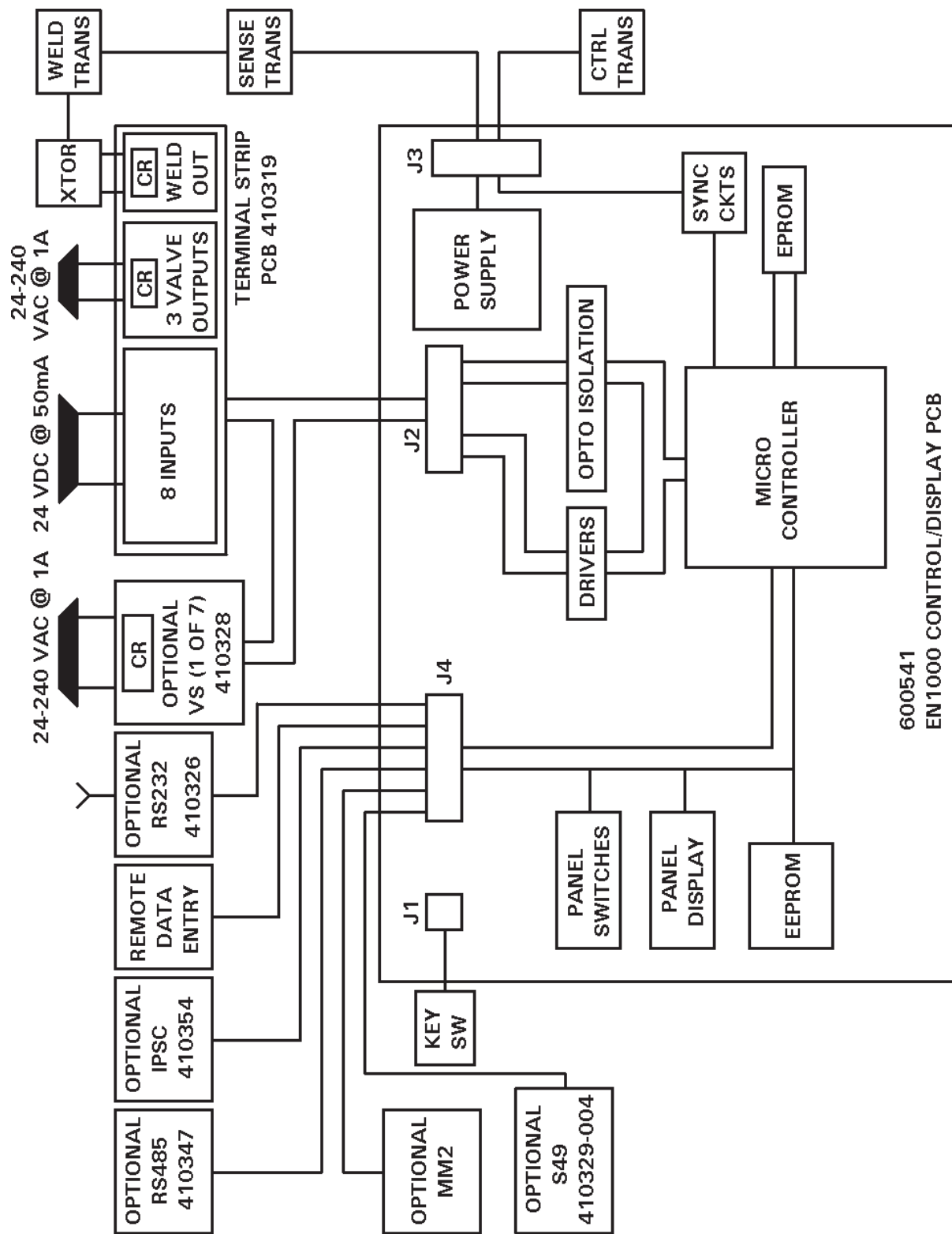


TROUBLE SYMPTOM	SEE NOTE #
A. Power Light Off	14
B. Power Light Off, Weld Light On	16
C. Weld Light On	8, 3, 7
D. One or more Solenoid Valves Energized	12
E. Blowing fuse F1	10, 13, 14, 15
F. No Initiation	18, 19
G. Control goes through sequence but electrodes do not close.	11, 12, 19
H. Control and machine go through sequence but there is no current and Weld Light does not come on.	18, 19
J. Control and machine go through sequence but there is no weld current. Weld light comes on.	1, 4
K. Blowing Valve Fuses	12
L. Tripping Circuit Breaker	9, 17, 19
M. High Voltage between Welding Electrodes and Ground.	2
N. Welding Current occasionally drops to a low level.	1, 4
P. Erratic Sequence or Valve operation	17, 19
R. Sequence will not advance beyond Squeeze. (Electrodes remain closed, no Weld Current)	18
S. Error 26 displayed immediately when power is turned on.	3, 5, 8
T. Error 14 displayed on Front Panel.	18
U. Jumper A on TS3-1 to -2. Provides normal operation of Valve 3. Jumper B provides bypass operation of Valve 3, some EF's and PO's will not work without Jumper B in place.	20
V. When external valve power source (24-240 VAC) is used it connects here. Remove and insulate connections to TS3-VL1 and -VL2.	21

## TROUBLE SHOOTING GUIDE EN1000-SERIES CONTROLS

451014 A

# 11.4 WELD CONTROL WITH OPTIONS BLOCK DIAGRAM





## 12.0 ENTRON LIMITED WARRANTY AND FACTORY SERVICE

ENTRON Controls, LLC., warrants that all ENTRON control panels, **EXCEPT** Mid-frequency Inverter controls, silicon controlled rectifiers (SCRs), SCR and IGBT assemblies, circuit breakers, and electro-mechanical contactors, are free of defects for a period of **TWO YEARS** from the date of original purchase and, in the event of a manufacturing defect, ENTRON will repair or replace, at its discretion, the defective part without any cost for parts or labor.

All silicon controlled rectifiers, SCR and IGBT assemblies, and circuit breakers in ENTRON control panels are covered by a limited warranty from the original manufacturer (other than ENTRON). If these parts fail because of a manufacturing defect, they will not be repaired or replaced by ENTRON, but will be returned by ENTRON to the original manufacturer in accordance with said manufacturer's warranty.

ENTRON Controls, LLC., warrants that all Mid-frequency Inverter controls are free of defects for a period of **ONE YEAR** from the date of original purchase and, in the event of a manufacturing defect, ENTRON will repair or replace, at its discretion, the defective part without any cost for parts or labor.

To obtain repairs or replacement parts under this warranty, the defective parts must be returned, prepaid, to ENTRON Controls, LLC., 601 High Tech Court, Greer, SC 29650. Please send your repair to the attention of "service" with a description of the problem you are experiencing, contact person and phone number.

**EXCLUSIONS: This warranty does not cover damage by accident, misuse, unauthorized repair or modification to any control assembly by the customer.**

**IMPORTANT NOTE: The warranty period is considered from the date of shipment and is tracked by a serial number code.**

### **USE OF "OUT OF WARRANTY" REPAIR SERVICE:**

To obtain service for any printed circuit board assembly or welding control after the warranty period, send the assembly or control, prepaid, to ENTRON Controls, LLC., and ENTRON will repair the printed circuit board assembly or control and return it to you without further warranty on its part. Additional service charges will be invoiced at time of shipment.

**Your ENTRON Controls, LLC., Original Equipment Manufacturers (OEMs), Dealers and Distributors are your first response contact to secure technical assistance on control or welding problems. Should they be unable to assist you, please contact your ENTRON sales representative or the factory directly. Contact the factory at 864-416-0190.**

# APPENDIX A – ERROR CODES

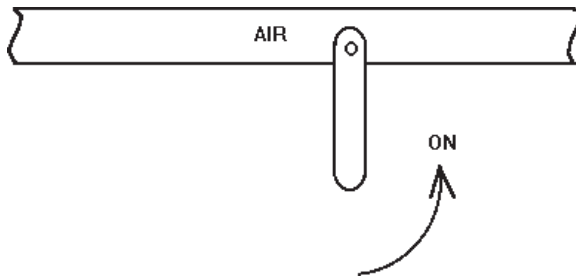
## APPLICATION NOTE 700158K ERROR CODES\*

ERROR CODE	Reason or Cause
01	Temperature limit exceeded (TLS open). / Incorrect <b>b.5.</b> or <b>P.O.</b> programmed.
02	FS1 & FS7 are both active.
03	FS1 & FS11 are both active.
04	Weld initiated while in PROGRAM mode.
05	FS1, FS3, FS7, or FS11 is active upon power up.
06	BACK-STEP is active too long. / Input switch closed. / Incorrect <b>b.5.</b> or <b>P.O.</b> programmed.
07	FS1 still active after weld.
08	FS3 still active after weld.
09	FS7 still active after weld.
10	FS11 still active after weld.
11	Control Relay still active after weld.
12	Hardware error is detected.
13	Full conduction is detected.
14	EEPROM error is detected (see Section 4.6 or refer to Application Note 700127).
14 - flashing	Invalid data in EEPROM (see Section 4.6 or refer to Application Note 700127).
15	Pressure Switch is open too long.
16	Emergency Stop is active.
17	Nominal AVC reading is too low.
18	Nominal AVC reading is too high.
19	AVC reading is too low.
20	AVC reading is too high.
21	+5 VDC is out of range.
22	+18 VDC is out of range.
23	Maximum firing angle exceeded during AVC correction.
24	Minimum firing angle exceeded during AVC correction.
25	Power factor measured as zero.
26	Sense input active while not welding. / Shorted SCRs. / Incorrect wiring or missing L2.
27	Retraction not active upon initiation.
28	Front Panel NO WELD switch is active for <b>P.O.=10</b> or for <i>EN1000/EN1001 Cascade only</i> <b>P.O.=33</b> .
29	Schedule out of range for <b>S.5.=03</b> when using S49 or S99 option.
30	Over current ( <i>EN1200 and EN1201 only</i> ).
31	IIC Error.
32 - flashing	Invalid data in EEPROM (see Section 4.6 or refer to Application Note 700127).
33	MM2 is not found. Memory Module required.
34	Downloading data from MM2 Checksum Error.
35	Copy data to MM2 Checksum Error.
36	Pressure Sense input is too low or too high.
37	Calibration data out of range ( <i>EN1001 only</i> ).
38	DC bus voltage is too low ( <i>EN1200 and EN1201 only</i> ).
39	DC bus voltage is too high ( <i>EN1200 and EN1201 only</i> ).
40	Control with programmed ID not found on the RS485 network ( <i>RT4 only</i> ).
41	Message is not received from the control ( <i>RT4 only</i> ).
42	Communication Error ( <i>RT4 only</i> ).
43	Checksum Error in data bytes ( <i>RT4 only</i> ).
44	DC bus voltage is too high. Send signal to Circuit Breaker Shunt Trip. ( <i>EN1200 and EN1201 only</i> ).
45	One or two of the three phases are missing ( <i>EN1200 and EN1201 only</i> ).
46	Setup failed. Control failed to adjust for signal level ( <i>EN1001/EN1001 Cascade</i> ).
47	Over current from Primary Current Sensor ( <i>EN1200 and EN1201 only</i> ).
48	SCR's Firing Board is not ready for weld ( <i>EN1200 and EN1201 only</i> ).
90	Error Output from control to ENLINK, High.
91	Error Output from control to ENLINK, Low.
d.o.u.n.	VCC power supply voltage below safe operating range (see Section 1.1).
H. i. or L. o.	Flashing on DATA display if control is unable to correct and maintain constant current during weld. Generally shown after weld for <b>P.O.=12, 13, 14, 22, 23, 24</b> or <b>25</b> ( <i>EN1001 and EN1201 only</i> ).
E.5. - flashing	Emergency Stop is active (see Section 1.1).

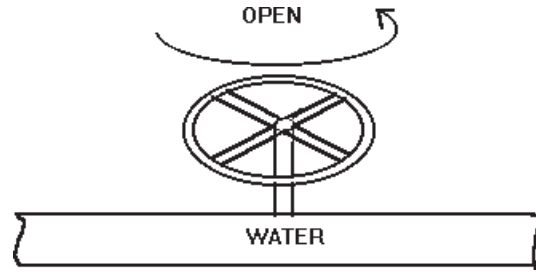
\*These ERROR CODES affect controls in Series EN1000, EN1001, EN1000B, EN1003, EN1000/EN1001 Cascade, EN1200, EN1201, EN1280, TW1280, EN1380, EN1500 and EN1501.

# APPENDIX B PROGRAMMING AND SETUP

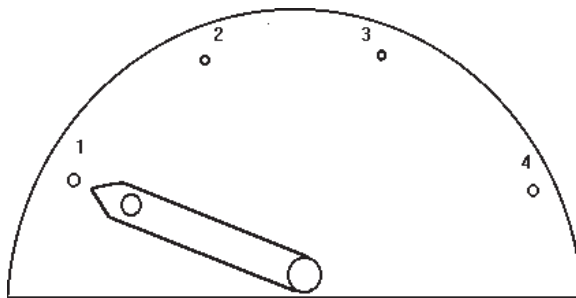
## B-1.0 INTRODUCTION TO PROGRAMMING EN1000/EN1001 SERIES CONTROLS



**Figure B-1.** Turn ON air supply to machine

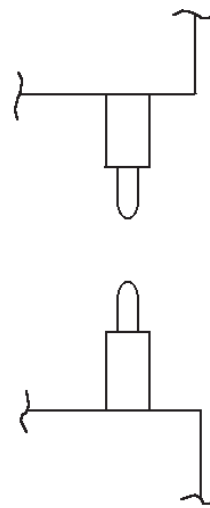


**Figure B-2.** Turn ON water supply to machine



**Figure B-3.** Set welder switch LOW

Be sure welder head or arms are fully retracted!

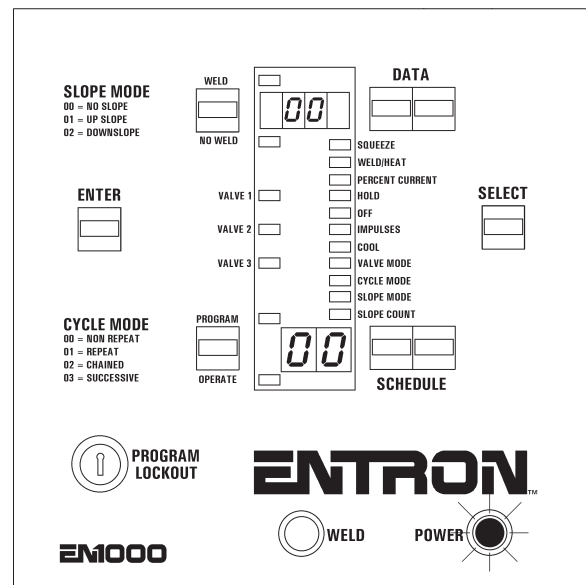


BE SURE WELDING HEADS ARE FULLY RETRACTED

**Figure B-4.** Retracted head or arms



**Figure B-5.** Turn ON power to control



**Figure B-6.** POWER ON light indicator

# APPENDIX B PROGRAMMING AND SETUP (cont.)

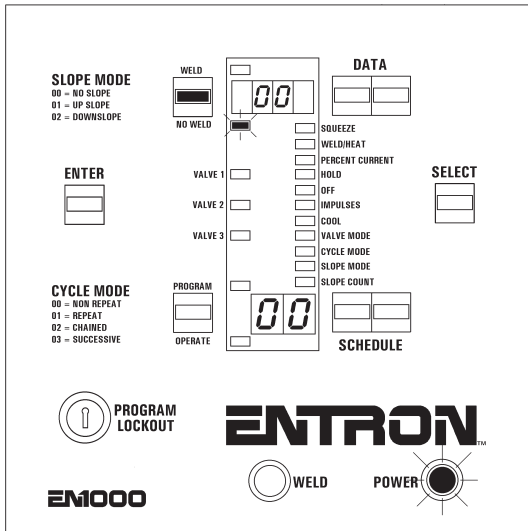


Figure B-7. Put control in NO WELD

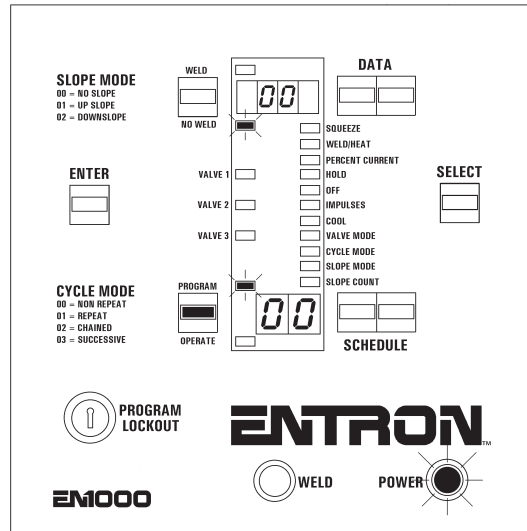


Figure B-8. Put control in PROGRAM mode

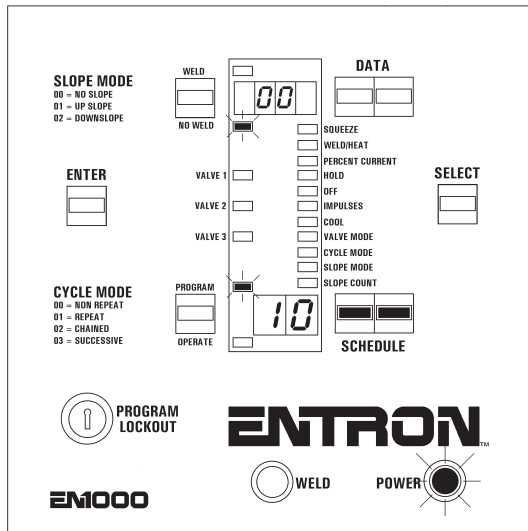


Figure B-9. Choose SCHEDULE to program

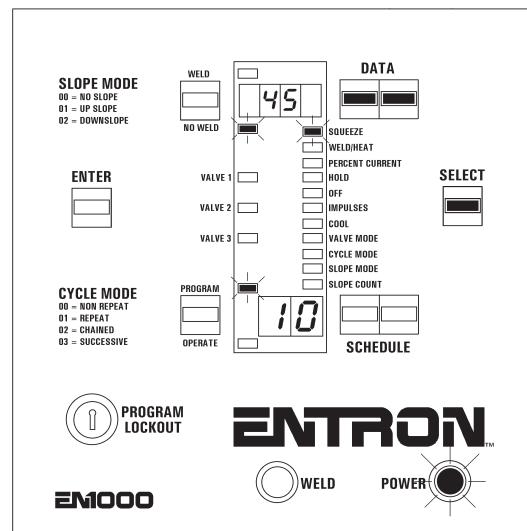


Figure B-10. SELECT SQUEEZE and program 30 to 60 cycles

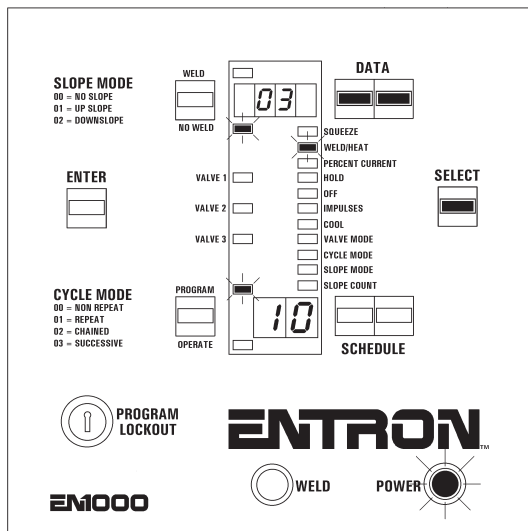


Figure B-11. SELECT WELD/HEAT and program 2 to 3 cycles

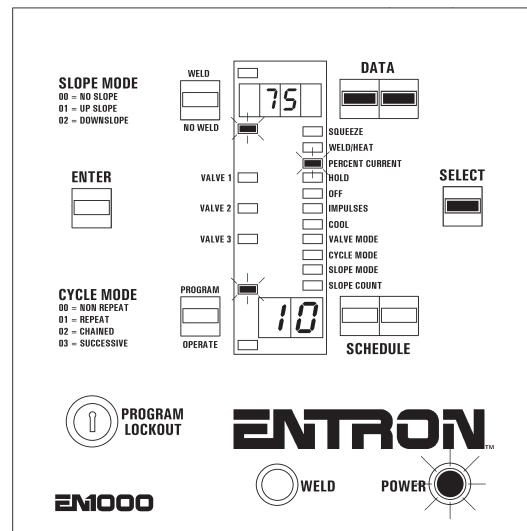
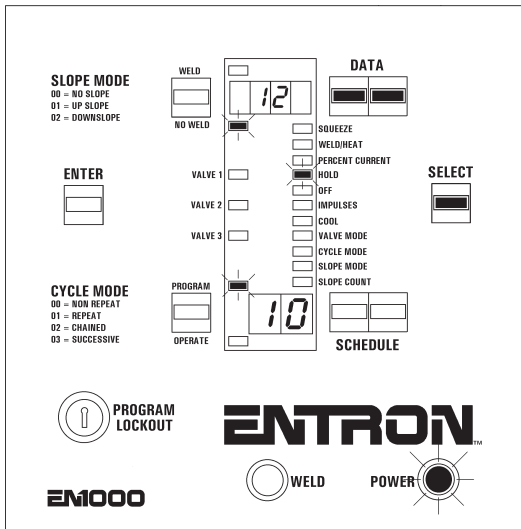
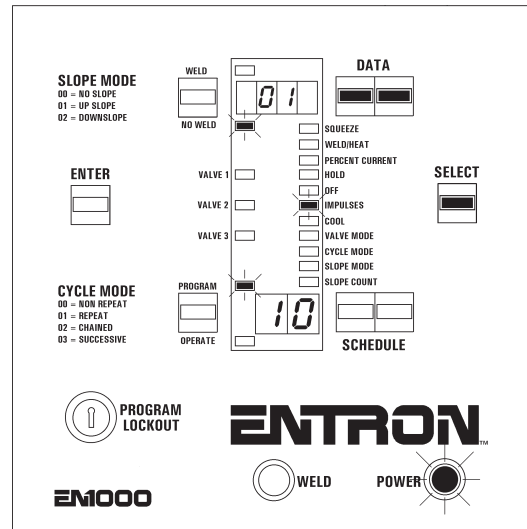


Figure B-12. SELECT PERCENT CURRENT and program 70% to 80%

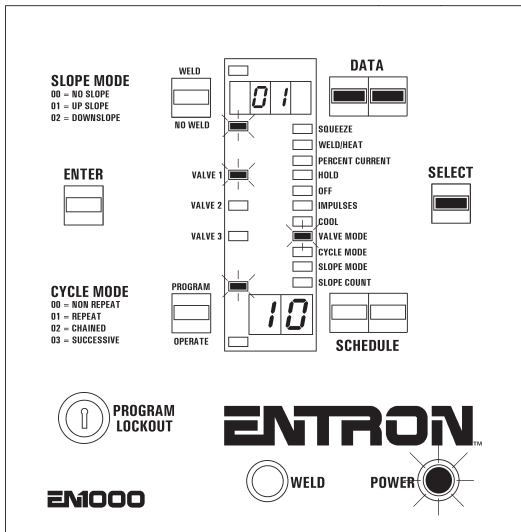
# APPENDIX B PROGRAMMING AND SETUP (cont.)



**Figure B-13.** SELECT HOLD and program 10 to 15 cycles



**Figure B-14.** SELECT IMPULSES and program 01 (one pulse)

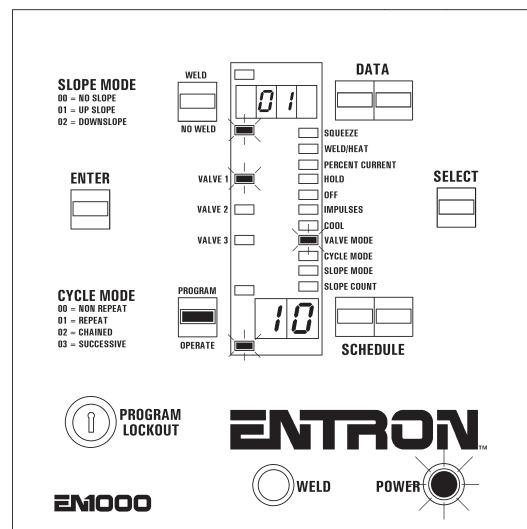


**Figure B-15.** SELECT VALVE MODE and program 01 (Valve 1)

Press ENTER whenever new values for any parameter are programmed.

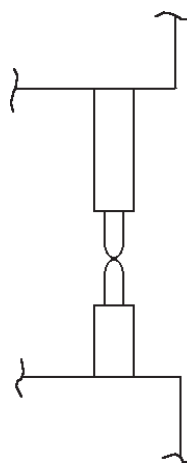
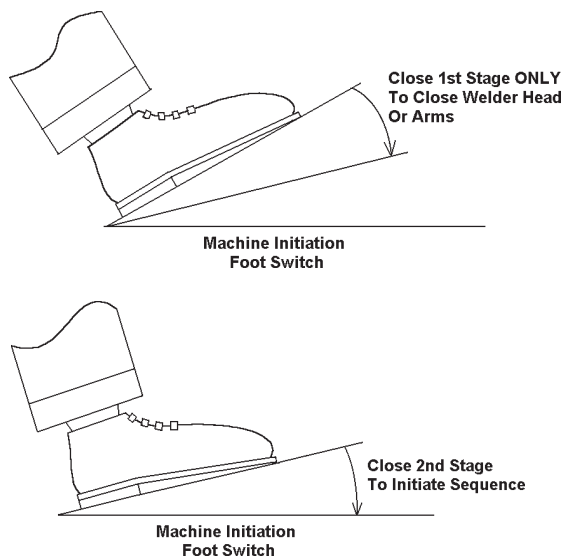


Make sure that all unnecessary parameters are set to 00 before going to OPERATE mode.



**Figure B-16.** Put control in OPERATE mode

## APPENDIX B PROGRAMMING AND SETUP (cont.)



**Figure B-17.**  
*Closed head or  
arms*

Make sure machine head (or arms) closes properly. (On machines with Single Stage initiation, depressing the foot switch will sequence the control but will not weld.)

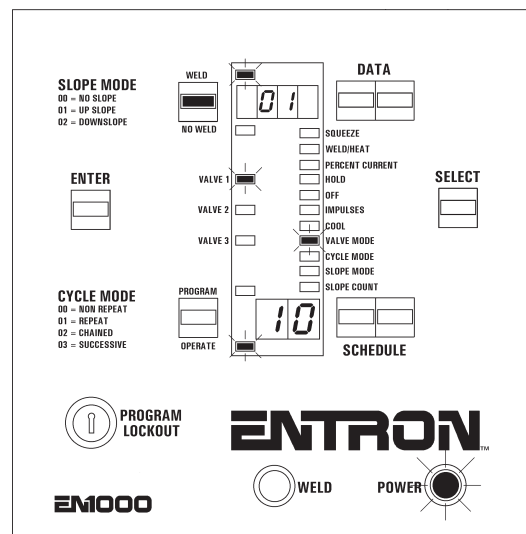
Machine will sequence but **will not weld**, then the head (or arms) will retract.

Put the control in WELD mode (see Figure B-18).

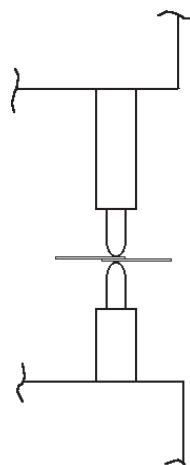
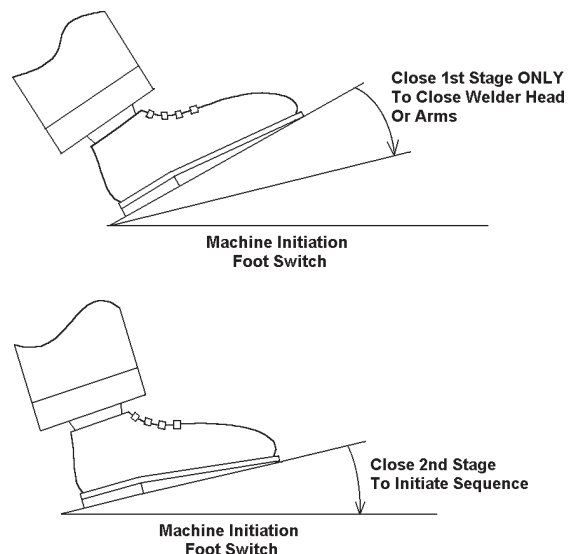
Place sample parts to be welded between electrodes, and initiate weld sequence again.

Machine head (or arms) will close on parts to be welded. (On machines with Single Stage initiation, depressing the foot switch will sequence the machine and weld.)

Machine will go through sequence, and **weld**, then the head (or arms) will retract.



**Figure B-18.** *Put control in WELD mode*



**Figure B-19.** *Welding  
the sample part*

## APPENDIX B PROGRAMMING AND SETUP (cont.)

Before running production quantities of welded parts, ENTRON recommends destructive testing of the welds. Set the welding machine to RWMA recommended standards. Weld the parts. Then clamp one end of the welded part in a vise and **PEEL** the other side back against the weld. Ideally, in low carbon steel, the weld will pull a hole through one or the other parent materials.

**To make the best possible weld for the material to be welded, use:**

1. The **LOWEST** transformer tap setting,
2. The **HIGHEST PERCENT CURRENT** setting, and
3. The **SHORTEST WELD** count setting.

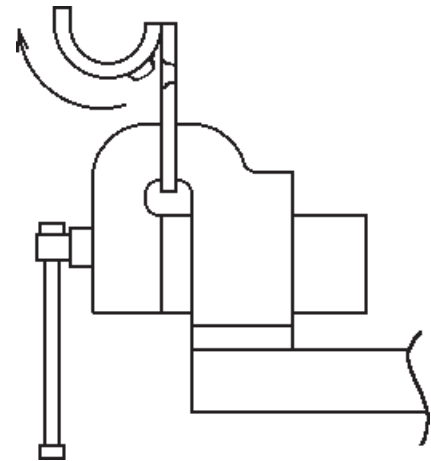


Figure B-20. Destructive test

### B-2.0 CONSTANT CURRENT PROGRAMMING AND SETUP (EN1001 only)

Put control in PROGRAM mode, as shown in Figure B-8. Find the EXTENDED FUNCTIONS by pressing the SELECT push button until **EF** appears in the DATA display. Use SCHEDULE push buttons to scroll through the EXTENDED FUNCTIONS.

Based on Current Sensor and desired CONSTANT CURRENT mode, program **C.r.** and **r.R.** to enable CONSTANT CURRENT. For **C.r.=32** or **33**, only [kA] mode is possible, and **r.R.** must be programmed according to desired RANGE (see Table 8-1). Programming [%] mode is shown in Figure B-21, and programming RANGE of 30 kA for [kA] mode is shown in Figure B-22.

For programming four-digit data parameters, the two DATA push buttons are used as follows: Press right DATA push button to increase by one, press and hold to increase by ten. Press left DATA push button to increase by 100, and press and hold to increase by 1000.

After selecting and programming desired CONSTANT CURRENT mode, run setup if necessary.

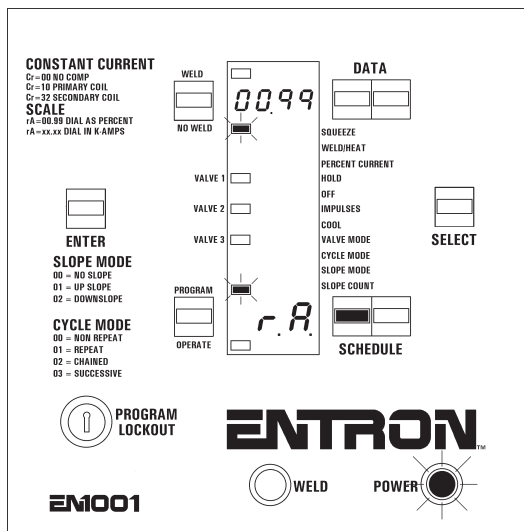


Figure B-21. Program RANGE for [%] mode

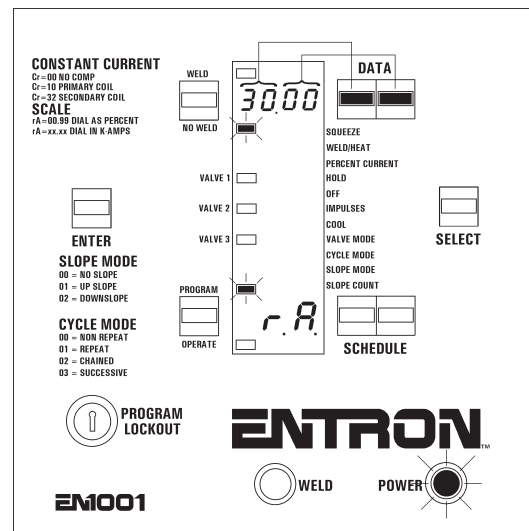


Figure B-22. Program RANGE for [kA] mode

## APPENDIX B PROGRAMMING AND SETUP (cont.)

For Primary Coil Sensing,  
program **10** through **19**.

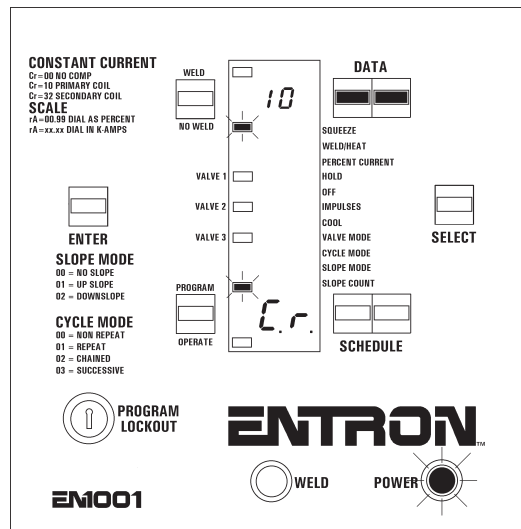
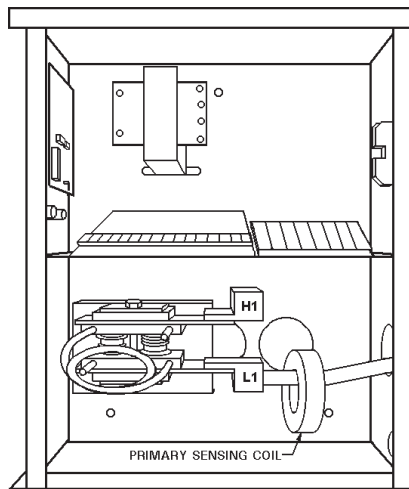


Figure B-23. For Primary Coil Sensing

For Secondary Rogowski Coil Sensing,  
program **30**, **31**, **32**, or **33**.

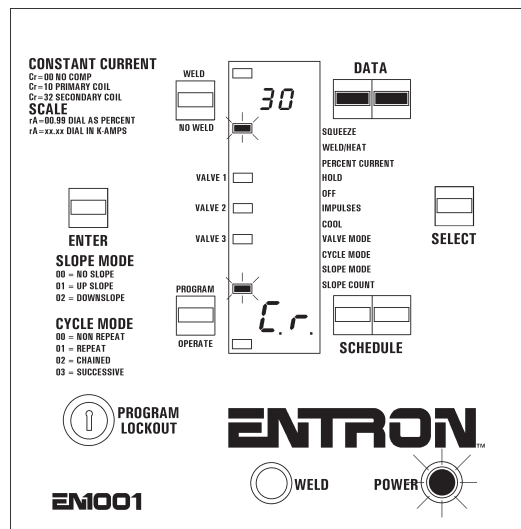
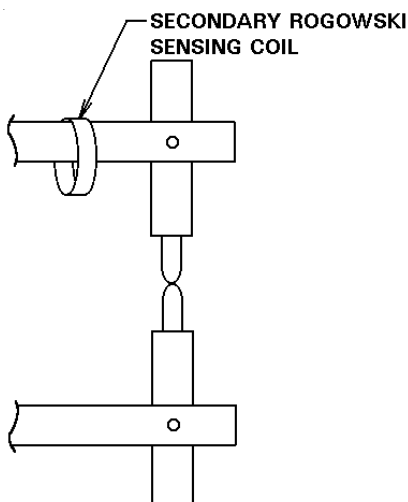


Figure B-24. For Secondary Rogowski Coil

In order to self-adjust gains for Current Sensor signal, control must automatically perform setup procedure, as described in Section 8.4.1. This setup procedure is necessary only for following CONSTANT CURRENT modes:

**C.r.=10** or **11** – for Primary Coil

**C.r.=30** or **31** – for Secondary Rogowski

After programming **C.A.=04**, as shown on Figure B-25, follow the setup procedure described in Section 8.4.1.

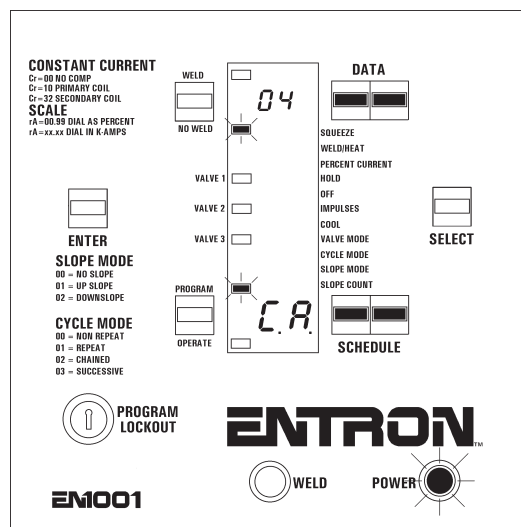


Figure B-25. Prepare control for setup



## APPENDIX B PROGRAMMING AND SETUP (cont.)

Initiate the control using the FS3 terminal input ONLY. Bring the heads together on a previously welded part. Hold the initiation contacts closed while the machine sets up the CONSTANT CURRENT parameters. When a Primary Sensing Coil is used, this initiation will cause the control to fire several times then count down on the Dial Plate from **99 (99, 98, 97, ..., to 20)**. The display will switch to schedule 00 when the CONSTANT CURRENT routine has completed successfully.

### NOTICE

Setup must be run in SPOT welding mode. When setting up this control on a seam welder, the EXTENDED FUNCTION parameter for SEAM mode should be set to **S.E.=00**. If welding very thin gauges of material (20 Ga. or thinner), setup could be done without a coupon, wheel to wheel. If operating a seam welder, stop the motor which turns the wheels.

# APPENDIX C S49 SCHEDULE SELECT OPTION INSTALLATION

## C-1.0 CUSTOMER INSTALLATION OF S49 SCHEDULE SELECT OPTION In an existing EN1000 or EN1001 “T/D” or “L” Cabinet

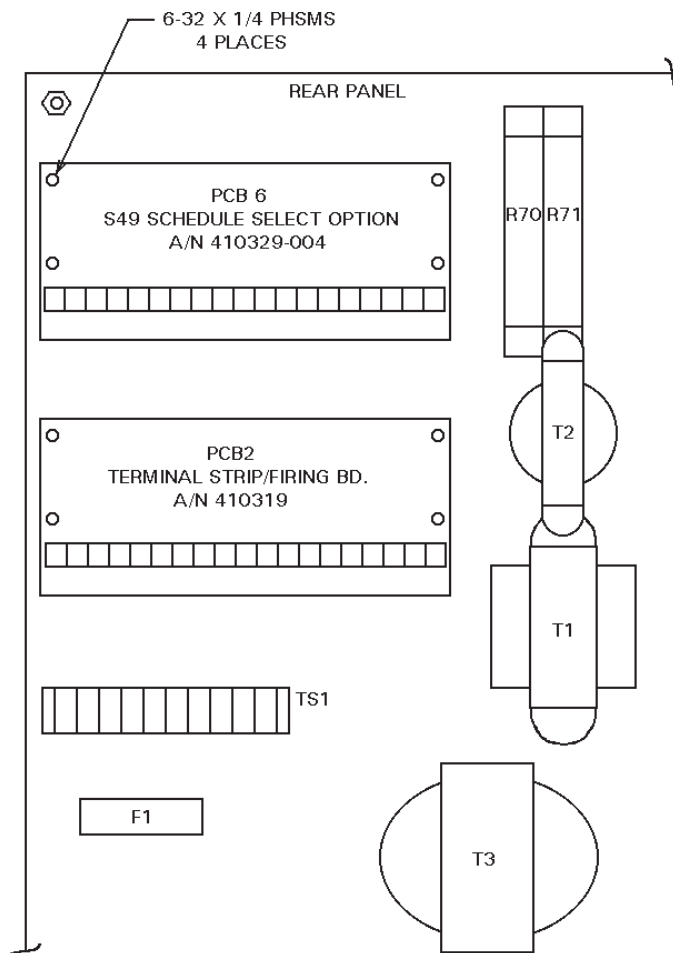
600675-001 EN1000	600675 EN1001	PARTS LIST	
QUANTITY	PART NO.	DESCRIPTION	
1		600541-009	PCB Assem., Seq. Ctrl. Bd., EN1000/S49
	1	600572-009	PCB Assem., Seq. Ctrl. Bd., EN1001/S49
1		421210-032	Wiring Diagram, EN1000/S49-Series, T/D/L Cabinet
	1	421269-018	Wiring Diagram, EN1001/S49-Series, T/D/L Cabinet
1	1	410329-004	Assembly, PCB, S49 Option
1	1	322458	Harness Assembly, J4-J4
4	4	557003	6-32 x 1/4 PHSMS, Phil., Brite

1. Remove **ALL** power to control. Open door.
2. Mount the S49 Option PCB (A/N 410328) to standoffs on rear panel using four (4) 6-32 x 1/4 PHSMS, Phil., Brite (see Figure C-1).
3. Connect J4-J4 Harness (A/N 322458) per Wiring Diagram included with this kit.

**NOTICE**

On the Wiring Diagram, the dark band on connectors indicates stripe on ribbon harness. Harness **MUST** be installed with ribbon harness stripe oriented correctly.

4. Close door. Reapply power.



**Figure C-1.** Mounting detail for “T/D” or “L” Cabinet

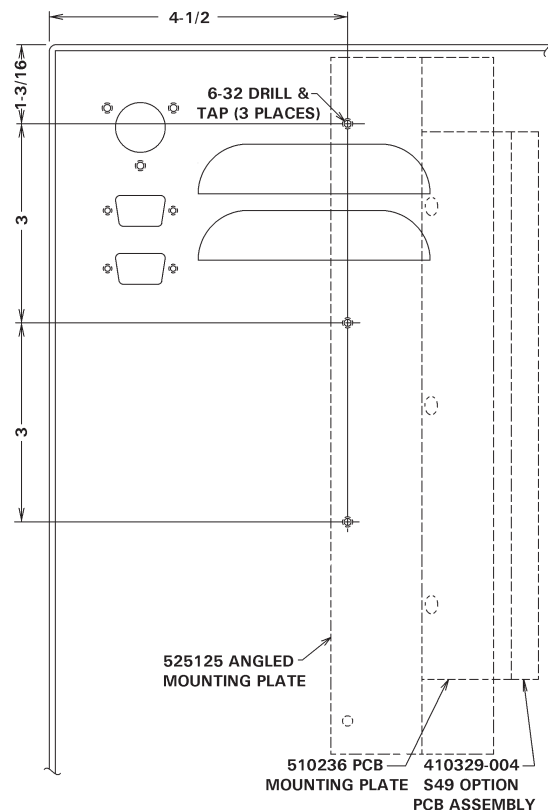
## C-2.0 CUSTOMER INSTALLATION OF S49 SCHEDULE SELECT OPTION In an existing EN1000 or EN1001 “E” Cabinet

600675-003 EN1000	600675-002 EN1001	PARTS LIST	
QUANTITY	PART NO.	DESCRIPTION	
1	600541-009	PCB Assem., Seq. Ctrl. Bd., EN1000/S49	
1	600572-009	PCB Assem., Seq. Ctrl. Bd., EN1001/S49	
1	421212-009	Wiring Diagram, EN1000/S49-Series, E Cabinet	
1	421268-012	Wiring Diagram, EN1001/S49-Series, E Cabinet	
1	525125	Bracket, Terminal Strip/PCB Mtg.	
1	510236	Assem., Mtg. Plate, Term Strip/Firing Bd.	
1	410329-004	Assembly, PCB, S49 Option	
1	322525	Harness Assembly, J4-J4	
7	557003	6-32 x 1/4 PHSMS, Phil., Brite	
3	557006	6-32 x 3/8 PHSMS, Phil., Brite	
3	557017	#6 Split Lockwasher	
3	557018	6-32 x 1/4 AF Hex Nut	

1. Remove **ALL** power to control. Open door.
2. Drill rear panel of cabinet as indicated in Figure C-2. Mount angled bracket (P/N 525125) using the 6-32 x 3/8 Screws, Split Lockwashers and Nuts provided. Mount the PCB Mounting Plate (A/N 510236) using three (3) of the 6-32 x 1/4 Screws and Lockwashers.
3. Mount the S49 Option PCB (A/N 410328) to standoffs on the PCB Mounting Plate with the J4 connector at the top, using four (4) 6-32 x 1/4 PHSMS, Phil., Brite (see Figure C-2).
4. Connect J4-J4 Harness (A/N 322458) per Wiring Diagram included with this kit.

**NOTICE**

On the Wiring Diagram, the dark band on connectors indicates stripe on ribbon harness. Harness **MUST** be installed with ribbon harness stripe oriented correctly.



**Figure C-2.** Mounting detail for  
“E” Cabinet

5. Vacuum or otherwise remove ALL metal chips. Close door. Reapply power.

### C-3.0 CUSTOMER INSTALLATION OF S49 SCHEDULE SELECT OPTION In an existing EN1000 or EN1001 “S” Cabinet

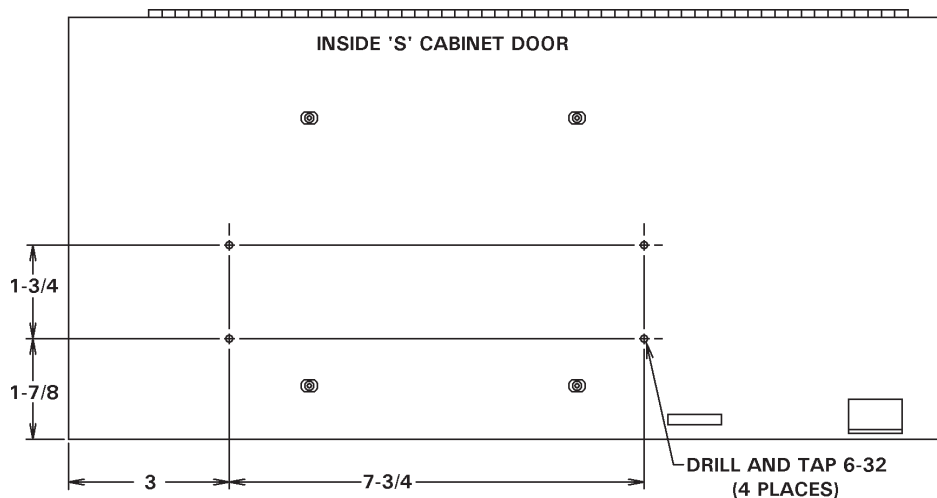
600675-005 EN1000	600675-004 EN1001	PARTS LIST	
QUANTITY	PART NO.	DESCRIPTION	
1		600541-009	PCB Assem., Seq. Ctrl. Bd., EN1000/S49
	1	600572-009	PCB Assem., Seq. Ctrl. Bd., EN1001/S49
1		421180-010	Wiring Diagram, EN1000/S49-Series, S Cabinet
	1	421270-008	Wiring Diagram, EN1001/S49-Series, S Cabinet
1	1	410329-004	Assembly, PCB, S49 Option
1	1	322539	Harness Assembly, J4-J4
4	4	557003	6-32 x 1/4 PHSMS, Phil., Brite
4	4	557006	6-32 x 3/8 PHSMS, Phil., Brite
4	4	555031	6-32 x 1/2 Standoff, Hex Threaded Brass

1. Remove **ALL** power to control. Open door.
2. Drill and tap door of cabinet as indicated in Figure C-3. Install the standoffs by using four (4) 6-32 x 3/8 Screws from the outside of the door, 6-32 x 1/2 standoffs on inside of the door.
3. Mount the S49 Option PCB (A/N 410328) to the standoffs with the J4 connector towards the rear panel of the cabinet, using four (4) 6-32 x 1/4 PHSMS, Phil, Brite.
4. Connect J4-J4 Harness (A/N 322539) per Wiring Diagram included with this kit.

**NOTICE**

On the Wiring Diagram, the dark band on connectors indicates stripe on ribbon harness. Harness **MUST** be installed with ribbon harness stripe oriented correctly.

5. Vacuum or otherwise remove ALL metal chips. Close door. Reapply power.



**Figure C-3.** Mounting detail for “S” Cabinet

## APPENDIX D

# Weldsafe 5000

combination ground fault sensing and ground checking relay for  
AC 50-60 Hz manual transgun applications

### Weldsafe 5000 Features

- ◆ 10 mA trip point setting for ground fault sensing
- ◆ C.T. loop monitoring
- ◆ 1  $\Omega$  single trip point for ground checking
- ◆ Voltage Build-up Detection
- ◆ Optional End-of-Line Resistor for crush fault detection
- ◆ Harmonic filtering

---

The Weldsafe 5000 combination ground fault current and ground check relay has been designed to provide sensitive ground fault protection and continuous ground checking for ac, 50-60 Hz manual transguns in accordance with RWMA Bulletin 5 standards.

---

### Weldsafe 5000 Operation

#### Ground Fault Sensing Operation

The Weldsafe 5000 protects operators and equipment from dangerous leakage currents that may occur when a circuit is energized. The device has harmonic filtering to prevent nuisance tripping and a pick-up response time of < 25mS.

#### • Ground Fault Protection

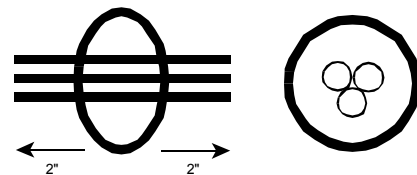
The Weldsafe 5000 ground fault function has two ground fault settings which will typically correspond to the size of the manual transgun. Setting 1 is the factory setting. This setting should always be used whenever practicable. Generally, Setting 1 will work for transguns smaller than 100 KVA. For manual guns larger than 100 KVA or with very high amperages (>40,000A), Setting 2 can be selected. All settings meet or exceed current RWMA recommendations. To determine which setting is correct, consult with your service operator.

#### • C.T. Loop Monitoring

The Weldsafe 5000 also continuously monitors the connection to the current transformer to ensure proper functioning of the ground fault sensing. If this connection is broken, the unit will immediately operate.

#### • CT600/.../WKE Series Current Transformers

The ground fault protection function of the Weldsafe 5000 operates together with a CT600 series current transformer. There are different sizes available ranging from 1" to 5-1/8" depending upon the size of the load conductors passing through window. The C.T. is connected across terminals 16 and 17. Only the load carrying conductors pass through the C.T. The ground wire must remain outside the C.T. core. It is also important that the cables passing through the C.T. be as straight as possible (see diagram) to minimize the possibility of core saturation.



#### CT600/60/2 for High Current Applications

In applications where very high current is present, as in the case of a very large hand-held welding gun (>100KVA, 40,000A), this high current may influence the operation of the CT and cause nuisance tripping. The mounting and location of the CT within the control panel is very important. In order to get optimum results from the CT, it is recommended that the CT be mounted on the output side. This reduces the influence of any internal leakage caused by components in the welding control. For systems above 100 KVA, it is advisable to use either coaxial cable or order the CT600/60/2. This CT has been specifically designed with a 6" metal core insert and provides the same shielding from the high current as the coaxial cable.

#### Ground Checking Operation

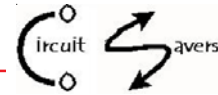
The Weldsafe 5000 has several protective methods to ensure proper grounding of fixed or portable equipment. If the unit senses any one of the following conditions, it activates the alarm relay (K2).

#### • Pilot Wire Ground Integrity Check

The Weldsafe 5000 monitors the resistance of the return path to ground via a ground connection from terminal 30 and a standard loop pilot wire going to the equipment from terminal 27. The unit continuously sends a

# APPENDIX D WELDSAFE 5000 (cont.)

## Weldsafe 5000 combination ground fault sensing and ground checking relay



measuring signal around the ground loop circuit. This circuit comprises the main equipment grounding conductor, a section of the equipment casing and a pilot conductor return path. When the Weldsafe 5000 detects a loop resistance in excess of 1  $\Omega$ , it will activate the output alarm relay (K2). The response time will vary depending upon the actual loop resistance value. A time delay of up to 2 S can occur for values less than 2  $\Omega$ . The Weldsafe will react in < 30 mS for values approaching "open circuit" (see Table 1).

- **Earth Voltage Build-up**

The Weldsafe 5000 can also detect large ground fault currents that may cause unsafe voltage build-up on the ground path. If the unit senses a voltage >30 V ac on the ground path, it will immediately react to this condition.

- **Optional End-of-Line Resistor (EOL)**

The Weldsafe 5000 ground checking operation has an additional protection feature. The unit can detect crush or parallel faults. This situation occurs when the cable ground wire becomes unintentionally connected to the equipment pilot wire. To sense this fault, a grounding resistor is connected at the end of the pilot wire from terminal 29. In this configuration, the Weldsafe 5000 will alarm if the ground wire ever comes into contact with the equipment pilot wire. This grounding resistor must have a value of 49.9 ohms with a high tolerance of +/- 0.1% to ensure proper function of the Weldsafe 5000. Circuit Savers can supply this resistor on request. *Please note: this end-of-line (EOL) will not affect the operation of the earth voltage build-up function.*

## Weldsafe 5000 Technical Information

### Mounting and Wiring

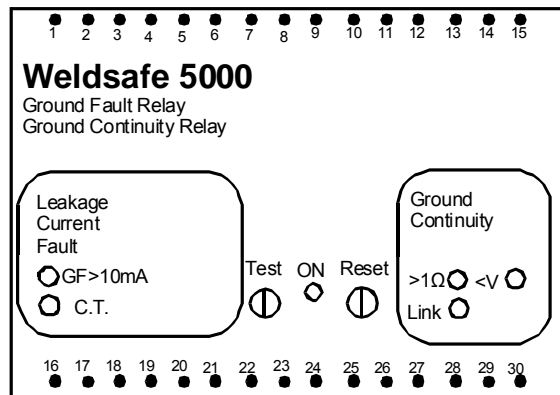
The Weldsafe 5000 can be either DIN rail mounted (35mm) or screw-mounted by the 2 holes at the corners of the device. Terminals are clearly marked for connection.

### Input Power Supply

The Weldsafe 5000 requires an auxiliary power supply of either 24 V ac or 120 V ac, 50-60 Hz. Customer must specify.

### Trip/Alarm Output Relays

Two sets of changeover trip/alarm contacts (one for ground fault, one for ground check) are provided rated at 250 V, 5 A. These two relays can be set for tripping or remote indication. They can be configured for either failsafe or active operation, manual or auto reset. Factory settings are Failsafe and Auto Reset. To adjust relay for Failsafe/Active operation for either ground fault or ground check, open front cover. There is a small blue button in the left and right lower areas. The switch on the left changes the ground fault, the one on the right changes the ground check. For Hand reset close contacts between 18-19, open for Auto.



### LEDs

In addition to the trip relays there are six LED indicators on the front cover. The green LED indicates POWER ON. There are two red LEDs for the ground fault function:

- "GF" indicates leakage in excess of preset trip level
- "C.T." indicates C.T. connection broken

There are three LEDs indicating different conditions on the ground check function:

- "1 $\Omega$ " indicates ground loop resistance in excess of 1 ohm
- "Link" indicates ground wire connected to pilot wire
- ">V" indicates voltage build-up in excess of 30 V ac

### Test/Reset

The test facilities on the Weldsafe 5000 may be operated locally or remotely. They test both the ground fault sensing and the ground checking circuits. The test button, S1 is used to simulate a ground fault condition internally as a means of testing the relay function. An external test button can also be used to perform the same function test.

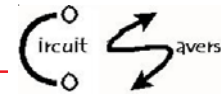
### CT600 Current Transformers

CT600/25/WKE	1" internal diameter
CT600/60/WKE	2 1/3" internal diameter
CT600/95/WKE	3 3/4" internal diameter
CT600/130/WKE	5 1/8" internal diameter

CT/600/60/2                      2 1/3" internal diameter for high current applications, 6" metal insert

# APPENDIX D WELDSAFE 5000 (cont.)

Weldsafe 5000 combination ground fault sensing and ground checking relay



## Technical Data

Nominal AC insulation voltage ..... 500 V ac  
 Insulation group to UL 1053  
 and VDE 0110(01.83) ..... Dirty group 2  
 Test voltage ..... 3000 V ac  
 Operation class ..... Continuous  
 Input supply voltage ..... 24 V ac or 120 V ac, 50-60 Hz  
 Working range ..... +/- 15%  
 Maximum self-consumption ..... 10 VA  
 Alarm relay contacts ..... Volt-free NO/NC  
 Switching capacity ..... 1100 VA  
 Rated contact voltage ..... 250V  
 Continuous current ..... 5A  
 Breaking capacity .....  
 At: 240V ac, P.F.=0.4 ..... 3A  
 At: 110V dc, @L/R=0 ..... 0.3A  
 Adjustable function ..... Failsafe/Active  
 Relay alarm memory ..... Manual/Auto reset  
 Factory settings ..... Failsafe/Auto  
 Operating ambient temperature ..... -10° to +60° C  
 Storage ambient temperature ..... -40° to +70° C

### Mounting

Terminal ..... M 2.5  
 Terminal capacity ..... 0.5 to 4 mm<sup>2</sup>  
 Torque Force ..... 0.8 Nm

### Ground fault function

Trip level  
 Setting 1 ..... factory setting  
 S8 closed ..... 10 mA, +0%/-15%, ac 50-60 Hz  
 Response time ..... 20 – 25 mS Response time  
 Setting 2  
 S8 open ..... 10 mA, +0%/-15%, ac 50-60 Hz  
 Response time ..... Inverse time::current, see below  
 Current transformer .... CT600/.../WKE or CT600/60/2  
 Sizes ..... 1" – 5-1/8" internal diameter

### Ground check function

Loop resistance measuring current ..... DC 20 mA  
 Trip Level ..... 1Ω, +/-15%  
 Stray voltage  
 (terminals 30-27 or 30-29) ..... Max. 300 V ac (<5 sec)  
 Response time  
 0.5Ω - open circuit ..... <30 mS  
 Response time curve ..... see Table 1  
 Hysteresis ..... Approx. 2%  
 Voltage response ..... > 30 V ac

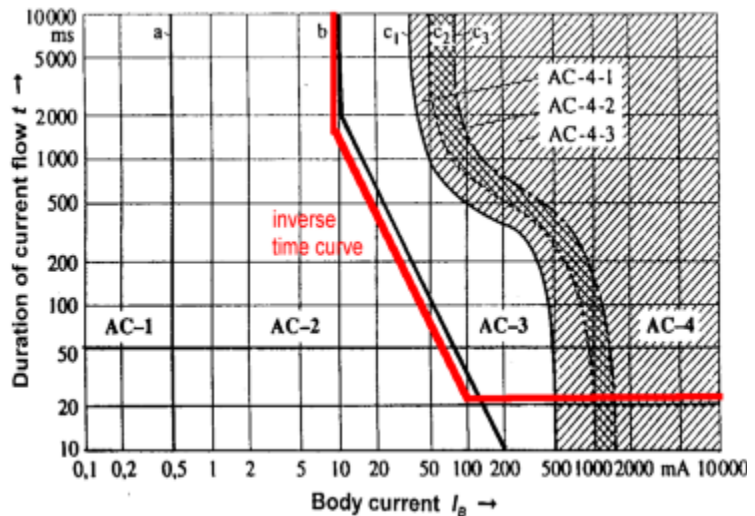
Weight ..... 575 g  
 Dimensions ..... 2.96"H x 3.94"W x 4.33"D

Industry Standards ..... RWMA 5-015.68.04  
 ..... in accordance with UL Class B

Table 1

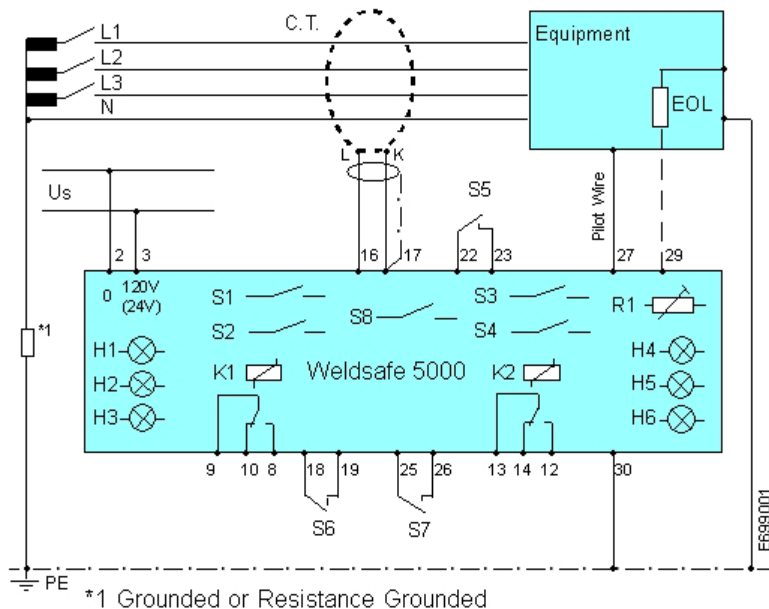
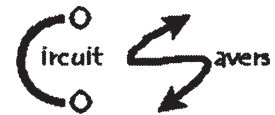
Response Time for Ground Loop value change 0.5 Ω to R Ω	
0.5 Ω - 2 Ω	≈ 1.8 S
0.5 Ω - 5 Ω	≈ 1.8 S
0.5 Ω - 8 Ω	≈ 1.8 S
0.5 Ω - 10 Ω	≈ 1.8 S
0.5 Ω - 20 Ω	≈ 310 mS
0.5 Ω - 50 Ω	≈ 100 mS
0.5 Ω - 100 Ω	≈ 60 mS
0.5 Ω - 200 Ω	≈ 42 mS
0.5 Ω - Open	≈ 21 mS

Inverse Response Time Curve for Setting 2



# APPENDIX D WELDSAFE 5000 (cont.)

Weldsafe 5000 combination ground fault sensing and ground checking relay



**PLEASE NOTE:**  
**TO CHECK UNIT FUNCTION DURING COMMISSIONING, WE RECOMMEND TESTING THE Weldsafe 5000 UNDER TRUE FAULT CONDITIONS. FOR THE GROUND FAULT FUNCTION, A SMALL RESISTOR, (e.g. 30 KΩ AT 480V WILL GENERATE APPROX. 16 mA) CAN BE USED TO CREATE THIS CONDITION. FOR THE GROUND CHECKING FUNCTION, OPEN THE PILOT WIRE.**

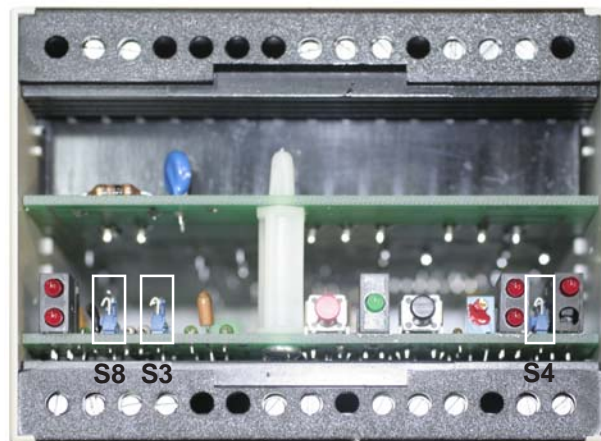
### Legend

- H1 LED green POWER ON
- H2 LED red GROUND FAULT
- H3 LED red CT FAULT
- H4 LED red LOOP RESISTANCE > 1Ω
- H5 LED red CRUSH FAULT
- H6 LED red VOLTAGE BUILD-UP
- K1 Ground fault alarm relay
- K2 Ground check alarm relay
- S1 Internal test button
- S2 Internal reset button
- S3 Switch for ground fault Failsafe/Active (behind front cover)  
Closed=active Open=failsafe
- S4 Switch for ground check Failsafe/Active (behind front cover)  
Closed=active Open=failsafe
- S5 External test button
- S6 External reset button for ground fault sensing
- S7 External reset button for ground checking
- S8 Trip level adjustment (behind front cover)  
Closed = 10 mA fixed, factory setting  
Open = 10 mA inverse response
- \*\*R1 Loop resistance adjustment - see instructions

### Terminals

- 2-3 Input power supply 120V ac or 24 V ac +/-15%
- 8-9-10 Contact for K1 alarm relay – ground fault
- 12-13-14 Contact for K2 alarm relay – ground check
- 16-17 C.T. connection
- 18-19 Ground fault external reset, Hand=closed Auto=open
- 22-23 External test button (optional)
- 25-26 Ground check external reset, Hand=closed Auto=open
- 27 Pilot wire if using standard ground check monitoring
- 29 Pilot wire if using EOL monitoring
- 30 Ground connection
- EOL End-of-line resistor, 49.9Ω, +/-0.1

**\*\*R1 Loop Resistance Adjustment**  
 This is an internal adjustment that must be made when cable length is very long and the loop resistance is high (0.5-.0.8Ω). Please check with manufacturer about your specific application.





# APPENDIX D WELDSAFE 5000 (cont.)

## MODIFICATION NOTES

DRAWING NUMBER <b>600695 -</b>	REV <b>B</b>	
-----------------------------------	-----------------	--

4
3
2
1

C
B
A

Make from: 309516

**Ⓐ**  
 INTERIOR VIEW - WELDSAFE 5000  
 For proper operation CLOSE Switch S3  
 For proper operation CLOSE Switch S4  
 For proper operation CLOSE Switch S8

REF: SEE ALSO  
600707 - ASSEM, RELAY, RESIDUAL CURRENT & GROUND DETECTION 1000Hz

B	ECN 2928	CHANGED SWITCH 8 TO CLOSED, FOR A 20mSEC RESPONSE TIME	DPDII 09-14-08
A	ECN 2711	CHG'D DRWG. 309516 WAS WELDSAFE 4000 IS WELDSAFE 5000, ADDED SWITCH S8.	RHL 3/15/02
-	-	ORIGINAL RELEASE	
REV	AUTH	DESCRIPTION	DRWN BY DATE
<b>ENTRON CONTROLS INC</b>			
SCALE	DATE	DRAWN BY	CHK'D BY
1/2"	3/15/02	RHL	APPROVED BY
TOLERANCE UNLESS SPECIFIED			
ANGLES: ± 1/2°		REVISED	
DECIMALS: ± .010		REV LTR	APPROVED BY
FRACTIONS: ± 1/64		B	B
		DATE	DPDII
		14 OCT 08	14 OCT 08
ASSEM, RELAY, RESIDUAL CURRENT & GROUND DETECT, 5000Hz			
NEXT ASSM/USED ON	DRAWING NUMBER		REV
	600695-		B

4
3
2
1

C
B
A

8 1/2 x 11  
ENTRON 470049

# APPENDIX E EN1000/EN1001 BENCH CONTROLS

## Wiring Diagrams EN1000-B Controls – 421262 Series EN1001-B Controls – 421447 Series

### E-1.0 GENERAL DESCRIPTION

The EN1000 and EN1001 Bench Controls use a smaller “B” style cabinet. This Bench Control has many of the same functions as standard EN1000/EN1001 Controls. It uses a different Terminal/Firing Board and includes a Polarity Reverse switch.

The information presented in this Appendix highlights those functions unique to the EN1000-B and EN1001-B Controls. All other functions and details have been covered previously in this manual.

### E-2.0 CONTROL PANEL LAYOUT

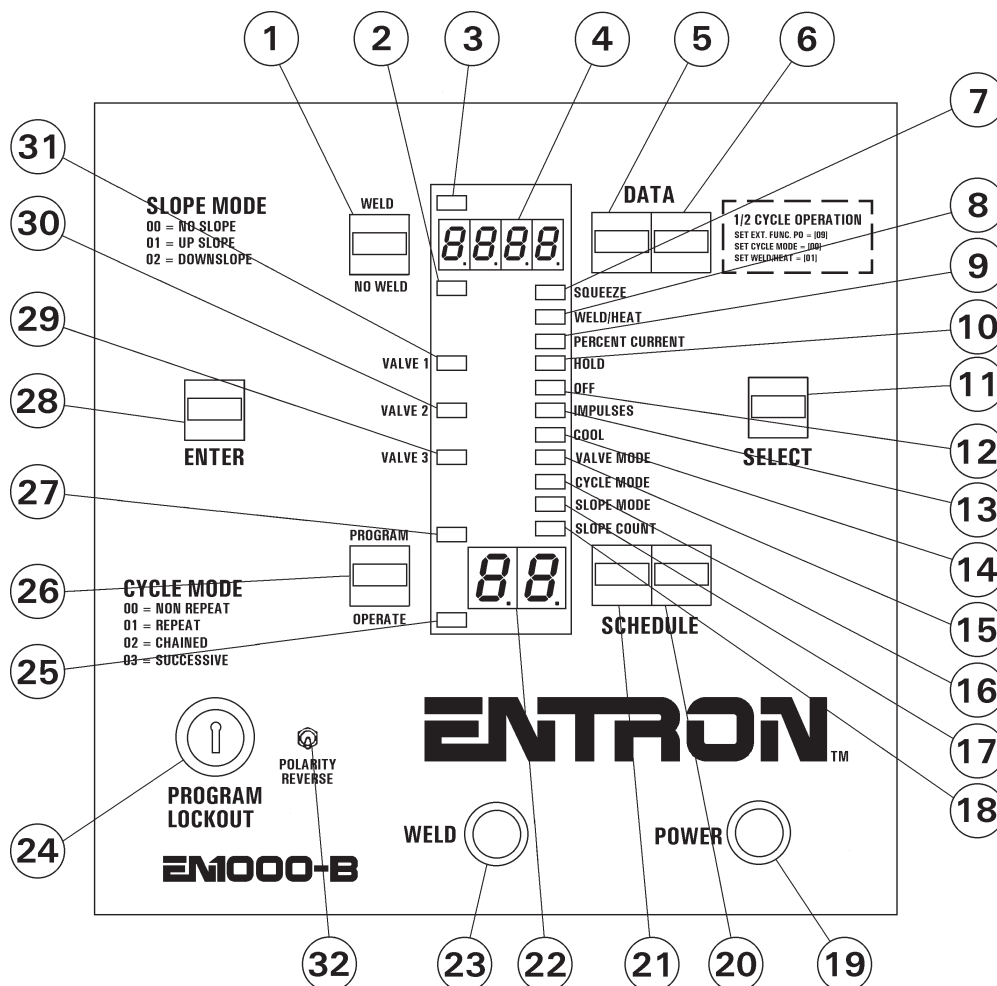


Figure E-1. Control Panel layout

Additions to Control Panel of EN1000-B and EN1001-B Controls include Polarity Reverse switch (Item 32) and programming information for HALF CYCLE operation.

## APPENDIX E EN1000/EN1001 BENCH CONTROLS (cont.)

### E-2.1 CONTROL FUNCTIONS

Descriptions and functionality of Control Panel features numbered 1-31 shown in Figure E-1 are found in Section 2.0 Programmable Functions.

**POLARITY REVERSE SWITCH (32)** – When in default multi-cycle spot welding, this switch controls the polarity of the first half cycle of a multi-cycle weld. When in HALF CYCLE mode, this switch can change the polarity of a single 1/2 cycle of weld current. See Section 5.4.7 Process Outputs for details of programming HALF CYCLE operation.

#### NOTICE

**VALVE LEDs** – Even though three valves can be programmed, only Valve 1 is available as an output on this control. Available VALVE codes are indicated in Table E-1.

**Table E-1. VALVE codes**

CODE	TS1-SV1
00	
01	X
02	
03	X
04	
05	X
06	
07	X

#### NOTICE

EXTERNAL SCHEDULE SELECT (**5.5.=01**) can be programmed but is not available in the EN1000-B and EN1001-B Controls.

# APPENDIX E EN1000/EN1001 BENCH CONTROLS (cont.)

## E-3.0 INSTALLATION & MOUNTING DIAGRAMS – “B” CABINET

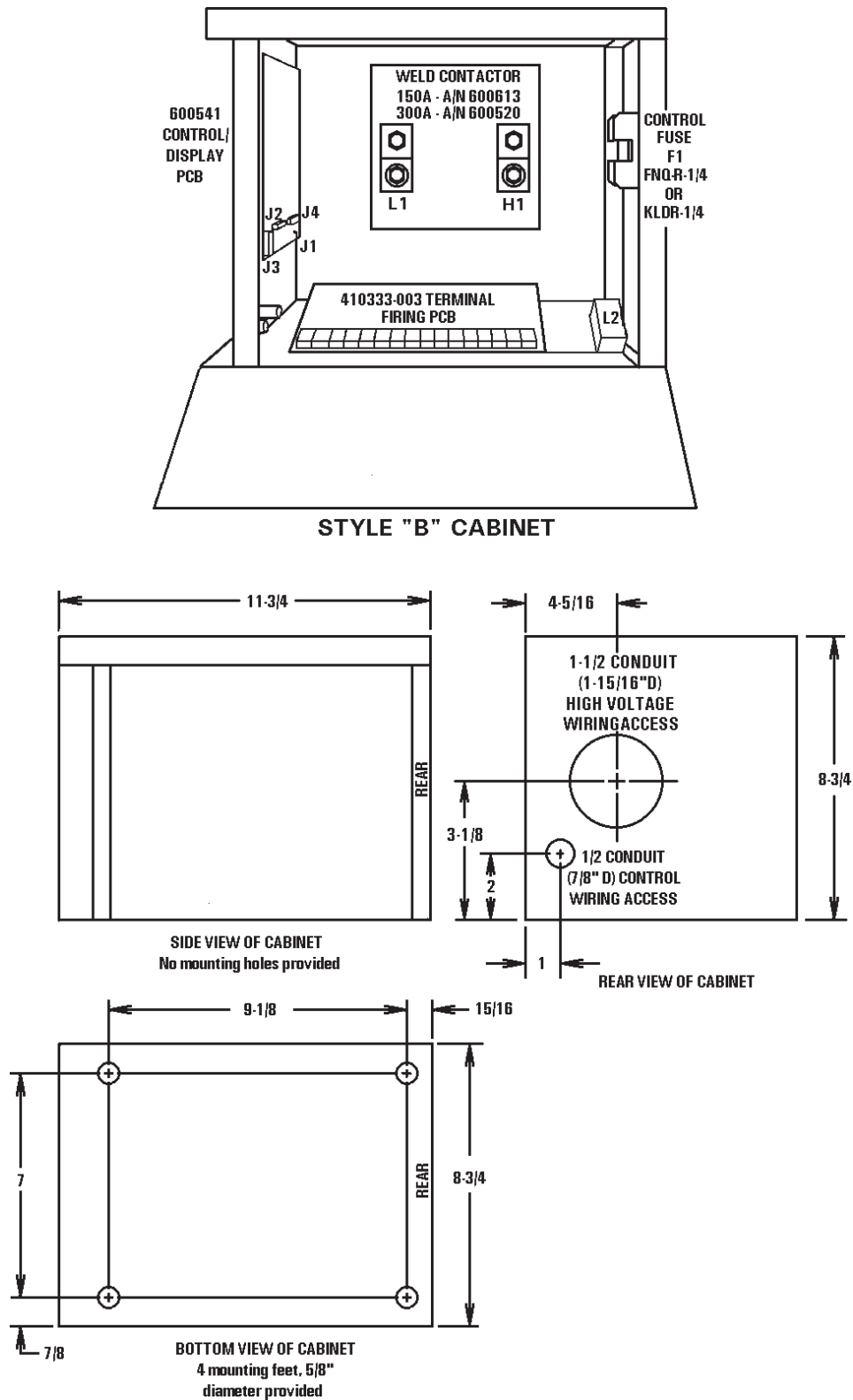


Figure E-2. “B” Cabinet installation and mounting diagrams

# APPENDIX E EN1000/EN1001 BENCH CONTROLS (cont.)

## E-4.0 TERMINAL STRIP DIAGRAM

For Terminal Strip connections, see appropriate Wiring Diagram and Section 4.3.2 Terminal Strip Connections.

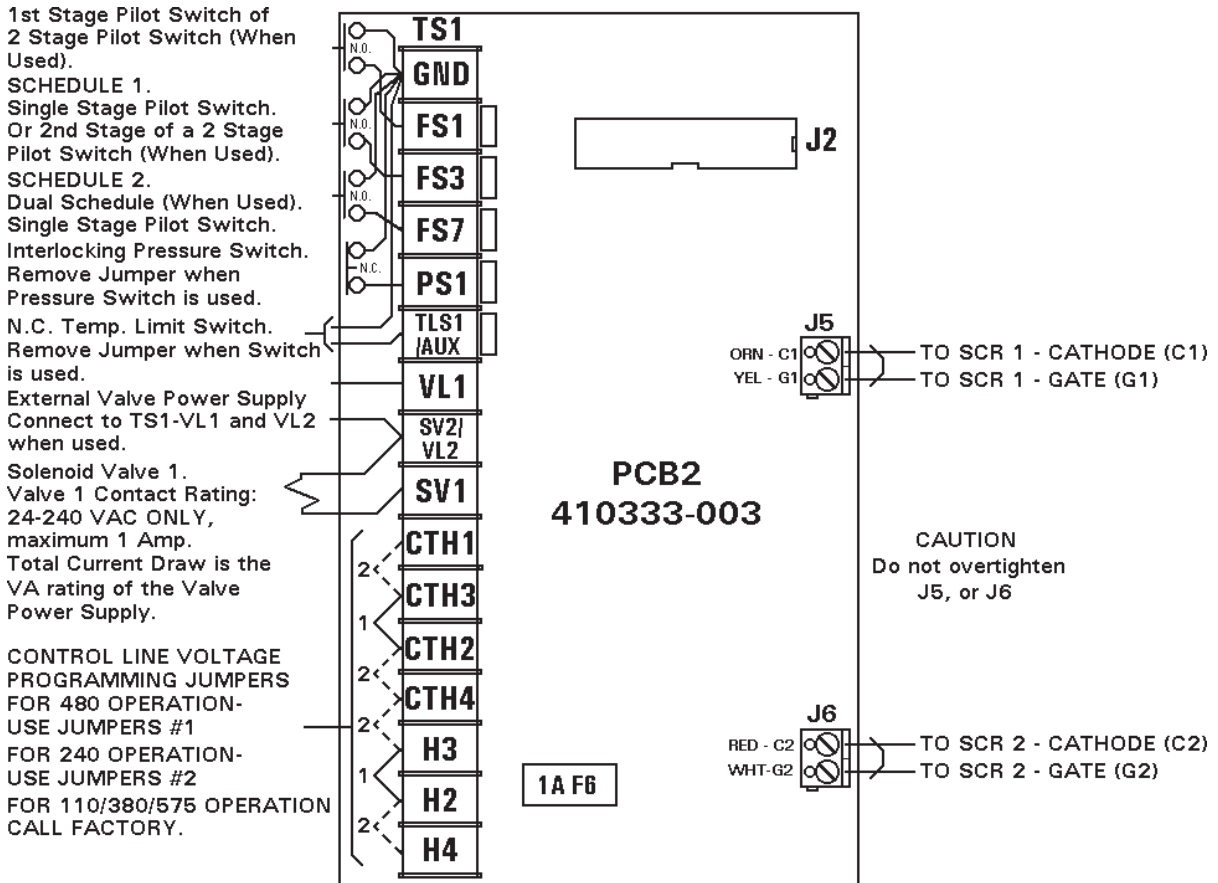


Figure E-3. Terminal Strip TS1/PCB2

# APPENDIX F EN1003 THREE PHASE DC CONTROLS

## Wiring Diagrams

### EN1003 Controls in "L" & "H" Cabinets – 421291 Series EN1003 Controls in "T/D" Cabinets – 421310 Series

Three Phase DC applications are frequently characterized by:

1. High weld current requirements typically with poor secondary power factor configurations.
2. One common core transformer or three individual transformers connected three phase.
3. Secondary diode configurations of either half or full wave rectification.

Typical jobs that require DC weld controls are those that require either large secondary currents or, by design, have high power losses caused by ferrous metals in the throat of the welder, such as parts of the machine and/or welded parts. Because of the DC current, rather than AC, in the secondary path, inductive losses are cut to a minimum and only resistive losses are of a concern.

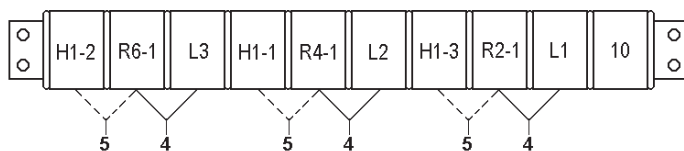
This Appendix is to be used in conjunction with Wiring Diagram 421291 ("L" & "H" Cabinets) or 421310 ("T/D" Cabinets) and this manual, which is applicable to all models in the EN1003 Series. However, some sections of this manual apply only to EN1000 and EN1001 Series Single Phase Controls and should be disregarded for EN1003 Controls.

Sections to be disregarded are as follows:

- Section 1.1 (Standard Features) – Notice concerning 60 Hz or 50 Hz operation
- Sections 3.1, 3.2, 3.3, 3.4, 3.5 (Installation and Mounting Diagrams)
- Section 3.6 (Welding Transformer Primary Wiring)
- Section 3.7 (External SCR Contactor Wiring)
- Section 4.1 (Operating Voltage)
- Section 4.2 (Fusing)
- Section 4.3.3 (Terminal Strip TS1 Inside the Cabinet)

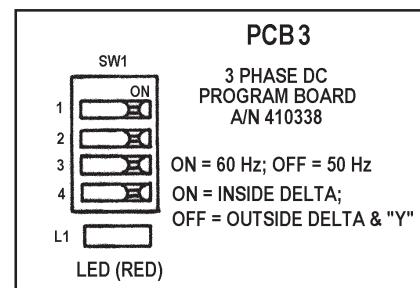
Information contained in this Appendix and on Wiring Diagrams replaces the information contained in these sections.

All EN1003 models fire three welding contactors, controlled by one digital phase shift heat control setting, and may be connected to the welding transformers in an outside delta, inside delta, or "Y" configuration (see Figures F-6 and F-7). Jumpers on TS10 Terminal Strip (Figure F-1) and SW1 position #4 (Figure F-2) on PCB3 (A/N 410338) must be set accordingly; also see Views "B", "C", "D" and Note 2 on Wiring Diagrams. Transformer secondaries may be connected for half wave or full wave rectification.



**For Firing Inside Delta - Use Jumpers #4 as shipped**  
**For Firing Outside Delta & "Y" - Use Jumpers #5**

**Figure F-1. TS10 connections**



**Figure F-2. PCB3 SW1 and L1**

## APPENDIX F EN1003 THREE PHASE DC CONTROLS (cont.)

Correct phase rotation is indicated by the red LED (L1 in Figure F-2) on PCB3 as described in Note 2 on Wiring Diagrams. Incorrect phase rotation or a missing phase will result in LED not being lit.

The control may be operated on 60 Hz or 50 Hz. On PCB3, set SW1 position #3 (Figure F-2) to ON for 60 Hz, OFF for 50 Hz. Also see Note 2 on Wiring Diagrams.

Nominal line voltages of 240 and 480 may be used and selected by jumpers on T8 Transformer (Figure F-3) and TS1 Terminal Strip (Figure F-4) as described in Note 2 on Wiring Diagrams. 380 and 575 volts may also be used, but both require special factory wiring.

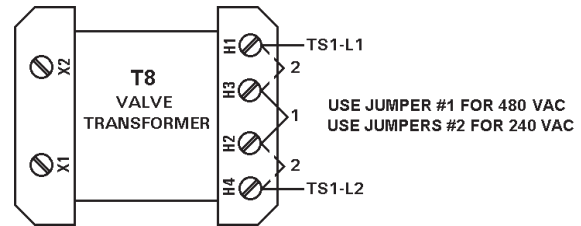
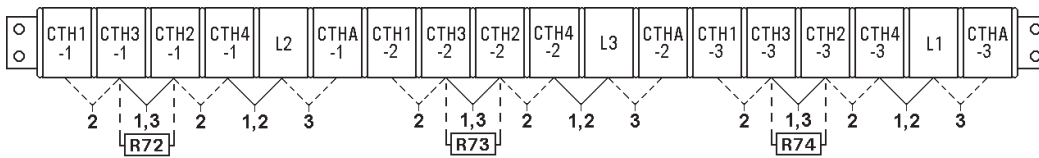


Figure F-3. T8 jumper settings



For 480 VAC Operation - Use Jumpers #1

For 240 VAC Operation - Use Jumpers #2

For 380 VAC Operation - FACTORY WIRED ONLY - Use Jumpers #3

For 575 VAC Operation - FACTORY WIRED ONLY

Use Jumper #1 between CTH4-1 & L2, CTH4-2 & L3, & CTH4-3 & L1.

Jumper #1 between CTH3-1 & CTH2-1, CTH3-2 & CTH2-2, & CTH3-3 & CTH2-3 are removed & replaced by resistors R72, R73, & R74 (2000 Ohm, 10 Watt).

Figure F-4. TS1 jumper settings

If line voltage, frequency, and inside delta, outside delta, or “Y” are specified when ordering the control, it will be set up at the factory as described above.

Six lights on the Front Panel (Figure F-5) indicate power in each phase and voltage across each welding transformer primary.

Three fuses (F1, F2 and F3 – 1/4A) protect the control circuits in each phase. Fuses F6, F7, and F8 (2AG 1A) protect the valve circuits for each of the solenoid valve outputs.



Figure F-5. EN1003 Front Panel

# APPENDIX F EN1003 THREE PHASE DC CONTROLS (cont.)

## 87° DELAY

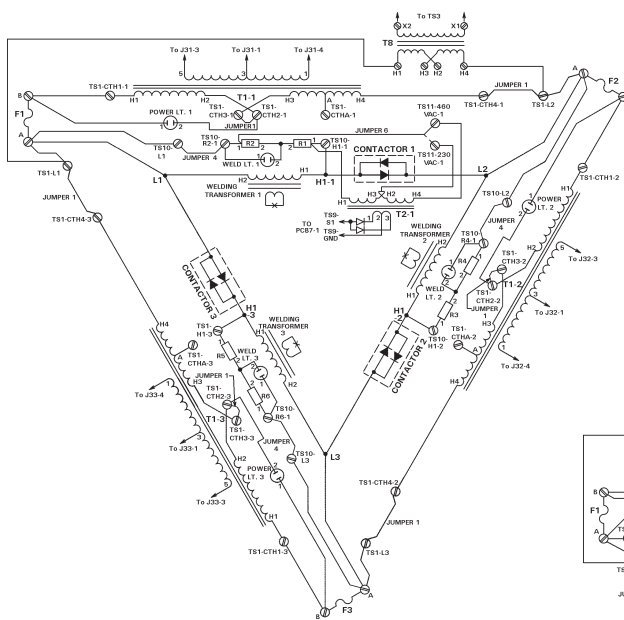
For proper three phase DC operation, the following settings must be made:

1. 87° DELAY must be disabled – **B.7.=00** (see Section 5.4.9)
2. MANUAL POWER FACTOR must be set to **P.P.=99** (see Section 5.4.10)
3. HOLD time must be set to at least 3 cycles

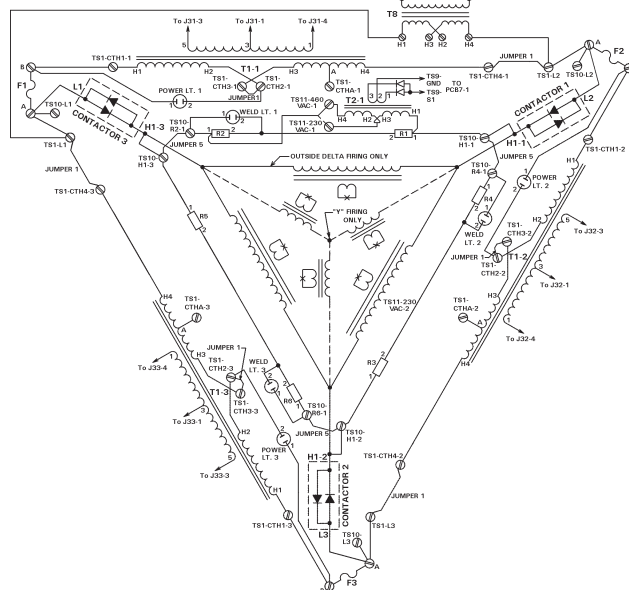
These settings will be made at the factory in new controls, but if Control Board 600541 is replaced for any reason, the customer will need to program these settings into the new board.

To insure proper firing, the control must be programmed with a MANUAL POWER FACTOR setting. Follow the procedure outlined in Section 5.4.11 (Power Factor Measuring). Program this value or any lower value in the EXTENDED FUNCTIONS **P.P.** parameter. In this configuration, 87° DELAY may be left programmed with its default value of **01** (enabled).

When the EN1003 Control is used in the inside delta wiring configuration, each SCR can fire an independent transformer regardless of the secondary configuration.



**Figure F-6.** Inside delta configuration



**Figure F-7.** Outside delta and "Y" configuration



## APPENDIX G EN1000 SERIES RESPONSE TIMES

Some applications require a quick, accurate response from the weld control. In a standard EN1000 Series Control, foot switch debounce time causes an added delay before weld sequence is started. Also the control will always start on the same positive or negative transition of the line, possibly contributing more time before weld sequence is started (see Table G-1 and Figure G-1).

A special firmware PROM has been designed to remove switch debounce delays and the requirement to start on a positive or negative transition of the line. P/N 619016-992 can be obtained when this requirement is needed.

### NOTICE

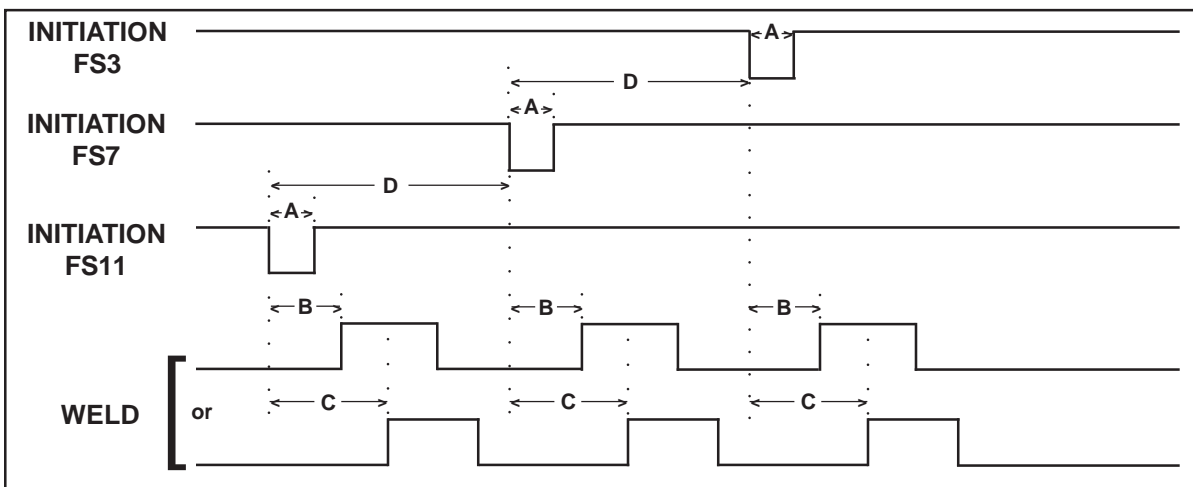
Because of the foot switch debounce removal, Valve 1 and 2 should not be used and Valve 3 should only be used for status indications, as control may start a sequence due to noise. A special Terminal Strip Board has been developed for this use – A/N 410319-015 – with Valve 1 and 2 removed. Also, PS1 will not operate, SQUEEZE must be set to **00**, and SLOPE must not be used. Some Constant Current limit window features may not operate correctly.

For further information, see Wiring Diagram 421180-011 and Table G-1 and Figure G-1.

**P.O. 09** will enable HALF CYCLE mode (see Sections 5.4.7 and 9.8).

**Table G-1.** *Response times*

	Same + or – Line Transition	TIME A	TIME B	TIME C	TIME D
		Minimum Initiation Time that will result in a weld	Minimum Time before Weld starts	Maximum Time before Weld starts	Maximum Repetition Rate SQ=0;W=1;H=0
EN1000 Standard Spot Mode	Yes	12 ms	15 ms	32 ms	60 ms
EN1000 Special Firmware SQ=0;W=1	No	7 ms	3 ms	15 ms	60 ms



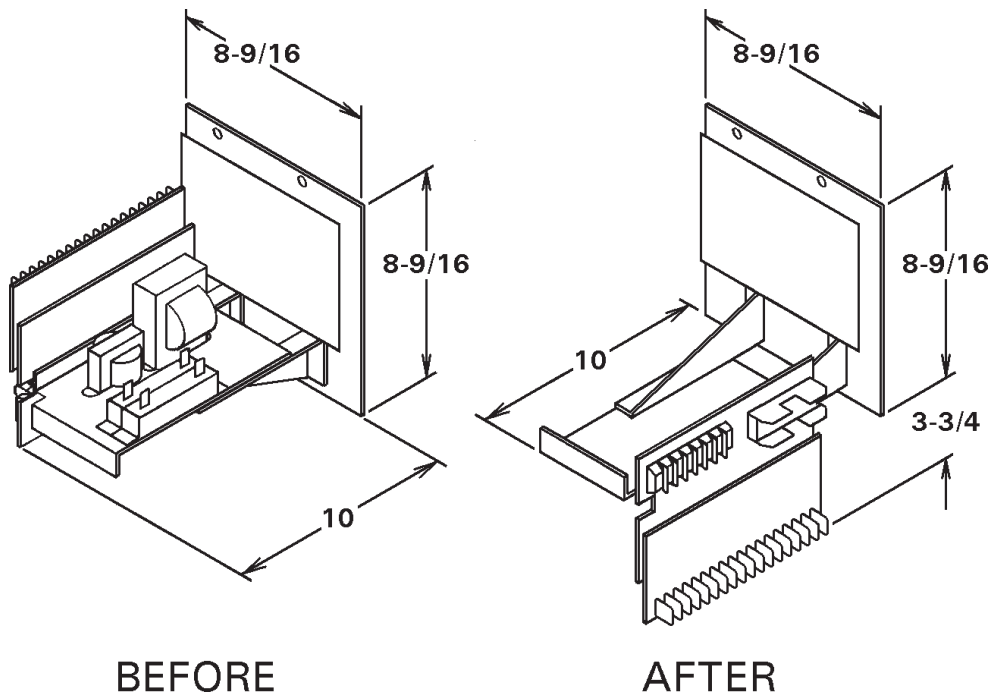
**Figure G-1.** *Response times*

All data in Table G-1 was tested on Sequence Control & Display Board 600572-002 with PROM firmware version 619016-002CC or 619016-992. Worst-case times were recorded. High Speed operation using Binary Select was not tested.

## APPENDIX H IMU MOUNTING OPTIONS

The Integrated Modular Unit (IMU) series of Weld Controls are designed for use in retrofit situations or in new/custom designs. Customers are free to place one or more of these units in existing enclosures or new designs as requirements demand. **To make the IMU even more flexible, the rear chassis can be rotated 180°.** If the IMU as supplied cannot be oriented so that the Terminal Strip/Firing PCB, Voltage Programming Terminal Strip and fuse holder can be accessed directly, the chassis can be inverted (turned upside down) to provide access as shown in Figure H-1. Before installing the IMU in an enclosure, determine whether or not the chassis needs to be flipped. If rotation of the chassis is required, follow the instructions below.

1. Unplug the J2, J3, Weld light and Power light terminal connections, mark the wires for reconnection later.
2. Remove and retain the four 6-32 nuts and split lock washers that attach the IMU mounting brackets to the Dial Plate.
3. Rotate the IMU chassis 180° on its long axis and remount the brackets to the studs on the Dial Plate (see Figure H-1).
4. Extend the J2 and Power light harnesses from their tied-back positions and reconnect all the connections removed above.



**Figure H-1.** *IMU rotation option*

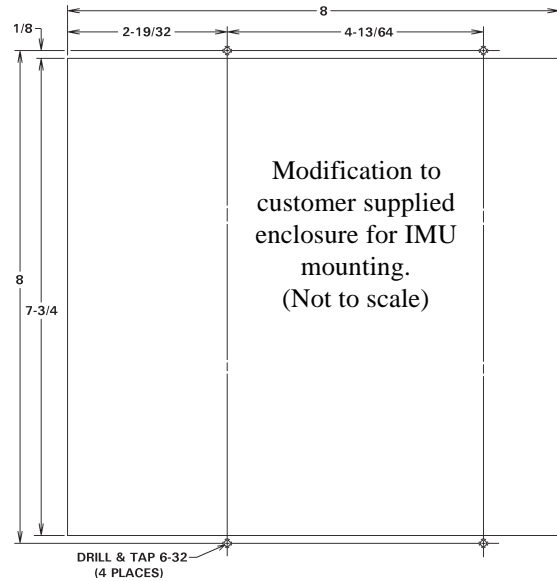
### NOTICE

The standard IMU configuration on the left does not require as much clearance space below the Dial Plate mounting as the new configuration on the right.

## APPENDIX H IMU MOUNTING OPTIONS (cont.)

To install the IMU Control:

1. Modify enclosure to accept IMU per Figure H-2.
2. Mount IMU Assembly to enclosure using four (4) black 6-32 x 1/4 screws supplied in poly bag taped to bottom of IMU.
3. Place supplied precautionary labels on interior or exterior of enclosure as indicated:
  - a. “Danger, Hazardous Voltage from One or More Sources...” Label (P/N 460142)  
Should be placed on interior of enclosure near points of exposed hazardous voltage.
  - b. “Danger, Voltage and Flash Hazard” Label (P/N 460143)  
Should be placed near the fuse.
  - c. “Danger...Earth Ground” Label (P/N 460144)  
Should be placed near customer connection to Earth Ground.
  - d. “Caution, Water Hose Burst Hazard” Label (P/N 460145)  
Should be placed on exterior of enclosure for water-cooled contactors.
  - e. “Warning , Hazardous Voltage from One or More Sources...” Label (P/N 460146)  
Should be placed on exterior of enclosure.
  - f. “Caution, Do Not Pinch Wires...” Label (P/N 460170)  
Should be placed on interior of enclosure.
4. Complete hook-up of wiring to control per Wiring Diagram. See USED ON section below for Wiring Diagram numbers.



**Figure H-2.** *IMU enclosure modification*

### Poly bag taped to bottom of IMU includes:

4 Ea. 6-32 x 1/4 PHSMS, Phil, Black.....	P/N 557004
4 Ea. 6-32 x 1/4 AF Hex Nut .....	P/N 557018
1 Ea. Label, “Danger, Hazardous Voltage...” .....	P/N 460142
1 Ea. Label, “Danger, Voltage and Flash Hazard” .....	P/N 460143
1 Ea. Label, “Danger...Earth Ground” .....	P/N 460144
1 Ea. Label, “Caution, Water Hose Burst Hazard” .....	P/N 460145
1 Ea. Label, “Warning , Hazardous Voltage...” .....	P/N 460146
1 Ea. Label, “Caution, Do Not Pinch Wires...” .....	P/N 460170
1 Ea, Resistor, Power, 2000 Ohm, 10W (For 575V) .....	P/N 600048
1 Ea, Jumper, TS1, 380 VAC Controls .....	P/N 325225

When control is wired for either 230/460/575 VAC Operation, add quantity one (1) TS1 label P/N 460201 for 380 VAC Operation.

When control is wired for 380 VAC Operation, add quantity one (1) TS1 label P/N 460105 for 230/460/575 VAC Operation.

### USED ON:

EN1001-IMU (SCR)	Wiring Diagram 421423
EN1001-IMU/485 (SCR)	Wiring Diagram 421423-002
EN1001/VS-IMU (SCR)	Wiring Diagram 421423-003
EN1000-IMU (SCR)	Wiring Diagram 421424