

# INSTRUCTION MANUAL

700194E

## EN1000/EN1001 CASCADE MULTIVALVE CONTROLS

MICROPROCESSOR BASED  
Welding Controls  
with  
Solid State Thyristor Contactors

Wiring Diagrams

<b>Cabinet Style</b>	<b>EN1000</b>	<b>EN1001</b>
NEMA/FP	421214 series	421438 series

# **ENTRON**

ENTRON Controls, LLC.  
601 High Tech Court  
Greer, South Carolina 29650  
(864) 416-0190  
Fax: (864) 416-0195  
[www.entroncontrols.com](http://www.entroncontrols.com)



# ENTRON Controls, LLC.

## MICROPROCESSOR BASED WELDING CONTROL

INSTALLATION AND OPERATION MANUAL FOR:  
Model Series EN1000/EN1001 CASCADE MULTIVALVE  
NEMA Type: ALL

**READ THIS MANUAL COMPLETELY BEFORE ATTEMPTING  
TO INSTALL OR OPERATE THIS CONTROL**



ENTRON Controls, LLC., reserves the right to alter the contents of this manual without previous notice.

ENTRON Controls, LLC.  
Greer, South Carolina 29650

# TABLE OF CONTENTS

1. GENERAL DESCRIPTION .....	4
1.1 STANDARD FEATURES .....	4
1.2 EN1000/EN1001 CONTROL PANEL LAYOUT .....	6
2. PROGRAMMABLE FUNCTIONS .....	7
2.1 CONTROL FUNCTIONS .....	7
2.2 SEQUENCE TIMED PARAMETERS .....	9
2.3 OTHER PROGRAMMABLE SEQUENCE PARAMETERS .....	10
3. INSTALLATION .....	12
3.1 INSTALLATION DIAGRAMS .....	12
3.2 MECHANICAL MOUNTING DIAGRAM .....	13
3.3 WELDING TRANSFORMER PRIMARY WIRING .....	14
3.4 EXTERNAL SCR CONTACTOR WIRING .....	14
3.5 COOLING REQUIREMENTS FOR CONTACTORS .....	16
4. GENERAL OPERATING REQUIREMENTS .....	17
4.1 OPERATING VOLTAGE .....	17
4.2 FUSING AND SAFE OPERATION .....	19
4.3 TERMINAL STRIP DIAGRAMS AND CONNECTIONS .....	20
4.3.1 TERMINAL STRIP INPUT - 410329 .....	20
4.3.2 TERMINAL STRIP OUTPUT - 410322 .....	21
4.3.3 TERMINAL STRIP CONNECTIONS .....	23
4.4 INITIATION .....	25
4.4.1 INITIATION - SINGLE STAGE .....	25
4.4.2 INITIATION - TWO STAGE .....	25
4.5 OTHER TERMINAL STRIP INPUTS .....	26
4.6 NON-VOLATILE MEMORY ERROR .....	28
4.7 ISOLATION CIRCUITRY DESCRIPTION .....	30
5. INTRODUCTION TO DATA PROGRAMMING .....	32
5.1 GENERAL PROGRAMMING .....	32
5.2 PROGRAM LOCKOUT OPTIONS .....	33
5.2.1 PROGRAM LOCKOUT KEY OPTION .....	33
5.2.2 USING PROGRAM LOCKOUT KEY FOR ERROR CLEARING .....	33
5.3 SEQUENCE PARAMETERS PROGRAMMING .....	34
5.3.1 PROGRAMMING VALVES AND CONTACTORS .....	35
5.3.2 USING PROGRAMMING SHORTCUTS .....	36
5.4 EXTENDED FUNCTIONS .....	37
5.4.1 IDENTIFICATION NUMBER .....	38
5.4.2 SIMULTANEOUS FIRING OF CONTACTORS .....	39
5.4.3 SCHEDULE SELECTION (INT./EXT.) AND ANTI-TIE DOWN .....	40
5.4.4 AUTOMATIC VOLTAGE COMPENSATION AND MONITORING .....	44
5.4.5 CLEAR ALL FUNCTIONS .....	46
5.4.6 BACK-STEP / TEMPERATURE LIMIT SWITCH .....	47
5.4.7 PROCESS OUTPUTS .....	48
5.4.8 BEAT OPERATION -- INITIATION MODES .....	53
5.4.9 87 DEGREE DELAY .....	55
5.4.10 POWER FACTOR PROGRAMMING .....	56
5.4.11 POWER FACTOR MEASURING .....	56
5.4.12 SQUEEZE DELAY .....	57
5.4.13 BLOCKING DELAY .....	57
5.4.14 CONSTANT CURRENT MODES .....	58
5.4.15 RATIO OR RANGE .....	59
5.4.16 CURRENT OFFSET .....	60
5.4.17 PIN LOCKOUT MODE .....	63

6. GENERAL OPERATING INSTRUCTIONS .....	64
6.1 WELD SEQUENCE EXAMPLE .....	64
6.2 CYCLE MODES .....	65
6.2.1 NON REPEAT .....	65
6.2.2 REPEAT .....	66
6.2.3 CHAIN .....	66
6.2.4 SUCCESSIVE .....	68
6.2.5 CONDITIONAL SUCCESSIVE .....	69
6.2.6 WAIT-HERE .....	70
6.3 SLOPE MODES .....	71
6.3.1 NO SLOPE .....	71
6.3.2 UP SLOPE .....	72
6.3.3 DOWN SLOPE .....	72
6.4 VALVE MODES .....	73
7. STEPPER ON EN1000 SERIES CONTROLS .....	74
7.1 SCHEDULE MAP .....	75
7.2 STEPPER PROGRAMMING .....	76
7.3 SCHEDULE INITIATION IN STEPPER MODE .....	78
7.4 STEPPER ALGORITHM .....	79
7.5 STEPPER RESET .....	81
7.6 USING STEPPER AS A COUNTER .....	82
7.7 DISPLAYING STEPPER COUNT DURING OPERATION .....	82
7.8 END OF STEPPER .....	82
8. CONSTANT CURRENT OPERATION .....	83
8.1 INTRODUCTION TO CONSTANT CURRENT OPERATION .....	83
8.2 CONSTANT CURRENT OPERATION WITH PRIMARY SENSOR .....	88
8.3 CONSTANT CURRENT OPERATION WITH SECONDARY HALL-EFFECT SENSOR .....	90
8.4 CONSTANT CURRENT OPERATION WITH SECONDARY SENSOR .....	92
8.5 SENSOR SELECTION JUMPER SETTINGS .....	94
9. APPLICATIONS AND PROGRAMMING EXAMPLES .....	95
9.1 SPOT MODE EXAMPLES .....	95
9.2 SEAM MODE EXAMPLES .....	99
9.3 BRAZING APPLICATION .....	100
9.4 SQUEEZE DELAY APPLICATION .....	101
9.5 RETRACTION APPLICATION .....	102
9.5.1 MOMENTARY CLOSURE - [P.O.]=[08] .....	102
9.5.2 MAINTAINED CLOSURE - [b.S.]=[09] .....	103
9.5.3 AIR OVER OIL RETRACTION - [P.O.]=[07] .....	104
9.6 MULTIPLE SCHEDULE OPERATION .....	109
10. OPTIONS FOR EN1000 AND EN1001 SERIES CONTROLS .....	112
11. ERROR CODES AND TROUBLESHOOTING .....	114
11.1 ERROR CODES .....	114
11.2 TROUBLE SHOOTING .....	116
11.3 TROUBLE SHOOTING GUIDE .....	118
11.4 BLOCK DIAGRAM .....	120
12. WARRANTY AND SERVICE .....	121
APPENDIX A - ERROR CODES LIST .....	122
APPENDIX B - INTRODUCTION TO PROGRAMMING EN1000 SERIES CONTROLS .....	123

# 1. GENERAL DESCRIPTION

The EN1000/EN1001 Cascade Control is a microprocessor based welding control. It can perform Up Slope, Down Slope, Quench, Temper, Pulsation, Seam, and Spot, with standard eight Valve Outputs (and additional 8 as option), all of which can be combined to provide for any possible welding schedule imaginable. It can store as many as 12 base parameters in each of 100 unique schedules. These are held in non-volatile memory for storage. In addition, schedules can be chained together to provide more complex welding sequences. Despite the seemingly complicated possible welding schedules, both the EN1000 and EN1001 Cascade Multivalve controls are simple to program and operate.

The control provides accurate, predetermined execution of welding schedules for specific numbers of cycles upon an external command. Initiation commands can be given by the closure of a normally-open switch installed as part of the welding machine. The initiation switches need not remain closed for the duration of the weld, but must be opened after the welding interval is completed in order to re-initiate the control. After a weld has been started, the control cannot be re-initiated until the previous sequence is completed.

The EN1000/EN1001 Cascade control is designed to operate in conjunction with a welding transformer rated for the 60 Hz or 50 Hz output frequency. These controls can be used either on 60 Hz or 50 Hz, without any additional settings or changing parameters. These control are not designed to operate with mid-frequency inverter transformers with 500 Hz to 2000 Hz operating frequency rating.

The EN1001 differs from EN1000 as it has a Constant Current mode of operation, see Section 5.4.14 and Section 8.

## 1.1 STANDARD FEATURES (All Models)

**DIGITAL PHASE SHIFT CURRENT CONTROL** - varies the output waveform duty cycle from 0 percent to 99 percent, adjustable in one percent steps by means of front panel push-buttons and direct reading LED displays.

**FUNCTION TIMING** - Control uses front panel push-button switches and direct reading LED displays to program parameter timing in 1 cycle steps. Timing of Squeeze, Hold, Off are achieved by counting each cycle of the line current directly. This method of timing allows this control to be used on either 50 Hz or 60 Hz power without special adjustments.

**NOTE: NO ADJUSTMENT** is required for timing to change from 60 to 50 Hz operation.

**OPERATING CONDITIONS** - Temperature Range: 0°C to 70°C (32°F to 158°F).

**POWER SUPPLY MONITORING** - Control monitors VCC power supply, and whenever this voltage goes below safe operating range, the message [*d.o.u.n.*] will be displayed on DATA displays. After this condition, Control must be reset by activating ES input, or by re-applying the power to the Control.

**PRESSURE SWITCH FIRING** - terminal strip connection allows the control to be initiated from a pressure switch closure. Remove the jumper from TS1-PS1 and TS1-GND and connect pressure switch leads. Pressure switch is not furnished with control.

**EMERGENCY STOP** - This is a terminal strip connection that allows all control functions to be reset upon opening of the EMERGENCY STOP switch. **After an emergency stop, the control will not re-initiate automatically upon release of the switch.** The control must be re-initiated through the initiation circuits. Remove the jumper from TS1-ES1 and TS1-GND and install a normally closed switch. EMERGENCY STOP switch is not furnished with control.

**VALVE CONTROL TRANSFORMER** - This transformer provides the necessary voltage for powering the welding machine solenoid valve(s). Input voltage may be either 240 VAC or 480 VAC, or optional 575 VAC (see Customer Wiring Diagram). Valve transformer output is 115 VAC (Optional low voltage transformer for certain operations provides a 24/48 VAC output). A 150VA transformer is standard in all Cabinets (250VA or 500VA transformers optional).

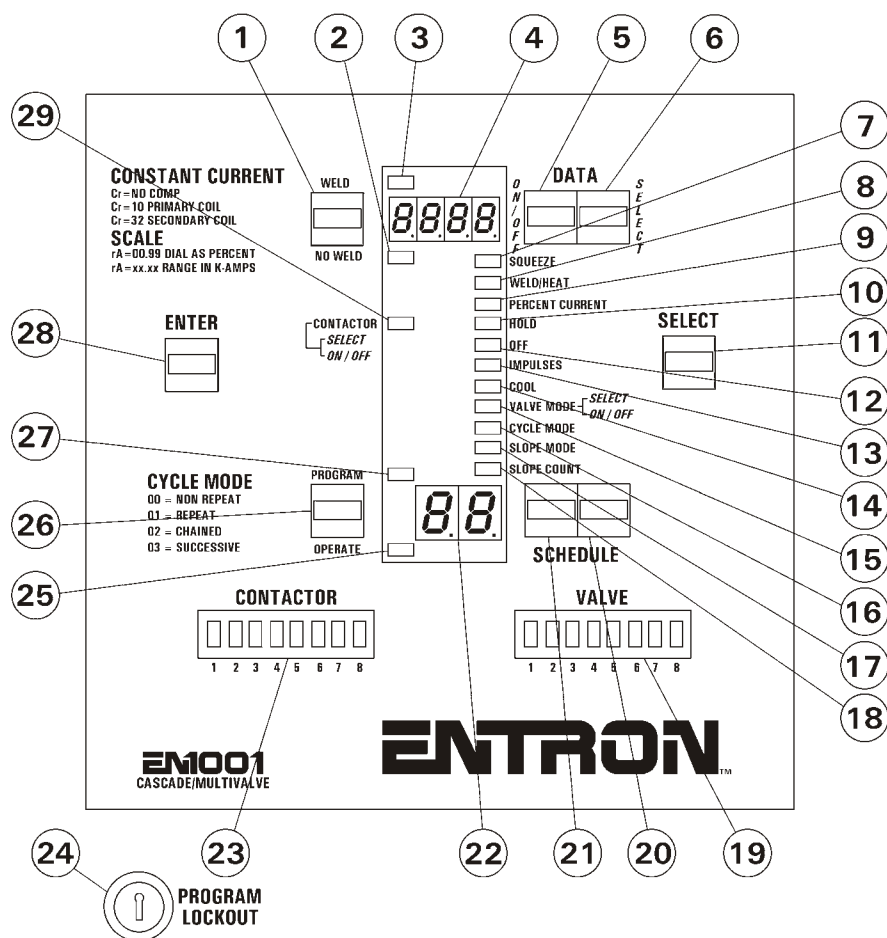
**NOTE:** This control may be configured for external valve power. See Section 4.3 for terminal strip (TS10 or TS15) external valve power connection.

**CAUTION**

When external valve power is used, 24-240VAC or 24VDC, Valve Transformer must be disconnected at TS-VL1 and TS-VL2.

Caution must be used to properly insulate the wires from X1 and X2 leads after removing from TS10 on A/N 410322 or TS15 on A/N 410322-001.

## 1.2 EN1000/EN1001 CASCADE CONTROL PANEL LAYOUT



**Figure 1.** Front Panel EN1000/EN1001 Cascade Multivalve layout

- |  |   |
|--|---|
| 1 - WELD/NO WELD SWITCH                    | 16 - INDICATOR LED, CYCLE MODE FUNCTION*    |
| 2 - INDICATOR LED NO WELD MODE             | 17 - INDICATOR LED, SLOPE MODE FUNCTION     |
| 3 - INDICATOR LED WELD MODE                | 18 - INDICATOR LED, SLOPE COUNT FUNCTION    |
| 4 - DATA DISPLAY                           | 19 - LED INDICATORS, VALVE                  |
| 5 - INCREMENT DATA 10'S PUSH-BUTTON        | 20 - INCREMENT SCHEDULE 1'S PUSH BUTTON     |
| 6 - INCREMENT DATA 1'S PUSH-BUTTON         | 21 - INCREMENT SCHEDULE 10'S PUSH BUTTON    |
| 7 - INDICATOR LED, SQUEEZE FUNCTION        | 22 - SCHEDULE SELECT DISPLAY                |
| 8 - INDICATOR LED, WELD/HEAT               | 23 - LED INDICATORS, CONTACTOR              |
| 9 - INDICATOR LED, PERCENT CURRENT         | 24 - PROGRAM LOCKOUT SWITCH                 |
| 10 - INDICATOR LED, HOLD FUNCTION          | 25 - INDICATOR LED, CONTROL IN OPERATE MODE |
| 11 - FUNCTION SELECTION PUSH BUTTON SWITCH | 26 - PROGRAM/OPERATE PUSH BUTTON            |
| 12 - INDICATOR LED, OFF FUNCTION           | 27 - INDICATOR LED PROGRAM MODE             |
| 13 - INDICATOR LED, IMPULSES FUNCTION      | 28 - ENTER PUSH BUTTON SWITCH               |
| 14 - INDICATOR LED, COOL FUNCTION          | 29 - CONTACTOR SELECT LED                   |
| 15 - INDICATOR LED, VALVE MODE FUNCTION    |   |

\* For operator convenience, codes for Cycle mode functions are printed on the left side of the control panel, below the ENTER push-button. On the **EN1000** Control Panel layout there is no added text for clarification of Constant Current modes.



## 2. PROGRAMMABLE FUNCTIONS

**SCHEDULES** - The EN1000/EN1001 Cascade Multivalve controls can store up to 100 schedules. A weld sequence may include more than one schedule. A chain of schedules, for example, may be used to add a forge operation during a weld sequence, or add a quench and temper sequence to a schedule. In the simplest form, a weld schedule may include SQUEEZE, WELD, and HOLD only. In a more complex form, a schedule may include: SQUEEZE and PRESSURE or FORCE for the electrode, WELD time and STEPPER count, CURRENT in [%] or [kA] and CURRENT LIMITS HI or LO when using Constant Current Mode, HOLD, etc. All of these features may be accessed by means of front panel parameters.

**EXTENDED FUNCTIONS** - The Extended Functions are used instead of Jumper or Dip-switch settings. They are accessible from the front panel. To access the Extended Functions, simply click the SELECT push-button until the indicator LED reaches Slope Count, then click once more. At this point the top display will show [EF]. By clicking the SCHEDULE Push-Buttons, the extended functions are visible in the bottom display. For most features, such as Chaining schedules, or Successive initiations, it is not necessary to enable functions, for some others, it is necessary to just enable a front panel accessible Extended Function such as the Stepper, [5.1.]. For others, it is necessary to add optional hardware to the base control, such as the Integrated Pressure Sense Control System or Constant Current operation.

### 2.1 CONTROL FUNCTIONS - See Figure 1, CONTROL PANEL LAYOUT

**WELD/NO-WELD BUTTON (1)** - This push-button is active at all times. It puts the control in the WELD MODE (enables the weld firing pulse) or NO-WELD MODE (disables firing). This function is accessible while in operate mode or while welding with few exceptions (generally during error conditions).

**INDICATOR LED WELD (3)/NO-WELD (2)** - These lights indicate the firing status of the control. The LEDs toggle whenever the WELD/NO-WELD SWITCH is pressed.

**DATA PUSH-BUTTONS (5) & (6)** - The right button increments by one, and the left button increments by ten. When either digit reaches the maximum, it resets to zero (Only active in the program mode).

**INDICATOR LED (7-10, 12 -18, and 29)** - The indicator LEDs light up to indicate the active schedule parameter. They correspond to the programmable functions listed on the panel as the operator presses SELECT to view function values.

**SELECT (11)** - Use the SELECT push-button to choose any schedule parameter. As the button is pressed the corresponding LED will light up to indicate the parameter data in the "DATA" display. Holding the SELECT button momentarily will reverse the direction of the LED movement when the button is released.

**EXTENDED FUNCTIONS:** One of the features found while scrolling through the functions by using the SELECT push-button, is the EXTENDED FUNCTIONS [EF]. The Extended Functions are a second layer of parameters that apply to all the schedules, and can modify or enhance the way the control operates. See section 5.4 Extended Functions. To view the EXTENDED FUNCTIONS, press SELECT until all the LEDs are off, and the DATA display shows [ EF ]. Use SCHEDULE push-buttons to scroll through EF parameters.

## 2.1 CONTROL FUNCTIONS - Continued - See Figure 1, CONTROL PANEL LAYOUT (Page 6)

**SCHEDULE DISPLAY (22)** - The SCHEDULE DISPLAY shows the number of the active SCHEDULE. The EN1000/EN1001 Cascade can store up to 100 schedules [ 00 to 99 ].

**SCHEDULE PUSH-BUTTONS (20) & (21)** - The **right** button **increments** SCHEDULE by **one**, and the **left** button **increments** SCHEDULE by **ten**. When either digit reaches the maximum, it resets to zero.

There are two ways to select the active SCHEDULE:

1. **INTERNAL:** Use the SCHEDULE push-buttons and **select** the desired SCHEDULE. Initiation on FS3 to GND will select the schedule shown in the display. See EXTENDED FUNCTIONS Section 5.4.3 - [**5.5.**] = 00.
2. **EXTERNAL:** Use a combination of FS7/SS1 AND FS11/SS3 to **select one of four schedules**. See EXTENDED FUNCTIONS section 5.4.3. - [**5.5.**] = 01.

**PROGRAM/OPERATE PUSH-BUTTON (26)** - will put the control in the PROGRAM or OPERATE mode. LED indicators (25) and (27) indicate which mode the control is in.

PROGRAM mode is the mode in which the individual schedules can be entered or modified. **DATA such as weld time, percent of current, valve select, etc. can only be changed in the PROGRAM MODE.**

OPERATE mode is the normal operating mode for the control. This is the only mode in which the control can be initiated for a weld. When the control is in OPERATE mode, the control is in a "Ready" (to initiate) state.

### PROGRAM LOCKOUT SWITCH (24) (Optional)

A PROGRAM LOCKOUT key switch can be ordered as a factory installed option. It may also be added later by the customer, if desired. To install the key switch, remove the key switch hole-plug from the cabinet and mount the switch using the nut and lock-washer provided. Connect the plug from the switch onto the mating 2-prong connector (J1) on the back of the display circuit board.

To put the control in the **PROGRAM** mode using the PROGRAM LOCKOUT Switch:

**Rotate the key 45 degrees clockwise and hold, while holding the key in this position, press and release the PROGRAM/OPERATE push-button**, then release the key. The OPERATE LED will now turn off and the PROGRAM LED will turn on, indicating programmability of all functions.

To put the control back in the **OPERATE** mode:

Press the PROGRAM/OPERATE push-button again. The control will return to the OPERATE Mode without the necessity of rotating the key.

**NOTE:** See Section 5.4.17 for detailed information on PIN Lockout Mode.

## 2.1 CONTROL FUNCTIONS - Continued - See Figure 1, CONTROL PANEL LAYOUT (Page 6)

**ENTER (29)** - The ENTER push-button is used to STORE the data shown, FROM the DATA Display INTO the non-volatile MEMORY. (The non-volatile memory retains data with the power OFF). **If ENTER is NOT pressed before other DATA is viewed (by pressing the SELECT push button) or before returning to the OPERATE mode, the DATA will not be stored, however, it is not necessary to press the ENTER (29) push-button to save the four digit display .**

**VALVE LED'S (19)** - The LEDs under the word "VALVE" (small lower right window), indicate which valves will be used in the current schedule. VALVE LEDs will turn on either when the "VALVE" schedule parameter is SELECT or during the execution of a welding schedule. Codes for Valve selection are given in Table 2.1.

NOTES ON VALVES: The control can activate **any or all of eight solenoid valves** available on the standard valve output board. **The programming of the valves is done by choosing a schedule and then turning valve LEDs on.** Since this is done visually, there are no codes to memorize or follow. The corresponding valves will turn on according to the pattern shown.

While in the OPERATE mode, and while viewing the current VALVE setup, the DATA display will show the hexadecimal (hex) representation of the pattern seen in the VALVE display, digits 1 through 16 will show as [ 1 2 3 4 5 6 7 8 9 a b c d e f ].

**CONTACTOR LED'S (23)** - The LEDs under the word "CONTACTOR" (small lower left window), indicate which contactor will be used in the current schedule. It will turn on either when the indicating LED stops at "CONTACTOR SELECT" while viewing parameters or at the time of firing a transformer, during the execution of a weld sequence.

NOTES ON CONTACTORS: The control **can activate one of up to eight contactors per schedule.** The programming of the contactors is done by choosing a schedule and then turning the chosen contactor LED on. Since the programming is done visually, there are no codes to memorize or follow. The corresponding contactor will fire during the execution of the schedule it is assigned to. See section 6.2 on chain mode for cascade weld operation.

While in the OPERATE mode, and while viewing the current CONTACTOR setup, the DATA display will show the hexadecimal (HEX) representation of the pattern seen in the CONTACTOR display, digits 1 through 16 will show as [ 1,2,3,4,5,6,7,8,9,a,b,c,d,e,f ].

See also Section 5.4.2 for Simultaneous Contactors Firing.

## 2.2 SEQUENCE TIMED PARAMETERS (Count Functions)

PARAMETER	RANGE	Factory default setting
SQUEEZE	00 to 99 cycles	00
WELD /HEAT	00 to 99 cycles	00
HOLD	00 to 99 cycles	00
OFF	00 to 99 cycles	00
IMPULSES	01 to 99 impulses	01
COOL	00 to 99 cycles	00
SLOPE COUNT	00 to 99 cycles	00

NOTE: **NO ADJUSTMENT** is required for timing to change from 60 to 50 Hz operation.

**SQUEEZE COUNT (7)** - The **time duration for the electrodes to close** on the work and build up pressure **before WELD** time begins.

**WELD/HEAT COUNT (8)** - The **time during which current will flow through the welding transformer** (during one impulse in impulse welding ). It **starts after squeeze** or after the closure of a pressure switch, whichever occurs last.

**HOLD COUNT (10)** - The **time during which the electrodes will remain in contact** with the work to allow the weld nugget to congeal. It starts **after the weld time**.

**OFF COUNT (12)** - In the Repeat mode, the time duration between HOLD Count and SQUEEZE Count to allow the work to be repositioned.

**COOL COUNT (14)** - The **time between heat impulses** (in multiple impulse welding).

**SLOPE COUNT (18)** - The **number of additional weld cycles** during which the **percent current increases or decreases** to achieve a SLOPE, gradual increase or decrease in current.

### 2.3 OTHER PROGRAMMABLE SEQUENCE PARAMETERS

**IMPULSES (13)** - The number of HEAT IMPULSES that will occur in a schedule.

**PERCENT CURRENT (9)** - The PERCENTAGE of conduction time provided to the welding transformer primary from 0 to 99 percent, adjustable in 1% steps.

**VALVE MODE (15)** - The eight solenoid valves are activated based on the code programmed as shown in Table 2.1.

Table 2.1 *Valve Codes*

Valve Code right digit	Valves LED 4 3 2 1	Description	Valve Code left digit	Valves LED 8 7 6 5	Description
00	0 0 0 0	Four valves off	00	0 0 0 0	Four valves off
01	0 0 0 1	Valve 1	10	0 0 0 1	Valve 5
02	0 0 1 0	Valve 2	20	0 0 1 0	Valve 6
03	0 0 1 1	Valves 1 & 2	30	0 0 1 1	Valves 5 & 6
04	0 1 0 0	Valve 3	40	0 1 0 0	Valve 7
05	0 1 0 1	Valves 1 & 3	50	0 1 0 1	Valves 5 & 7
06	0 1 1 0	Valves 2 & 3	60	0 1 1 0	Valves 6 & 7
07	0 1 1 1	Valves 1,2 & 3	70	0 1 1 1	Valves 5,6 & 7
08	1 0 0 0	Valve 4	80	1 0 0 0	Valve 8
09	1 0 0 1	Valves 1 & 4	90	1 0 0 1	Valves 5 & 8
0a	1 0 1 0	Valves 2 & 4	a0	1 0 1 0	Valves 6 & 8
0b	1 0 1 1	Valves 1,2 & 4	b0	1 0 1 1	Valves 5,6 & 8
0c	1 1 0 0	Valves 3 & 4	c0	1 1 0 0	Valves 7 & 8
0d	1 1 0 1	Valves 1,3 & 4	d0	1 1 0 1	Valves 6,7 & 8
0e	1 1 1 0	Valves 2,3 & 4	e0	1 1 1 0	Valves 6,7 & 8
0f	1 1 1 1	Valves 1,2,3, & 4	f0	1 1 1 1	Valves 5,6,7, & 8

When in the PROGRAM mode and selection of a valve code is being made, the valve LED indicators (19) will indicate the selected valve (s). The valve output will not be energized while in program mode.

**NOTE:** Beside the standard **eight** Valve Outputs, which valve code are indicated in the Table 2.1, there is one more valve output used for PROCESS OUTPUT. See section 5.4.7 in Extended Functions section.

**CYCLE MODE (16)** - The manner in which the control performs schedules is determined by the code programmed into this function as follows:

CYCLE MODE	MODE	Description
00	NON-REPEAT	The control can be initiated for only one sequence.
01	REPEAT	After initiation, the control <b>internally re-initiates</b> as long as the <b>initiation switch</b> is maintained <b>closed</b> .
02	CHAINED	Several schedules can be "chained" together so that several consecutive schedules can be sequenced from <b>one initiation</b> .
03	SUCCESSIVE	In the SUCCESSIVE mode several schedules can be sequenced successively upon <b>separate initiations</b> .
04	CONDITIONAL SUCCESSIVE	Valves remains active at the end of HOLD ( <i>this is indicated by blinking the front panel HOLD LED</i> ), until control is re-initiated and next schedule will be sequenced.
05	WAIT-HERE	After FS3 initiation, wait either in SQUEEZE or WELD-COOL or HOLD part of the sequence, until control is re-initiated with FS7 or FS11 and schedule 10 or 20 will be sequenced.

**NOTE:** See Section 6.2 for detailed information on Cycle Mode Functions.

**NOTE:** The CONSTANT CURRENT, CYCLE and SLOPE mode and function selection codes are printed on the left upper and lower corner of the control panel, adjacent to the ENTER push button (26) for operator convenience.

**SLOPE MODE (17)** - Determines the DIRECTION of the ramp with respect to the programmed weld percent current.

SLOPE MODE	Description
00	<b>NO SLOPE</b>
01	<b>UP SLOPE</b>
02	<b>DOWN SLOPE</b>

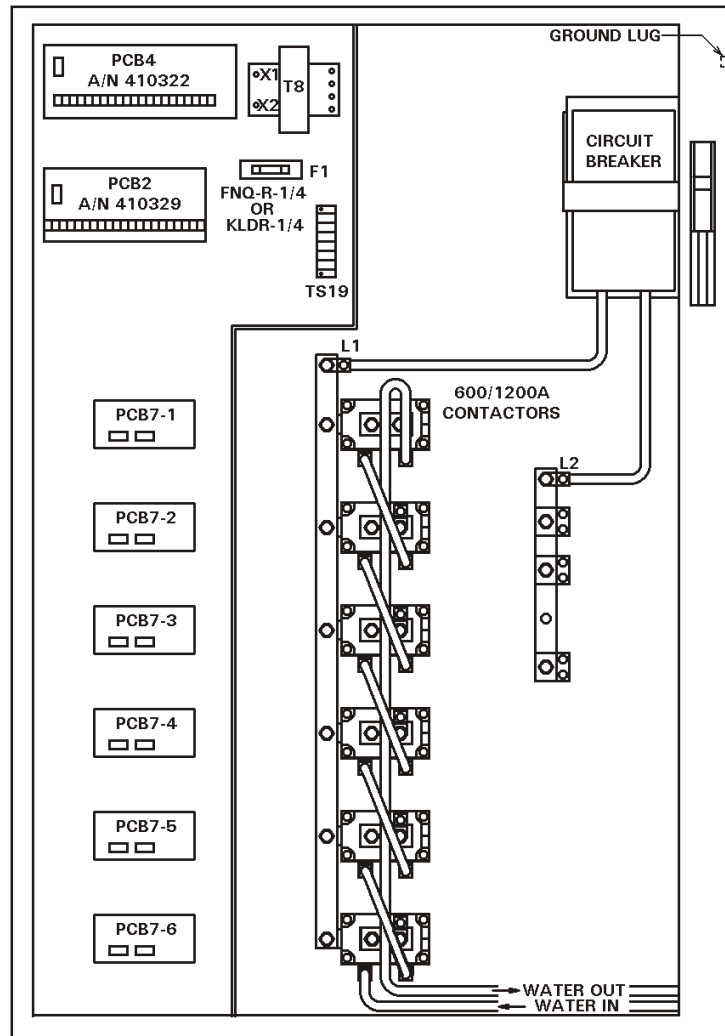
**NOTE:** See Section 6.3 for detailed information on Slope Mode Functions.

### 3. INSTALLATION

The EN1000 and EN1001 Cascade controls can be provided in different cabinet style with different number of SCR contactors from 1 to 8.

#### 3.1 INSTALLATION DIAGRAMS

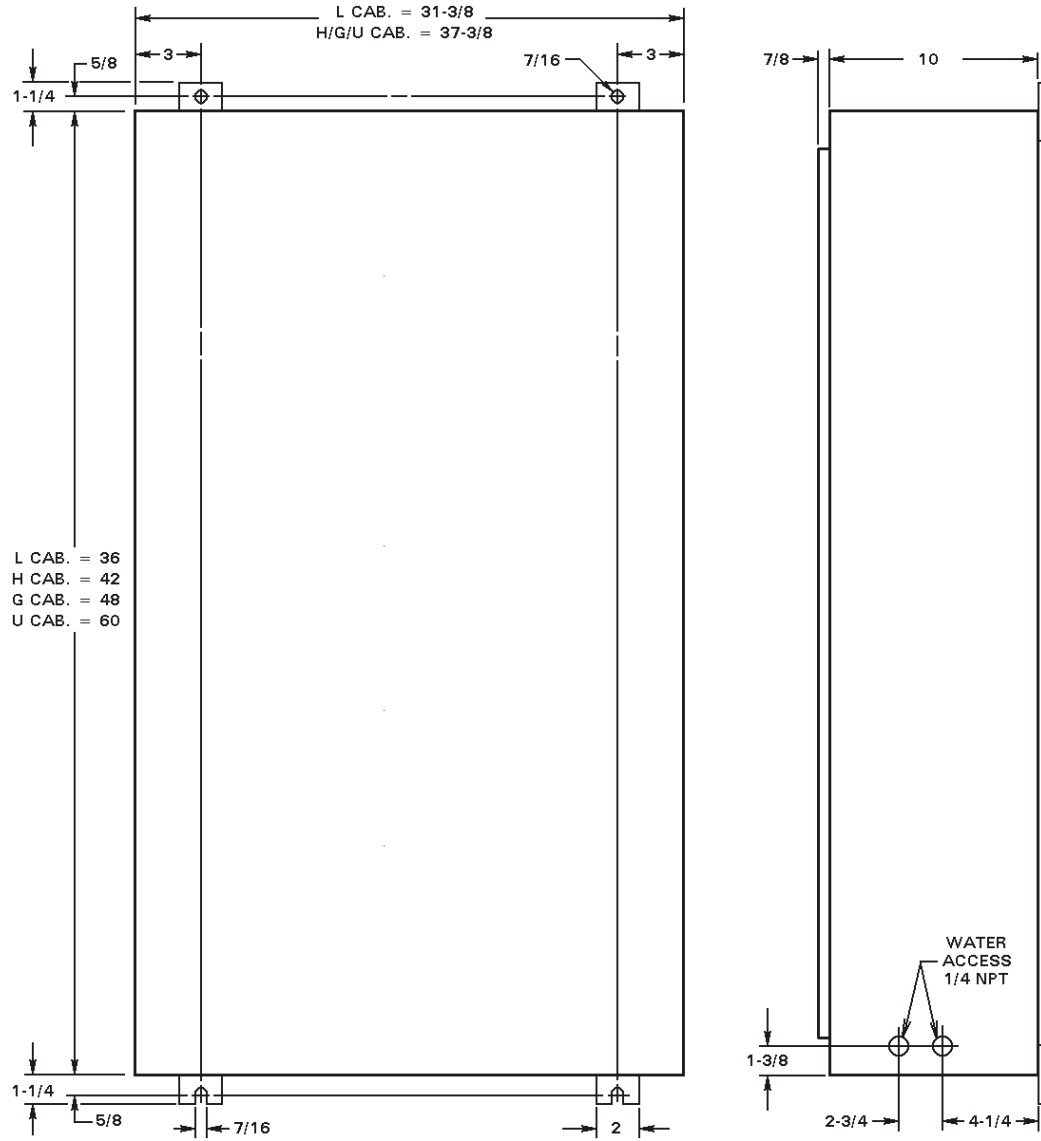
Example of G Style Cabinet with 6 SCR contactors is shown on the Figure 3.1.1.



**Figure 3.1.1** Style G Cabinet - 600/1200 A

**NOTE:** See Section 3.2 for more information about mounting.

### 3.2 MECHANICAL MOUNTING DIAGRAM L/H/G/U CABINETS



**Figure 3.2.1** Mechanical mounting diagram

### 3.3 WELDING TRANSFORMER PRIMARY WIRING

#### SCR OR IGNITRON TUBE CONTACTORS

##### WARNING

When power is ON, all exterior surfaces of the ignitron tubes and SCR's carry line voltages of 240 V or 480 V (or 575 V). Contact with these devices may cause serious or fatal injuries.

1. For your convenience, many electrical and mechanical connections have been performed at the factory. Check **ALL** electrical connections to ensure that all connections are tight. Connections may loosen during shipping.
2. Connect the L1 lead from incoming power to the L1 connection located on the contactor assembly. Connect the H1 lead from the welding transformer to the H1 connection located on the contactor assembly. Follow machine manufacturer's recommended wire size for installation. A connection from L2 must be made to TS1- XH2/L2 to provide power to the control circuitry. Refer to the CUSTOMER WIRING DIAGRAM for other connections.
3. When control is supplied with a circuit isolation device, L1 is factory installed and the L2 control wire is connected to TS1-XH2/L2.

**NOTE:** Connect a CHASSIS GROUND to the lug provided on the right wall of the control cabinet and to an external earth ground. **A good earth ground is necessary for proper control operation.**

### 3.4 EXTERNAL SCR CONTACTOR WIRING

External SCR Contactor wiring is shown on Figure 3.4.1. Connectors J5 and J6 are mounted on Firing Board PCB 7. Connector TS12 is located on EN1001 Control Board.

TERMINAL	CONNECTION DESCRIPTION
TS11-L1	Connect to contactor L1 terminal.
TS11-XH1	Connect to contactor H1 terminal.
TS11-XH2	Connect to circuit isolation device L2 or H2.
J5-C	Connect to the cathode of SCR1.
J5-G	Connect to the gate of SCR1.
J6-C	Connect to the cathode of SCR2.
J6-G	Connect to the gate of SCR2.
TS12	Connect to the current coil, <i>EN1001 only</i> .
TS12	Connect to the current coil, <i>EN1001 only</i> .

For more information refer to one of the Customer wiring diagrams 421214 or 421438 for particular Cabinet style.

**NOTE:** Do not over tighten TS8, TS9, J5 or J6.





## 3.5 COOLING REQUIREMENTS FOR CONTACTORS

### SOLID STATE MANUFACTURER'S COOLING RECOMMENDATIONS

600 A - SCR Solid State Contactor  
1200 A - SCR Solid State Contactor  
1800/2200 A - SCR Solid State Contactor

1 GPM at 104°F (40°C) maximum inlet temperature.

Be sure power to an electronic contactor is turned off when water is turned off.

With a voltage applied, most water will ionize and begin to conduct current between points of high differential voltages. This current is sufficient to heat the water past the boiling point, creating steam and possibly causing the rubber hose to burst. The water spraying over the high voltage circuit can cause considerable damage to the contactor and, most likely, the control circuitry as well. Never use metallic or other conductive tubing to plumb a water cooled resistance welding contactor. Heater hose has a very high carbon content and should not be used for contactor plumbing. A low carbon, reinforced hose (such as the hose originally supplied with the unit), no less than 18" long, must be used to connect the heat sinks to each other and to the bulkhead fitting on the inside wall of the cabinet, see plumbing instructions on wiring diagram.

The EN1000 water cooled SCR contactors are electrically isolated from the electrical circuit within the contactor section. No minimum length of water hose is required for electrical isolation of the contactor. It is still recommended to turn power off when the control is not in use.

**WATER OFF - POWER OFF  
POWER ON - WATER ON**

For all water cooled heatsinks, be sure water is turned ON before placing welder in operation. An open drain is recommended for best operation. If a closed return system is used, be sure return line is properly sized so that back pressure will not reduce water flow below recommendations. A sight flow indicator is recommended.

## 4. GENERAL OPERATING REQUIREMENTS

### 4.1 OPERATING VOLTAGE

To insure the control will operate properly, it must be properly grounded. Proper grounding is not only a safety precaution, it will lessen the possibility of electrical interference being introduced into the control. Ground the control at the ground lug on the cabinet.

**CAUTION: THIS WELDING CONTROL OPERATES ON SINGLE PHASE 208VAC, 240VAC, 380VAC, 480VAC OR 575VAC.**  
**When the Welding Control and/or Welding Machine is shipped, the Voltage at which it was set is marked on the tag attached to the Control terminal block.**

#### WARNING:

THIS CONTROL IS A MULTI-VOLTAGE UNIT WHICH CAN BE CHANGED FROM ONE VOLTAGE TO ANOTHER BY RE-ARRANGING JUMPERS ON THE TERMINAL STRIP FOUND INSIDE THE UNIT. If the Control is used on a voltage other than the one for which it is wired, serious damage can result.

It is possible to operate the EN1000 Series control at 208, 240, 380, 480, and 575 VAC. When a 380 or 575 VAC main is desired, please consult the factory. When the control is converted from one line voltage to another, there are three changes required.

1. **Control Transformer:** Jumpers on TS1-CTH1, TS1-CTH3, TS1-CTH2, and TS1-CTH4 must be configured to match the line voltage. For TS1 Wiring, see Figure 4.1.1.

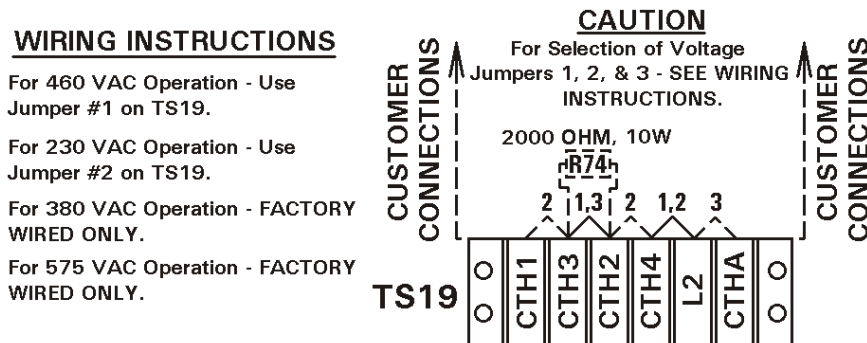


Figure 4.1.1 Voltage Operation jumpers settings

2. **Sense Transformer:** Jumpers on TS1-H1, TS1-H3, TS1-H2, and TS1-H4 must be configured to match the line voltage. For TS1 Wiring, see Figure 4.1.1.

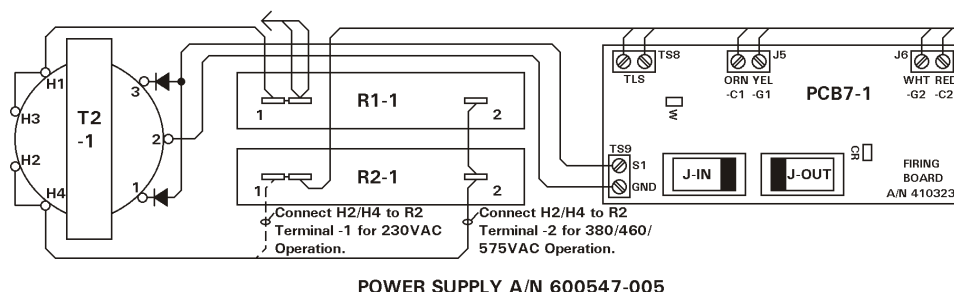


Figure 4.1.2 Sense Transformer jumpers settings

3. **Valve Transformer:** Jumpers on the valve transformer H1, H3, H2, and H4 must be configured to match the line voltage, Figure 4.1.3. The standard valve transformer included with the EN1000/EN1001 (either 50 VA or 150 VA) is configured for 240VAC or 480VAC input, for 380 or 575 VAC operation, consult the factory.

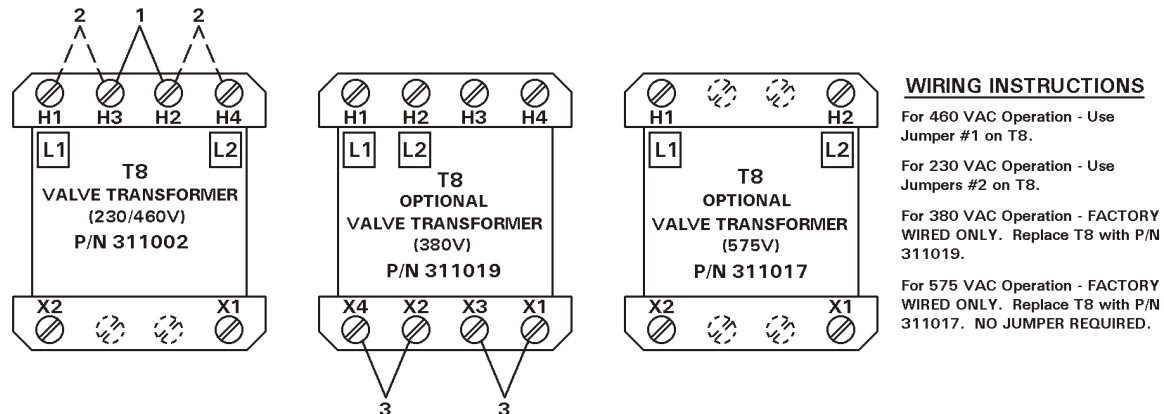


Figure 4.1.3 Valve Transformer jumper settings

**WARNING**

**When external valve power is used (24-240 VAC). Valve transformer MUST be disconnected at TS10-VL1 and TS10-VL2.** Caution must be used to properly insulate the wires from X1 and X2 leads after removing them from TS terminals.

**NOTE:** Whether valve power is supplied by the Valve transformer or by an external valve power supply, the maximum current that can be switched by the solid state relays on the Firing Board is max 1 A per valve. If more current is desired, the valve circuit should be wired to an external relay having a suitable contact rating to switch the desired valve. For more information, refer to CUSTOMER WIRING DIAGRAM shipped with the control.

**JUMPER SETTINGS EXAMPLES:**

**240 Volt Operation Jumpers**

Customer Terminal Strip TS1:

- Jumper H1/H3 and H2/H4
- Jumper CTH1/CTH3 and CTH2/CTH4

Valve Transformer:

- Jumper H1/H3 and H2/H4

**480 Volt Operation Jumpers**

Customer Terminal Strip TS1:

- Jumper H3/H2
- Jumper CTH3/CTH2

Valve Transformer:

- Jumper H3/H2

## 4.2 FUSING AND SAFE OPERATION

- CONTROL FUSE -** This fuse, a 1/4 A, is used to protect the control circuits. The fuse holder is located within the Control, upper left section of the cabinet.
- VALVE FUSES -** These fuses, a 2AG 1 A, are used to protect the valve circuits. These nine fuses are located on the TERMINAL STRIP OUTPUT PCB, A/N 410322, within the Control.
- IGNITOR FUSES -** These fuses, BAF 6 A, two per contactor (supplied with ignitron tube retrofit controls only), are used to protect the ignitor circuits of the ignitron tubes. The fuse holders are located on the IGNITRON FIRING BOARD MODULE PCB8, A/N 410318.

**CAUTION:**  
 INSTALL PROPERLY SIZED FUSES IN SERVICE DISCONNECT SWITCH. CHECK WELDING MACHINE MANUFACTURER'S RECOMMENDATIONS.

**WARNING:**  
 VOLTAGES PRESENT IN THIS CONTROL CAN CAUSE SEVERE OR FATAL INJURY. DO NOT SERVICE ANY COMPONENT WITH POWER "ON".  
 USE ONLY THE FUSE TYPE SPECIFIED TO MAINTAIN SAFE OPERATION.

Observe the **WARNING**, **DANGER** and **CAUTION** labels affixed to the control to maintain safe operation. Some of them are shown on the Figure 4.2.

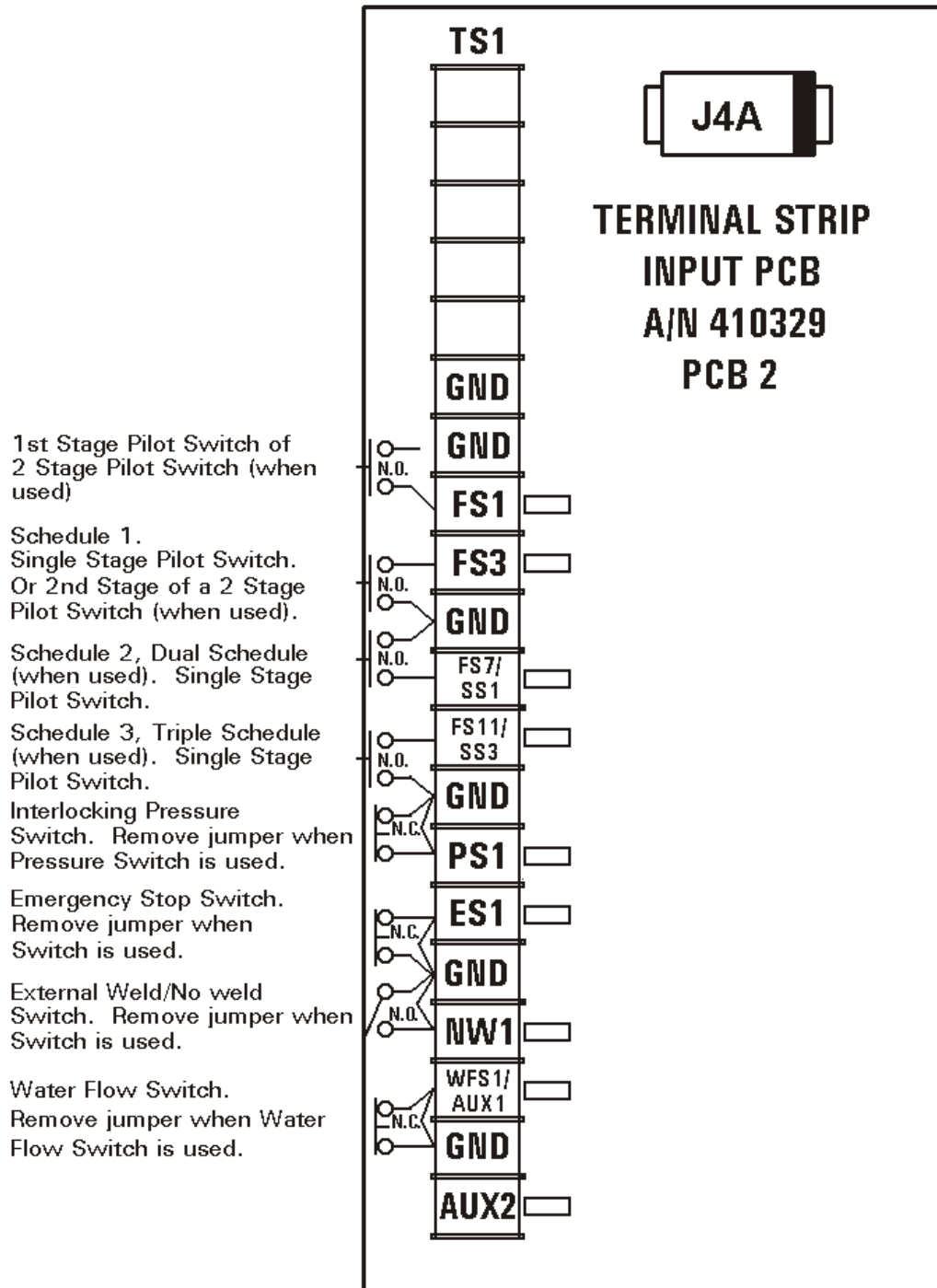


**Figure 4.2** Warning, Danger and Caution Labels

## 4.3 TERMINAL STRIP DIAGRAMS AND CONNECTIONS

### 4.3.1 TERMINAL STRIP INPUT TS1 ON PCB2 A/N 410329

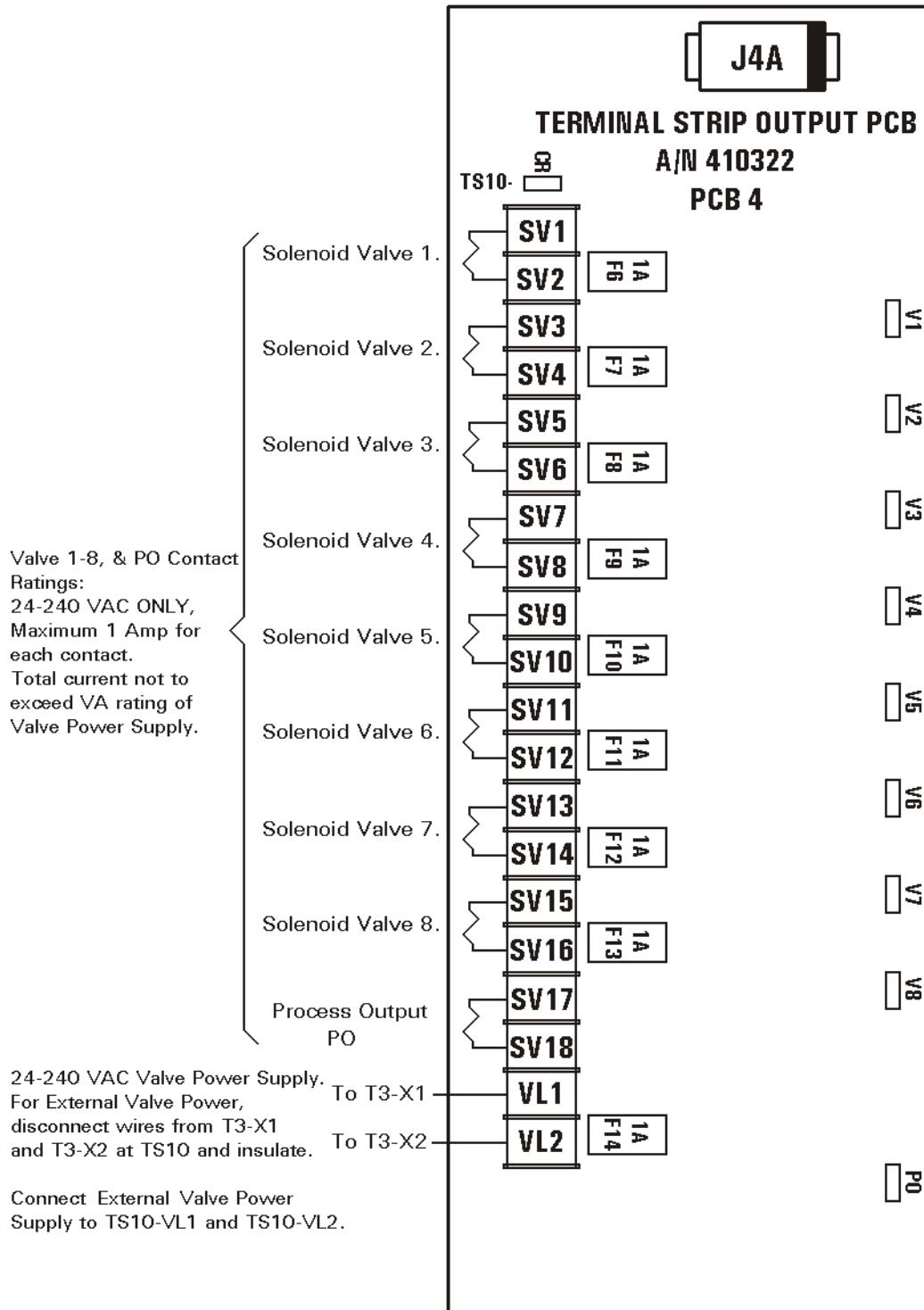
See customer WIRING DIAGRAM A/N 421214, all Cabinets, for more details.



**Figure 4.3.1** Terminal Strip Input Board

### 4.3.2 TERMINAL STRIP OUTPUT TS10 ON PCB4 A/N 410322

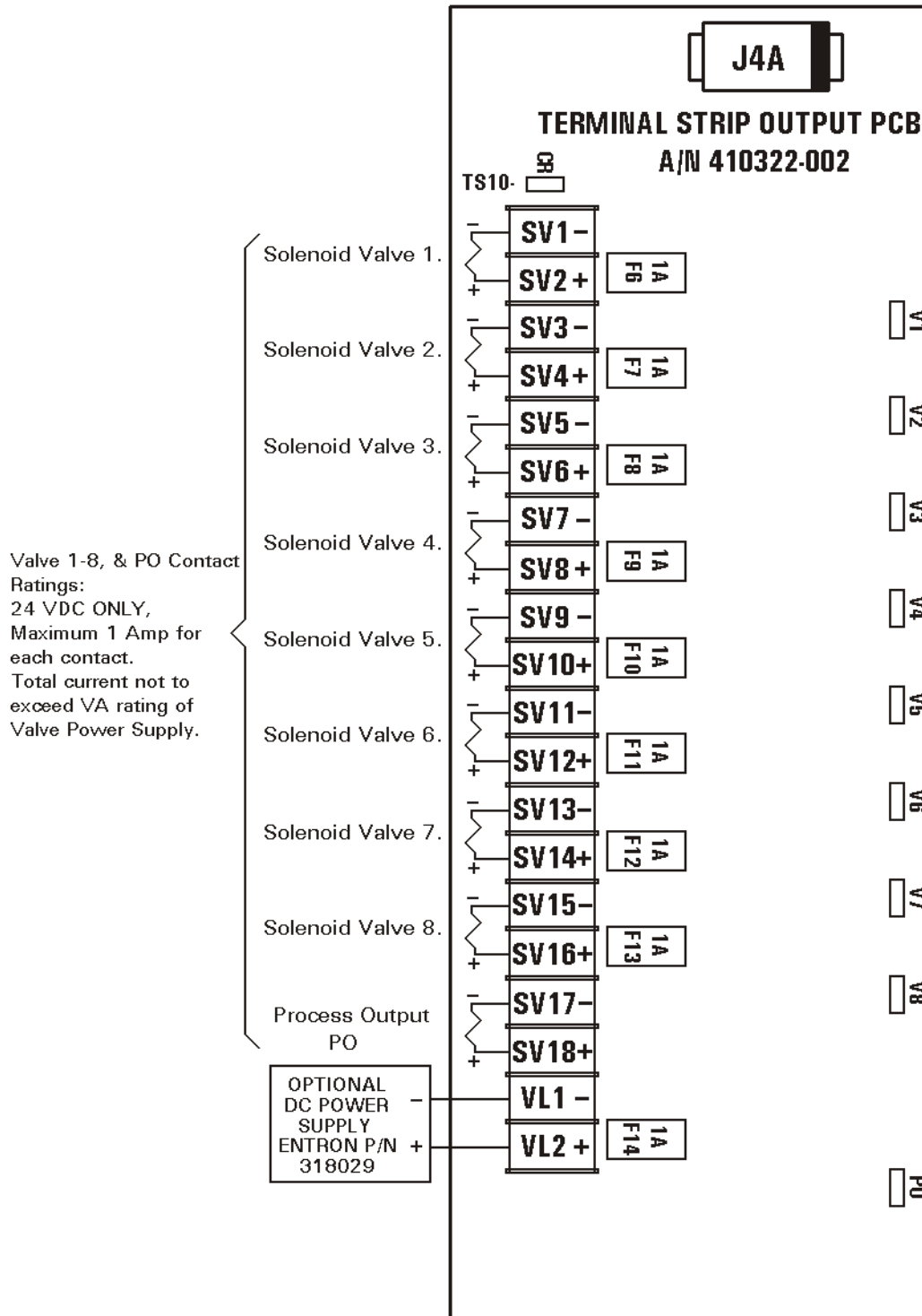
See customer WIRING DIAGRAM A/N 421214, all Cabinets, for more details.



**Figure 4.3.2a** Terminal Strip Output Board for 24-240 VAC

**NOTE:** An Optional 9-16 Valve Expansion Board A/N 410322-001 can be used for additional 8 valve outputs. See Application Note 700146 for more information.

Whenever DC Valves are used, standard Terminal Strip AC Output board must be replaced with an A/N 410322-002 Terminal Strip DC Output Board.



**Figure 4.3.2b** Terminal Strip Output Board for 24 VDC

**NOTE:** An Optional 9-16 Valve Expansion Board A/N 410322-003 can be used for additional 8 valve **24Vdc** outputs.



### 4.3.3 CUSTOMER TERMINAL STRIP CONNECTIONS

See the diagrams on Figure 4.3.1, Figure 4.3.2a and 4.3.2b.

TS1	<i>Terminal Strip Customer Connections Description</i>
TS1-GND	Used as the <b>Common Connection Point</b> for all of the other terminal strip input connections. There are six GND terminals provided on TS1.
TS1-FS1	Used to connect one side of the <b>First Stage of a Two Stage Pilot Switch</b> . Use a single pole, normally open, momentary type switch. Connect the First Stage of a Two Stage pilot Switch between TS1-FS1 and TS1-GND terminals.
<b>CAUTION</b> A JUMPER IS NOT REQUIRED ON TS1-FS1 TO TS1-GND WHEN A TWO STAGE FOOT SWITCH IS NOT USED. <b>DO NOT CONNECT GND TO EARTH GROUND.</b>	
TS1-FS3	Used to connect <b>one side of a Single Stage Pilot</b> . Connect a Single Stage Pilot between TS1-FS3 and TS1-GND terminals. Use a single pole, normally open, momentary type switch.
-or-	
	Used to connect <b>one side of a Two Stage Pilot</b> . Connect the Second Stage of a two Stage pilot between TS1-FS3 and TS1-GND terminals. Use a single pole, normally open, momentary type switch. When initiated via TS-FS3 the weld control will begin execution at the schedule actively shown in the Schedule Display.
-or-	
	Used to connect <b>one side of a Single Stage Pilot</b> for Dual Schedule operation. Connect a Single Stage Pilot between TS1-FS7 and TS1-GND terminals. Use a single pole, normally open, momentary type switch.
TS1-FS7	When initiated via TS1-FS7/SS1 the weld control will begin execution at SCHEDULE 20.
-or-	
	Used to connect <b>one side of a Two Stage Pilot</b> . Connect the Second Stage of a two Stage pilot between TS1-FS7 and TS1-GND terminals. Use a single pole, normally open, momentary type switch.
-or-	
	Terminal TS1-FS7/SS1 along with TS1-FS11/SS3 can also function as continued <b>inputs to select schedules externally</b> when Extended Function [55] = [01]. To connect for EXTERNAL SCHEDULE SELECT, Use two single pole normally open switches, one connected between TS-FS7/SS1 and TS1-FS3, the other between TS1-FS11/SS3 and TS1-FS3. As shown by the sketch in section 5.4.3, these switches can now be <b>used as pointers to one of four schedules</b> . TS1-FS3 is then used to initiate the schedule pointed to. See EXTERNAL SCHEDULE SELECT table in section 5.4.3.
-or-	
	Terminal TS1-FS7/SS1 along with TS1-FS11/SS3 can also function <b>as inputs for ANTI-TIE DOWN Initiations</b> when Extended Function [55] = [02]. To configure TS1-FS7/SS1 and TS1-FS11/SS3 as inputs for ANTI-TIE-DOWN. Use two single pole normally open switches, one connected between TS1-FS7/SS1 and TS-GND, the other between TS1-FS11/SS3 and TS1-GND. See section 5.4.3.

**TS1*****Terminal Strip Customer Connections Description***

- TS1-FS11    When initiated via TS1-FS11/SS3 the weld control will begin execution at SCHEDULE 40.
- or-
- Used to connect **one side a third Single Stage Pilot**. For initiations of a third of three pre-assigned schedules. Connect a single stage pilot between TS1-FS11 and TS1-GND terminals. Use a single pole, normally open, momentary type switch.
- or-
- Used to connect **one side of a Two Stage Pilot**. Connect the Second Stage of a two Stage pilot between TS1-FS11 and TS1-GND terminals. Use a single pole, normally open, momentary type switch. When initiated via TS1-FS11/SS3 the weld control will begin execution at SCHEDULE 40.
- or-
- Terminal TS1-FS11/SS3 along with TS1-FS7/SS1 can also function as **inputs to select schedules externally** when Extended Function [55] = [01]. To configure for EXTERNAL SCHEDULE SELECT, Use two single pole normally open switches, one connected between TS-FS11/SS3 and TS-GND, the other between TS1-FS7/SS1 and TS1-GND, as shown in the section 5.4.3. These switches can now be **used as pointers to one of four schedules**. TS1-FS3 is then used to initiate the schedule pointed to. See section 5.4.3 for more information.
- or-
- Terminal TS1-FS11/SS3 along with TS1-FS7/SS1 can also function as **inputs for ANTI-TIE DOWN Initiations** when Extended Function [55] = [02]. To configure TS1-FS11/SS3 and TS1-FS7/SS1 as inputs for ANTI-TIE-DOWN use two single pole normally open switches, one connected between TS1-FS11/SS3 and TS-GND, the other between TS1-FS7/SS1 and TS1-GND. See section 5.4.3.
- TS1-PS1    Used to connect **one side of a PRESSURE Switch**. When used, remove jumper between TS1-PS1 and TS1-GND terminals and install normally open Pressure Switch contacts.
- TS1-ES1    Used to connect **one side of an EMERGENCY STOP Switch**. When used, remove jumper between TS1-ES1 and TS1-GND terminals and install a single pole, normally closed Emergency Stop Switch. It is possible to install several Emergency Stop Switches in series. Activation of any one switch will put the control into the Emergency Stop condition.
- TS1-NW1    Used to connect **one side of an External WELD/NO WELD Switch**. When used, remove jumper between TS1-NW1 and TS1-GND terminals and install a single pole, normally open switch. The switch must be closed to weld.
- TS1-WFS1 / AUX1    Used to connect **one side of a WATER FLOW Switch**. When used, remove jumper and install a normally closed Water Flow switch between TS1-GND and TS1/WFS1/AUX1 terminals. This terminal may also be used for an AUXILIARY function in Retraction modes or for Back-Step mode.
- TS1-AUX2    Currently not used. Reserved for future expansion.

## CAUTION

When external valve power is used (24-240 VAC), on Terminal Strip Output PCB Board A/N 410322 (or A/N 410322-001), the internal valve transformer **must** be disconnected at TS10-VL1 and TS10-VL2.

Properly **insulate** the wires from X1 and X2 of the valve transformer.

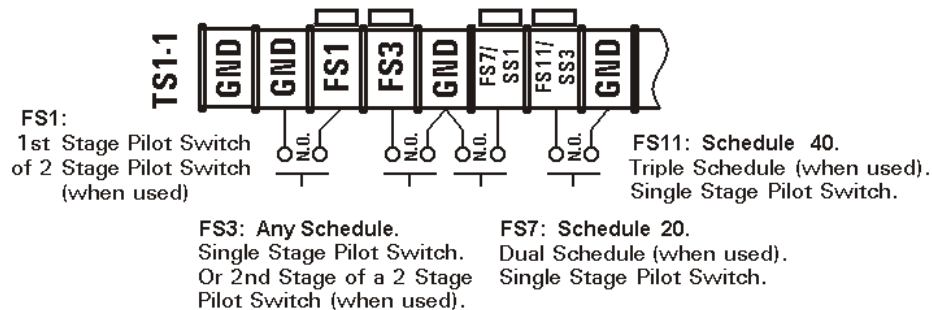
## 4.4 INITIATION

The EN1000/1001 Series of controls are equipped with four weld initiation inputs FS1, FS3, FS7 and FS11, as shown on Figure 4.4.1 (see also section 5.4.3), and provide two basic weld initiations:

- single stage pilot, and
- two stage pilot initiation.

For more information about routing and wiring of initiation wires see Section 4.6.

**NOTE:** This control can be programmed to BEAT OPERATION by programming [b.E.] parameter in Extended Functions. See section 5.4.8. Several modes are available.



**Figure 4.4.1** *Initiation inputs on the Terminal Strip TS1*

### 4.4.1 INITIATION - SINGLE STAGE PILOT

**SINGLE STAGE INITIATION** - Connect the pilot switch between TS1-FS3 and TS1-GND. Once the control is initiated, the switch need not remain closed. The initiation circuit is automatically latched until the control has completed the sequence. In the repeat mode the control will continue to sequence as long as the initiation remains closed. No connection is made to TS1-FS1. See section 4.3 TERMINAL STRIP DIAGRAMS.

### 4.4.2 INITIATION - TWO STAGE PILOT

**TWO STAGE INITIATION** - Connect the first stage between TS1-FS1 and TS1-GND; then connect the second stage between TS1-FS3 and TS1-GND. The **FIRST STAGE (FS1)** activates the solenoid valves programmed in the selected schedule, and will not initiate a sequence. The **SECOND STAGE (FS3, FS7 or FS11)** INITIATES the sequence in the schedule associated with the chosen foot switch (FS) connection. See also section 5.4.3. It is possible to initiate three separate schedules in two stage configuration.

Once the control is initiated via FS3, FS7 or FS11, first stage FS1 does not need to remain closed. The initiation circuit is automatically latched to prevent re-initiation until after the control has completed its sequence. **In the repeat mode the control will continue to sequence as long as either stage remains closed.**

## 4.5 OTHER TERMINAL STRIP INPUTS

**PRESSURE SWITCH** - This feature is used to make the control **wait** if the required pressure has not been reached while in the SQUEEZE interval as follows:

After initiation, the control advances through SQUEEZE. If the **pressure switch is not active (pressure not sufficient)** the control **waits**, and the SQUEEZE LED flashes at the end of squeeze. **When** the pressure switch closes (**pressure is sufficient**), the flashing stops and the control begins to WELD and **completes** the sequence.

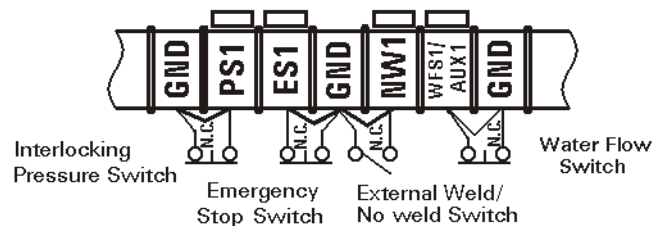
If the Pressure Switch interrupts the sequence for an extended period, the display will flash the ERROR Code [15]. **This error will not terminate the sequence. Once the pressure switch closes, the sequence will continue on to WELD and complete the sequence.** See section 4.3.3 CUSTOMER TERMINAL STRIP CONNECTIONS.

**NOTE:** If a pressure switch is not used, place a jumper (factory installed) between TS1-PS1 and TS1-GND. **Pressure Switch is not furnished with the control.**

EN1000/EN1001 Series Controls with firmware A/N **619044-002A** revision or later will have the following Pressure Switch Function Revised.

As of this Revision the Pressure Switch will be ignored if Weld Time is set to [00]. This allows sequences that use features such as Clamp & Weld to only have the Pressure Switch checked for the Weld Sequence.

Before this Revision the Pressure Switch was checked after squeeze in all schedules, including chained schedules.



**Figure 4.5.1** Other inputs on the Terminal Strip TS1

**EMERGENCY STOP** - When the Emergency Stop switch is active (open), the control **stops any and all processes (all valves and firing pulses.)** While in the Emergency Stop condition, the control will flash [ E.5. ] on the DATA and SCHEDULE Displays until the condition has been cleared. If the execution of a schedule was interrupted by means of the Emergency Stop Switch, the control will not re-initiate automatically (after the emergency condition is removed). Upon release of the switch, it must be re-initiated by closing the pilot switch.

**NOTE:** If the **Emergency Stop Switch** is not used, place a jumper between **TS1-ES1** and **TS1-GND**, factory installed. Emergency Stop Switch is **not supplied** with the control.

**WELD/NO WELD SWITCH and LED INDICATORS** - When the control is in NO WELD, the NO WELD LED is illuminated. This allows the operator to initiate a weld sequence without passing current through the welding transformer. When the WELD LED is illuminated, the control switching circuitry will pass current through to the welding transformer during the programmed weld time *only* if WELD SWITCH is closed. If this switch is open, the Control will be in the NO-WELD mode even if WELD LED is illuminated.

**NOTE:** If a weld/no weld switch is not used, place a jumper (factory installed) between TS1-NW1 and TS1-GND. **Weld/No Weld Switch is not supplied with the control.**

**WATER FLOW SWITCH or AUXILIARY SWITCH** - This feature is used to inhibit welding if Water is **not** turned ON.

If the this input is active (open) the control cannot be initiated until the Water Flow switch is not closed. Also, if this input becomes active (OPEN) during a weld, the firing pulses to the switching circuitry will continue until the end of WELD Time; HOLD and OFF will execute normally but a new sequence cannot be initiated until the input Switch is closed. In either of the above cases, the DATA Display will show ERROR Code **Err. = 01** until the Water Flow Switch recovers its normally closed state, then the control will return to normal operation. See Section 11.2 TROUBLE SHOOTING.

**NOTE:** If the Water Flow Switch is not used, place a jumper between TS1-WFS1/AUX1 and TS1-GND terminals.

**TEMPERATURE LIMIT SWITCH - TS8 terminals on SCR's firing board** - This feature is used to inhibit welding if the TEMPERATURE of the SCR heatsink is above the rated operating temperature.

If the this input is active (open) the control cannot be initiated until the temperature limit switch cools (resets). Also, if this input becomes active (OPEN) during a weld, the firing pulses to the switching circuitry will continue until the end of WELD Time; HOLD and OFF will execute normally but a new sequence cannot be initiated until the Temperature Limit Switch cools and resets (closes). In either of the above cases, the DATA Display will show ERROR Code **Err. = 01** until the Temperature Limit Switch recovers its normally closed state; then the control will return to normal operation. See Section 11.2 TROUBLE SHOOTING.

**NOTE:** If the Temperature Limit Switch is not used, place a jumper between TS8 terminals on all SCR's firing boards.

## 4.6 NON-VOLATILE MEMORY ERROR

All ENTRON microprocessor based controls make extensive use of non-volatile memory devices for parameter data storage. Although safety features (control relays and opto-isolation) are in place to insure high voltage spikes do not appear on low voltage circuits, non volatile memory devices can sometimes be affected by improper hook up, electrical disturbances generated in other equipment operating nearby, or in the welding machine itself.

When an ENTRON (microprocessor series) control is powered up, or returns from an emergency stop condition, it executes a diagnostic test that reads all memory locations within the schedule storage areas. If invalid data is stored in memory, the control will display a flashing [32] in the data display window, and [E.r.] in the schedule window alternating with the number of the schedule where the invalid data (error) was found. If the invalid data was found in the extended function's memory area, [EF] alternates with [E.r.].

The Error 32 indication does not mean there has been damage to the welding control. It simply means something has caused invalid data to be stored in one or more memory locations. The control will not sequence until this error has been corrected.

To recover from this condition:

1. Press the SELECT push-button to stop the flashing.
2. Place the control in the PROGRAM MODE.

At this point, the operator can use SELECT to find the Function containing the invalid data.

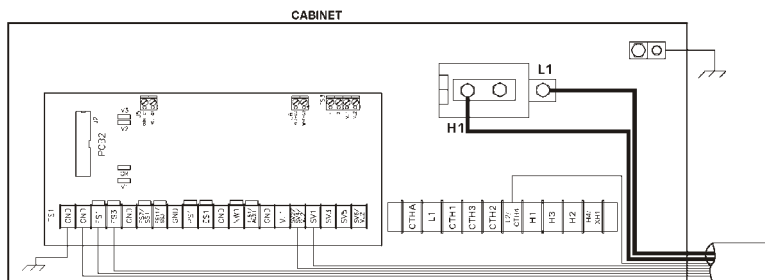
3. Use the DATA push-buttons to correct the DATA.
4. Press ENTER.
5. Return the control to the OPERATE MODE.

If more than one location has been affected, it may be necessary to use the CLEAR ALL command in the EXTENDED FUNCTIONS to erase all the memory locations and restore the default settings (Factory Settings).

### **Reoccurring Error 32** (Error Code 14 Flashing in Previous Revisions)

The effects of electrical disturbances can be minimized or prevented by observing the following precautions when installing the welding control:

1. Make sure the cabinet is properly grounded to the power distribution system, nearby water pipe or other effective building ground with a wire adequate for its application.
2. All wires connected to the pilot input terminals on the TS1 terminal strip (FS1, FS3, FS7, FS11, PS1, ES1, NW1, WFS1, and their adjacent GND terminals) should be separated as much as possible from other wires connecting to solenoid valves, welding transformers, and the AC line. These pilot input wires should never be run through the same conduit with the solenoid, welding transformer and AC line wires. Connection of any GND terminal to earth ground might cause Error [32].



**WRONG** example for wiring and routing of low and high voltages conduit for typical EN1000 series Controls is shown on Figure 4.6.1

**Figure 4.6.1** Example of Low and High voltages conduits



## 4.7 EN1000/EN1001 ISOLATION CIRCUITRY DESCRIPTION

The EN1000 Series of controls are microprocessor based resistance welding controls that incorporate circuitry designed to prevent any output from the control due to spurious or unexpected or false conditions or failure of circuit components. The intent of this application note is to explain how the circuitry accomplishes this isolation.

The main isolation is provided by electro mechanical control relay contacts that are in series with the solenoid valve voltage supply and the CONTACTOR firing circuitry. In a non initiated state, the relay contacts are open and no output from these circuits are possible. When the control is initiated by the physical closure of a normally open set of external contacts (commonly a foot switch) across the initiation circuit, the relays are energized and their contacts close and complete the circuits to the solenoid valve and the contactor. The outputs are not actually energized, however, until the microprocessor reaches the point in the sequence at which the valve or contactor outputs are to be activated.

There is no way to guarantee that any control circuit will be immune to component failure. It is always necessary to take personal safety precautions when operating any machinery.

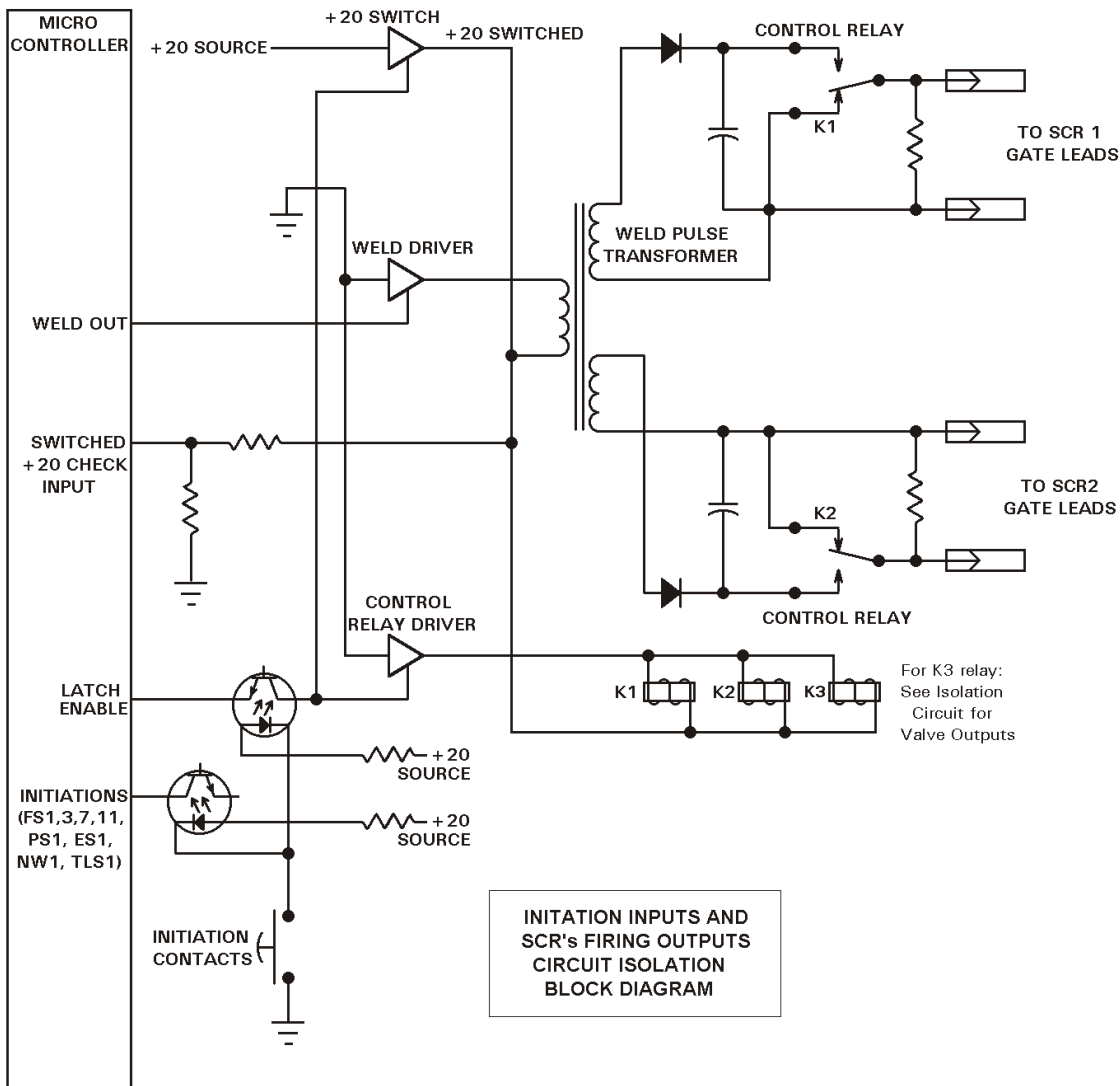


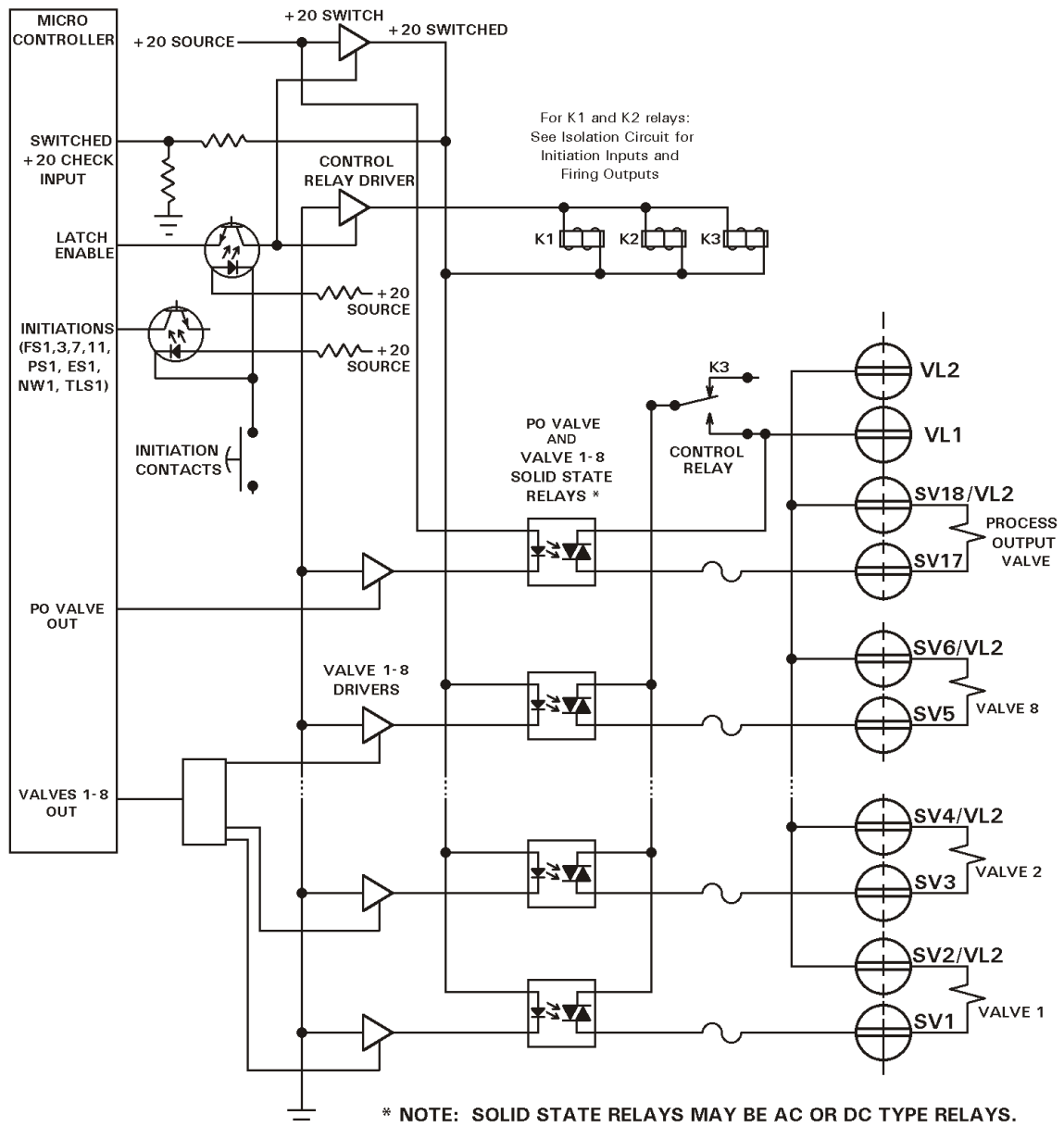
Figure 4.7.1 Isolation circuit Block Diagram



Through a "process output" system, the EN1000 Series of controls can be programmed so that if the 20 volt energizing voltage for the isolation relays appears in the absence of an initiation, or if the SCR contactor conducts current at any time other than when programmed, an output voltage will appear at the PO valve terminals. This voltage can be used to sound an alarm or operate a shunt trip breaker to remove line voltage from the machine and the control.

**NOTE:** PO Valve SV17-SV18 will not be isolated.

In addition to the relay contacts mentioned above, there are other levels of isolation. The initiation signals first pass through a circuit comprised of optoisolators before being passed to the input circuitry of the microprocessor. The valve outputs are further isolated by the use of optically coupled triac (solid state) outputs and the weld pulses are isolated by a pulse transformer.



**Figure 4.7.2** Isolation circuit Block Diagram for Valve Outputs

## 5. INTRODUCTION TO DATA PROGRAMMING

The EN1000 or EN1001 Cascade Multivalve control is capable of storing and accessing up to 100 unique welding Schedules. This makes the EN1000 or EN1001 particularly suitable for complex welding operations, as well as automated machinery. Programming allows the operator to enter or change parameters of weld SCHEDULES and the subsequent storing of those parameters in non-volatile memory.

Basically, programming only requires **selecting** the FUNCTION to be programmed (or modified), **changing** the data (with DATA display/push-buttons) applicable to that function, and then **entering** the desired parameters into memory.

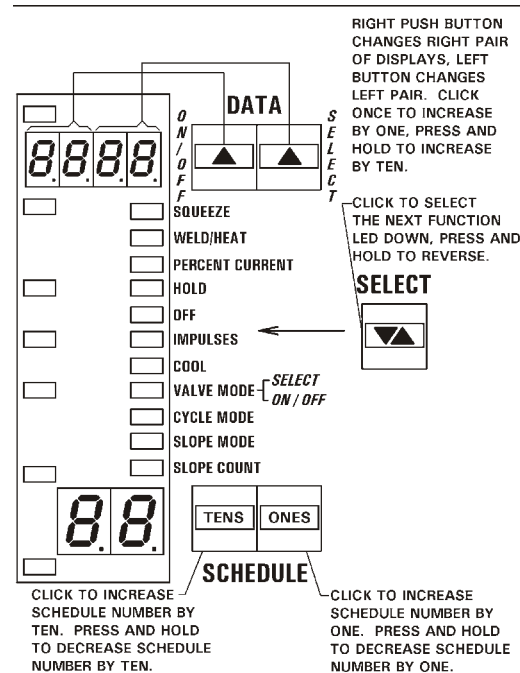


Figure 5.1 Four digit DATA display

### 5.1 GENERAL PROGRAMMING

1. **Press and release the PROGRAM/OPERATE switch.** The PROGRAM LED will light up and the OPERATE LED will turn off. Only in the PROGRAM MODE, the control allows changes to existing data or entering new data. If an optional PROGRAM LOCKOUT Key Switch is installed, see PROGRAM/ LOCKOUT following step 6.
2. **Select the SCHEDULE to be entered or modified by using the SCHEDULE push-buttons** until the desired schedule number appears on the schedule display. **The left push-button increments the display by ten, and the right push-button increments the display by one.** When the maximum number is reached for either digit, that digit resets to zero.
3. **Press the SELECT push-button to reach the required function.** Pressing and holding the select button momentarily will move to the previous parameter. The FUNCTION INDICATOR LEDs show which function may be entered or modified, and the DATA DISPLAY shows the data stored in that function. **If the SELECT push-button is pressed again, the function indicator will advance to the next function.**

**NOTE:** When the function indicator LED is advanced **one position past the SLOPE COUNT function**, all function indicator LEDs will be off and the DATA DISPLAY will show [EF]; This indicates that the control is in the EXTENDED FUNCTION mode and the extended functions can now be altered or viewed. See section 5.4 EXTENDED FUNCTIONS.

4. Use the DATA push-buttons to change data. **The left button increments the data by ten, and the right button increments the data by one.** When either digit reaches the maximum, that digit resets to zero. See section 5.3 PROGRAMMING PARAMETERS.

5. PRESS the ENTER push-button to store the data from the DATA DISPLAY into non-volatile memory. As the enter key is pressed, the data display will blink and then remain steady.

Repeat the steps described above as required. Any or all Functions may be programmed depending on the final welding schedule or sequence required.

**NOTE: Remember to press the ENTER push-button to complete a programming step.** If the control is placed back in the operate mode, or if a different function is selected before pressing the ENTER key, the DATA shown in the display will be lost. The previous data will remain stored in memory.

6. When all the required FUNCTIONS for all required SCHEDULES have been programmed, put the control in the OPERATE mode by pressing and releasing the PROGRAM/OPERATE push-button switch, as in STEP 1, so that the OPERATE LED turns on and the PROGRAM LED turns off.

## 5.2 PROGRAM LOCKOUT OPTIONS

### 5.2.1 PROGRAM LOCKOUT KEY OPTION

A PROGRAM LOCKOUT (25) key switch can be ordered as a factory installed option. It may also be added later by the customer, if desired. To install the key switch, remove the hole plug from the lower left corner of the front panel and mount the switch using the nut provided. Plug the wires from the switch onto the mating two prong connector on the back of the control circuit board.

Mounting the key switch will be easier if the front panel control circuit board assembly is removed from the enclosure. Remove the four mounting screws from the front panel and lift it off of the enclosure.

**To put the control in the PROGRAM mode using the PROGRAM LOCKOUT Switch:**  
Rotate the key 45 degrees clockwise and hold; While holding the key in this position, press and release the PROGRAM/OPERATE push-button, and then release the key. The OPERATE LED will now turn off and the PROGRAM LED will turn on, indicating programmability of all functions.

**To put the control in the OPERATE mode:**

Press the PROGRAM/OPERATE push-button again. The control will return to the OPERATE Mode without the necessity of rotating the Key.

### 5.2.2 USING PROGRAM LOCKOUT KEY FOR ERROR CLEARING

Most errors except initiation, heatsink over temperature, and pressure errors (errors from **01** to **15**, and **36**), may be cleared by pressing any push-button on the front panel. However, if a program lockout switch is installed in the control, a key may be necessary for error clearing voltage monitoring, current monitoring and several other non hardware related error codes (all errors from **17** to **35**, **37**, **H. 1.** and **L.o.**) require that a key must be used to clear the error condition and reset the control.

### 5.3 SEQUENCE (SCHEDULE) PARAMETERS PROGRAMMING

Beside standard schedule parameters, there are several extended parameters. The associated extended schedule parameters are accessible by first using SELECT to choose the main function such as SQUEEZE, and then clicking either SCHEDULE push-button to access a schedule function such as [*P.r.*] or [*P.t.*].

PARAMETER	EXTENDED	Description	MIN	MAX
SQUEEZE		Squeeze time in 50/60Hz cycles	00	99
*	<i>P.r.</i> <i>P.t.</i> [PSI]	Pressure Mode: <i>P.C.</i> = 01 or 02	00	99
	<i>F.r.</i> <i>F.t.</i> [Lb]	Force Mode: <i>P.C.</i> = 03 or 04	0000	9999
	<i>A.r.</i> <i>A.t.</i> [mA]	mA Mode: <i>P.C.</i> = 05 or 06	04.00	20.00
WELD/HEAT			00	99
	<i>0.0, 0.1, ..., 0.9</i>	Stepper 0, Schedule <i>00</i> to <i>09</i>		
	<i>1.0, 1.1, ..., 1.9</i>	Stepper 1, Schedule <i>10</i> to <i>19</i>		
	<i>2.0, 2.1, ..., 2.9</i>	Stepper 2, Schedule <i>20</i> to <i>29</i>	0000	9999
	<i>3.0, 3.1, ..., 3.9</i>	Stepper 3, Schedule <i>30</i> to <i>39</i>		
	...			
	<i>9.0, 9.1, ..., 9.9</i>	Stepper 9, Schedule <i>90</i> to <i>99</i>		
	<i>L.S.</i>	Last Step, for Stepper: <i>S.t.</i> = 01	00	99
	<i>L.C.</i>	Last Count, for Stepper: <i>S.t.</i> = 01	0000	9999
CURRENT		Percent Current phase shift, [%] mode	00	99
**	[%] mode <b>EN1001 only</b>	Current in [%] or [kA] : <i>L.r.</i> > 00	00.00	99.99
	or <i>L.o.</i>	Low current limit window	00.00	99.99
	[kA] mode <i>H. i.</i>	High current limit window	00.00	99.99
HOLD			00	99
OFF			00	99
IMPULSES			01	99
COOL			00	99
VALVE MODE			00	FF hex
***	<b>410322-001</b> <i>E.o.</i>	Extended Valve Output	00	FF hex
CYCLE MODE			00	05
SLOPE MODE			00	02
SLOPE COUNT			00	99
CONTACTOR			00	FF hex

\* - Available only if IPSC option is present. \*\* - Available only in EN1001 Controls. \*\*\* - Available only if Extended Valve option is present. For more information about IPSC option, see manual 700178. For more information about programming and using **steppers**, see Section 7. More information about Constant Current on EN1001 in Section 8.

Times for WELD, COOL, SLOPE COUNT and all other timed sequence parameters (SQUEEZE, HOLD, OFF) are based on 60 Hz or 50 Hz frequency.

### 5.3.1 PROGRAMMING VALVES AND CONTACTORS

The EN1000 Cascade Multivalve Control has been designed with versatility in mind. It features eight valve outputs on the Standard Output Board. A ninth output is provided for use by the control's Process Outputs. In addition, the control can activate one of up to eight contactors as it is shipped from the factory. Please note that the control will accept programming of non-existent contactors. For example, a three Cascade control can be programmed to fire contactor 4. This will not affect the control but care must be taken when programming only supplied contactors.

#### PROGRAMMING THE VALVES

The EN1000 Cascade Multivalve is capable of simultaneously activating up to eight valves in any pattern for each programmed schedule.

##### Using VS/ VO [ VS = Valve Select, VO = Valve On/Off ]:

The DATA push-buttons perform dual functions. Please note that there are two steps necessary to program valves **before the ENTER key is pressed**. While selecting valves in a schedule, the DATA push-button labeled "**VS**" is used to select a VALVE. The DATA push-button labeled "**VO**" is used for turning the VALVE indicator LEDs ON or OFF. Active valves for a Schedule are indicated by the LEDs that are on.

While in the desired Schedule and in the PROGRAM MODE:

1. Press SELECT and move the Indicator LED to VALVE MODE.
2. Press VS to select a valve. Corresponding segment of **upper** part of 7-segment digits on DATA displays and the corresponding VALVE LEDS will turn ON.
3. Press and release **VO, the selected valve will turn on**. Repeat steps 2 and 3 above until all the needed valve LEDs are lit on the VALVE display.
4. Press ENTER in order to store the pattern being displayed.

#### PROGRAMMING THE CONTACTORS

The EN1000 Cascade Multivalve is able to activate one contactor for each programmed schedule. In order to **compose a cascade function** it is necessary to **chain various schedules together**. This allows the operator more flexibility in the firing of individual contactors, since **each contactor can be fired for different lengths of time and with varying amounts of heat**.

##### Using CS [CS = Contactor Select ]:

The DATA button labeled "**CS**", is used to select a CONTACTOR. This step is necessary to program a contactor before pressing the ENTER key. While in the process of selecting a CONTACTOR, since only one contactor can be selected for one schedule, this step automatically turns the contactor LED on (except in Simultaneous Firing Mode).

While in the desired Schedule and in the PROGRAM MODE:

1. Press SELECT and move the Indicator LED to CONTACTOR SELECT
2. Use CS to select one of eight contactors. Corresponding segment of **lower** part of the 7-segment digits on DATA displays, and the corresponding CONTACTOR LED will turn ON .
3. Press ENTER in order to store the contactor being displayed.

### 5.3.2 USING PROGRAMMING SHORTCUTS

#### TO QUICK COPY A SCHEDULE UP TO THE NEXT SCHEDULE

1. Put the control in the PROGRAM Mode.
2. Press and hold ENTER.
3. Click the SCHEDULE “ONES” button.

The displayed schedule is copied to the next higher schedule. The new schedule is displayed.

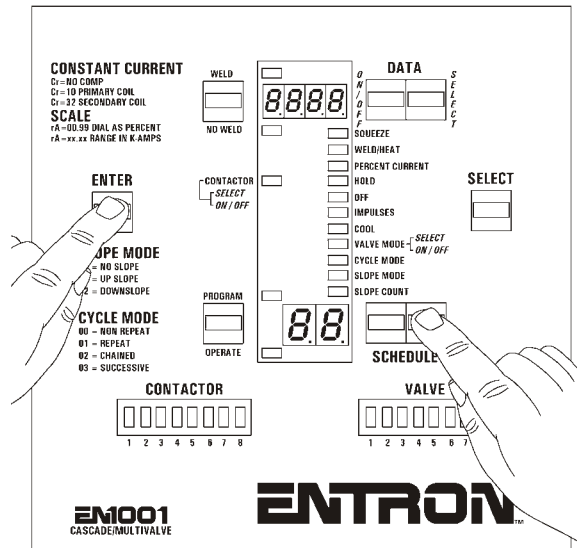


Figure 5.3.1 Copy Schedule Up by 1

#### TO QUICK COPY A SCHEDULE UP TEN SCHEDULES

1. Put the control in the PROGRAM mode.
2. Press and hold ENTER.
3. Click the SCHEDULE “TENS” button.

The displayed schedule is copied to that schedule number plus ten. The new schedule is displayed.

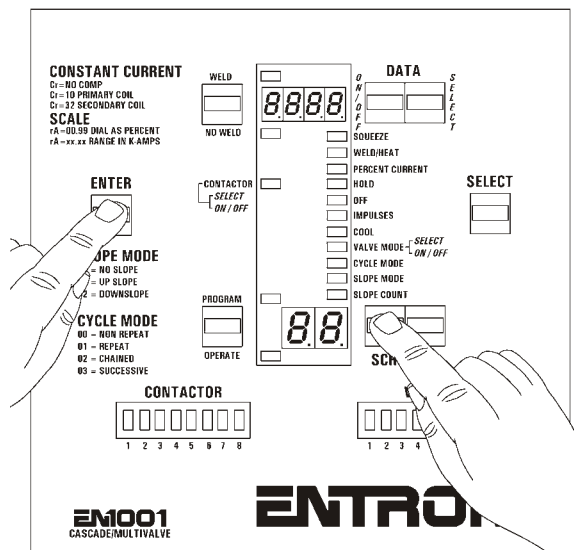


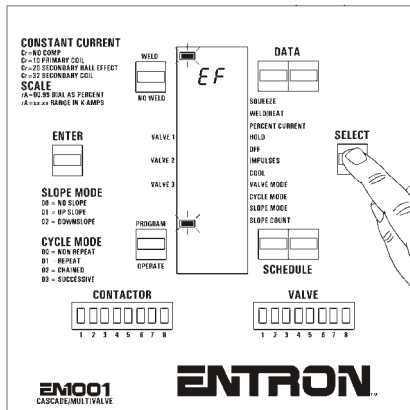
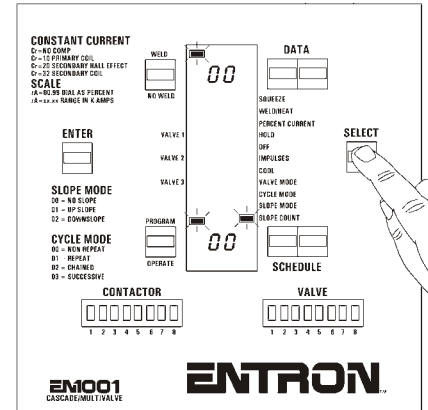
Figure 5.3.2 Copy Schedule Up by 10

## 5.4 EXTENDED FUNCTIONS

The EN1000 EXTENDED FUNCTIONS allow the operator to change normal operation modes and add various operating functions that are useful for special applications of the control.

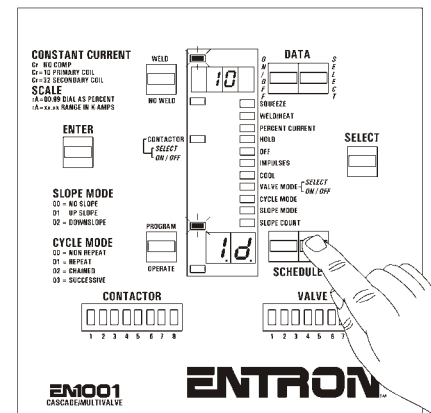
The Extended Functions are used instead of Jumper or Dip-switch settings. They are accessible from the front panel. To access the Extended Functions, simply click the SELECT push-button until the indicator LED reaches Slope Count, then click once more. At this point the top display will show [EF]. By clicking the SCHEDULE Push-Buttons, the extended functions are visible in the bottom display. For most features, such as Chaining schedules, or Successive initiations, it is not necessary to enable functions. For some others, it is necessary to just enable a front panel accessible Extended Function such as the Stepper, [5.4]. For others, it is necessary to add optional hardware to the base control, such as the Integrated Pressure Sense Control System or Constant Current operation.

To change settings of the EXTENDED FUNCTIONS, use SELECT to step ONCE past SLOPE COUNT.



At this point, all function indicator LEDs are off and the DATA display shows [EF]. This indicates that the control is in the EXTENDED FUNCTION mode, and these functions can be altered or viewed.

To view the EXTENDED FUNCTIONS, press the SCHEDULE push-buttons and step in either direction through the available EXTENDED FUNCTIONS. When a desired parameter is shown by the SCHEDULE display, the DATA display will show the current value of that selection.



To exit the EXTENDED FUNCTIONS mode, press SELECT to advance the function indicator one more time.

The EXTENDED Function Parameters are:

*l.d., C.S., S.S., C.C., C.A., b.S., P.O., b.E., F.c., C.P., F.O., S.d., b.L., C.r., r.A., C.O., S.t.,  
P.C., b.d., S.l., P.n.*

*Available only if IPSC hardware is present.*

*Only for Constant Current.*

The table below lists the available EXTENDED FUNCTIONS; They will be described in the sections to follow:

<u>DESIGNATION</u>	<u>DESCRIPTION</u>	<u>SECTION</u>
<i>l.d.</i>	Identification Number	5.4.1
<i>C.S.</i>	Simultaneous Contactor Firing	5.4.2
<i>S.S.</i>	Schedule Select	5.4.3
<i>C.C.</i>	Automatic Voltage Compensation	5.4.4
<i>C.A.</i>	Clear All	5.4.5
<i>b.S.</i>	Back Step	5.4.6
<i>P.O.</i>	Process Output	5.4.7
<i>b.E.</i>	Initiation Modes/Beat Operation	5.4.8
<i>B.7.</i>	87 degree Delay	5.4.9
<i>P.P.</i>	Manual Power Factor	5.4.10
<i>P.F.</i>	Power Factor Measuring	5.4.11
<i>S.d.</i>	Squeeze Delay	5.4.12
<i>b.L.</i>	Block Delay (if [ <i>P.O.</i> ]= <b>07</b> only)	5.4.13
<i>C.r.</i>	Constant Current mode (EN1001 only)	5.4.14
<i>r.A.</i>	Range or Ratio (EN1001 only)	5.4.15
<i>C.O.</i>	Current Offset	5.4.16
<i>S.t.</i>	Stepper	7.0
<i>P.C.</i>	Pressure Control mode	IPSC Manual
<i>b.d.</i>	Background pressure	IPSC Manual
<i>S.l.</i>	Input from the Pressure Sensor	IPSC Manual
<i>P.n.</i>	<b>PIN</b> for Software Lockout mode	5.4.17

### 5.4.1 IDENTIFICATION NUMBER - [*l.d.*]

The EN1000/EN1001 control may be equipped with RS485 option to communicate to a PC or any other device with RS485 interface. The device with RS485 interface is capable of communicating with up to 64 Controls on a common two-wire network. For this reason the control needs to be identified.



## 5.4.2 SIMULTANEOUS FIRING OF CONTACTORS - [C.5.]

The mode parameter, [C.5.], in the Extended Functions on the SCHEDULE display allows the control to be programmed with multiple contactors within the same schedule in the EN1000/EN1001 Cascade Multivalve Controls. This offers the advantage of increased productivity in plants where the higher line current demand is not a problem.

**NOTE:** This mode applies to Cascade Program PCB's A/N 410321 with firmware 619011-002 Orig. Rev. or later, or 619044-002B or later, and PCB's A/N 410363 with firmware 619044-002 Orig. Rev. or later.

Extended Function [C.5.] allows the control to be switched to Simultaneous Firing Mode. That is, program more than one contactor per schedule. The simultaneously fired contactors will use the percent current programmed in the indicated schedule. It is not possible to fire simultaneous contactors with different percent currents.

If the DATA display shows a value of 00 for the [C.5.] parameter, the control allows selection of only one contactor per schedule. If the DATA display shows 01, for the [C.5.] parameter, the control allows programming of multiple simultaneous contactors. The contactors may be programmed using the same procedure used for programming the valves. That is, select a valve/contactor needed by pressing VS (DATA ONES), and turn it on or off by pressing VO/CS (DATA TENS).

Switching from Single Contactor Mode to Simultaneous Contactor Mode requires use of the memory in a different way. Therefore, it is necessary to re-program the contactors.

**NOTE: RECORD AND SAVE ALL SCHEDULES PROGRAMMED IN THE CONTROL.**  
When switching to simultaneous mode or returning to single contactor mode, the user must re-program the contactors in all the schedules used.

To Enable the control to program Simultaneous Contactors:

1. Put the control in PROGRAM Mode.
2. Press SELECT and find [EF] in the DATA Display (the top display).
3. Press the SCHEDULE push buttons and find [C.5.] on the bottom display.
4. Dial 01 in the DATA Display and press ENTER.

To Program Multiple Contactors:

1. Program the control as normal, with the exception of the contactors.
2. Select the Schedule that requires more than one contactor to be fired simultaneously.
3. Select the [C.5.] (Contactor Select) parameter.
4. Select contactors :                      Press the CS/VS button by the DATA display to make the contactor LED's blink.
5. Form the contactor pattern:            Press the VO button by the DATA Display to turn the LED On.
6. Repeat steps 4 and 5 until the required contactors are selected, (LED's for selected contactors for this schedule will be lit). Press ENTER to store pattern in memory.

### WARNING

Using simultaneous contactor firing defeats the original cascade design purpose. Cascade controls are single phase controls used to distribute power to multiple loads at different times on a single phase line. Users must take responsibility for what is programmed in the control. Selecting an excessive number of contactors could cause excessive current draw. Primary wiring is sized for firing only **one** SCR Contactor at a time.

### 5.4.3 SCHEDULE SELECT [5.5]: INTERNAL, EXTERNAL, ANTI-TIEDOWN

The EN1000/EN1001 provides the user with four modes of Schedule SELECTION and/or INITIATION. An INTERNAL (panel-dialed), EXTERNAL (non-panel, FS7/FS11 select), an ANTI-TIE DOWN (panel-dialed, two-hands initiation), and an EXTERNAL binary select using S99 option. The default (factory settings) mode for this control is INTERNAL SCHEDULE SELECT.

To program the control for INTERNAL/EXTERNAL SCHEDULE selection or ANTI-TIE DOWN initiations:

1. Put the control in PROGRAM MODE.
2. Use SELECT to find [EF].
3. Use the SCHEDULE push-buttons to scroll through the extended functions and find schedule select parameter [5.5].
4. Enter a value for [5.5] of: [00], [01], [02], or [03] using the DATA push-buttons.

*Where:* [5.5] = [00] for INTERNAL SCHEDULE SELECT (default).

[5.5] = [01] for EXTERNAL SCHEDULE SELECT.

[5.5] = [02] for ANTI-TIEDOWN INITIATIONS.

[5.5] = [03] for S99 EXTERNAL SCHEDULE SELECT. See S99 manual 700115.

5. Press the ENTER push-button.

#### INTERNAL SCHEDULE SELECT [5.5] = [00] (default)

In this mode the initiation (TS1- FS3, TS1-FS7, AND TS1-FS11) inputs are dedicated as follows:

TS1-FS3 INITIATES ON ANY DISPLAYED SCHEDULE:

1. Select a schedule using the SCHEDULE push-buttons.
2. Program the selected schedule or a sequence.
3. **Use FS3 to initiate ANY schedule shown on the panel.**

TS1-FS7 AUTOMATICALLY SELECTS AND INITIATES ON 20:

1. Select schedule 10 using the SCHEDULE push-buttons.
2. Program SCHEDULE 20 (or a sequence starting at schedule 20).
3. **Use FS7 to initiate schedule 20 (or a sequence starting at schedule 20).**

**NOTE: Regardless of what schedule the front panel displays, FS7 is dedicated to initiate only on schedule 20.**

TS1-FS11 AUTOMATICALLY SELECTS AND INITIATES ON 40:

1. Select schedule 40 using the SCHEDULE push-buttons
2. Program SCHEDULE 40 (or a sequence starting at schedule 40 )
3. **Use FS11 to initiate schedule 40 (or a sequence starting at schedule 40).**

**NOTE: Regardless of what schedule the front panel displays, FS11 is dedicated to initiate only on schedule 40.**

## EXTERNAL SCHEDULE SELECT [5.5.] = [0]

In this mode, the initiation (TS-FS3, TS-FS7 AND TS-FS11) inputs are dedicated as follows:

1. INITIATE the selected schedule using FS3.
2. SELECT one of four schedules by an external device or operator acting on TS-FS7 and TS-FS11 as shown on the Table 5.4.3.

**Table 5.4.3** External Schedule select with FS7 and FS11

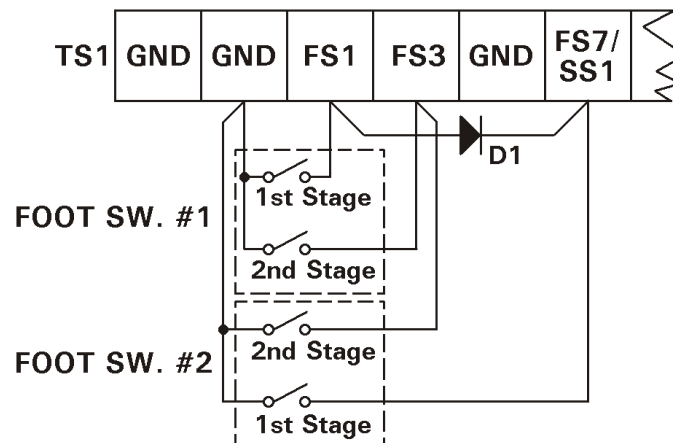
SCHEDULE	TS1-FS7/SS1	TS1-FS11/SS3	INITIATION
00	OPEN	OPEN	FS3
20	CLOSED	OPEN	FS3
40	OPEN	CLOSED	FS3
60	CLOSED	CLOSED	FS3

**NOTE:** In this mode, the operator cannot select schedules using the front panel in OPERATE mode, and can only initiate using FS3. Binary selects FS7 & FS11 must be closed before initiation of FS3 and be opened after sequence is started or completed.

### DUAL TWO-STAGE FOOT SWITCH WITH EXTERNAL SCHEDULE SELECT

The Dual schedule and External Schedule select functions can be combined to allow initiations by means of 2 two-stage foot switches.

Use Schedule 00 for the foot switch #1 sequence and Schedule 10 for the foot switch #2 sequence.



**Figure 5.4.1** Using two two-stage foot initiation

The foot switches, and additional diode assembly A/N 600573, are connected to the TS1 terminal strip as shown on Figure 5.4.1. The diode assembly may be substituted with most any silicon diode rated 1 A at 100 V. See Application Note **700115** .

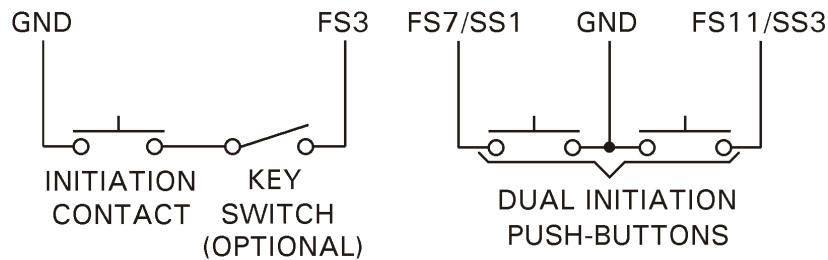
## ANTI-TIEDOWN MODE [5.5.] = [02]

When configuring the control for ANTI-TIEDOWN mode using the TS terminal strip connections, the TS-FS7/SS1 and TS-FS11/SS3 terminals become inputs for ANTI-TIE-DOWN initiations.

1. Use two single pole normally open Push Button Switches connected between TS-FS7/SS1 and TS-GND, and between TS-FS11/SS3 and TS-GND.
2. Set the Schedule Select Extended Function to [5.5.] = [02]

**To initiate a weld using ANTI-TIE DOWN, both switches, FS7/SS1 and FS11/SS3 must be closed within 0.5 seconds of each other.**

If both switches FS7 and FS11 are not closed within 0.5 seconds of each other, the Control will show error [E.r.] = [ - - ]. This error will be cleared after releasing remained closed initiations.



**Figure 5.4.2** *Single Contact and Anti-tiedown initiations*

With ANTI-TIEDOWN operation the machine electrodes will retract if either or both initiation push buttons are released before the end of squeeze time.

To provide both ANTI-TIEDOWN (dual push-button) and SINGLE CONTACT initiations (with lockout), The terminals FS3, FS7/SS1, and FS11/SS3 may be connected as shown on Figure 5.4.2. Only the displayed schedule will initiate by either pressing the FS3 single switch or by using the ANTI-TIE DOWN initiation mode ( FS7/SS1 and FS11/SS3 ).

**NOTE:** The ANTI-TIE DOWN feature AFFECTS CHAINED schedules. It is required that the operator's two hands be on the two palm buttons while the electrodes are closing on the parts to be welded, the palm buttons must be held until the end of the last programmed squeeze time. Otherwise the electrodes will retract prematurely.

Any schedule executed which activates a new valve (chained mode), requires the operator to keep both hands on the switches until after the SQUEEZE time of the LAST schedule that adds any new valves.

## **USING ANTI-TIEDOWN MODE, [5.5.] = [02], WITH S99 OPTION**

If S99 Option board is present and connected to the Control Board, multiple schedule selection is possible even in this mode. After power-up, the Control will automatically detect S99 board, if board is present, and it will enable external binary schedule selection in ANTI-TIEDOWN mode if [5.5.] = 02.

**NOTE:** Starting with software revision 619044-002D, external binary schedule selection is enabled in ANTI-TIEDOWN mode.

## **EXTERNAL BINARY SELECT, S99 OPTION [5.5.] = [03]**

In order to program this extended function parameter, [5.5.] = 03, the S99 option must be present and connected to the Control Board. The option consists of a J4 ribbon cable an additional PCB A/N 410329-004 with six binary schedule select inputs and Control board A/N 600572-009 (EN1001) or 600541-009 (EN1000). These six dry contact closure (approximately 20 Vdc) inputs make all 100 schedules remotely available to the operator or machine process control system.

In this mode, the initiation input, on TS1-FS3, and binary schedule select inputs, on S99 Option Board TS12-SS1-SS32, are dedicated as follows:

1. SELECT one of 99 schedules by an external device or operator acting on TS12-SS1 through TS12-SS32. See S99 Option Application Note 700115 for connection diagram and corresponding schedule table.
2. INITIATE sequence beginning with the selected schedule using FS3.

**NOTE:** In this mode, the operator cannot select schedules using the front panel in OPERATE mode, and can only initiate sequence beginning with dialed schedule using FS3. Function of the other two initiation inputs FS7 and FS11 is unchanged, i.e. FS7 is dedicated to initiate only on schedule 20, and FS11 is dedicated to initiate only on schedule 40.

**NOTE:** If the binary selection inputs provide a decimal equivalent of 100 or above, the Control will display schedule 99.

See Application Note **700115** for more information about S99 Option.

#### 5.4.4 AUTOMATIC VOLTAGE COMPENSATION AND MONITORING - [C.C.]

In addition to the original Automatic Voltage Compensation (AVC), an additional series of settings are available in the EN1000 or EN1001 series of weld controls with software firmware P/N 619044-002 revision A or later. The new settings allow voltage monitoring, or compensation and monitoring.

To program the Automatic Voltage Compensation (AVC) or Voltage Monitoring (AVM):

1. Put the control in PROGRAM Mode.
2. Click SELECT until the DATA display shows [EF].
3. Click the left SCHEDULE push-button until the SCHEDULE display shows [C.C.].
4. Use the DATA Push-Buttons and the tables below to program the desired values.
5. Press ENTER.

Original AVC settings are shown in the following table. These settings are available on all Controls, but they can be used only for compensation, not for monitoring.

AVC parameter [C.C.]	Line Voltage in [VAC]
00	AVC disabled
01	110
02	230
03	380
04	460
05	575

Additional AVC and VM settings are shown in the following table. These settings are available only on Controls with PROM P/N 619016-002 revision A or later.

MONITORING AND COMPENSATION	MONITORING ONLY	THRESHOLD
AVC parameter [C.C.]	AVC Parameter [C.C.]	
10	11	+/- 3%
12	13	+/- 5%
14	15	+/- 10%
16	17	+/- 15%
18	19	+/- 20%
20	21	+/- 25%
22	23	+/- 30%
24	25	+/- 35%
26	27	+/- 40%
28	29	+/- 45%
30	31	+/- 50%

The Automatic Voltage Compensation uses a nominal set point value to determine whether the line voltage is changing during idle periods (between welds). The AVC [C.C.] values must be set during a time in which the line voltage is at this nominal value.

For example: if the plant steady state voltage is approximately 480 VAC, do not program [C.C.] until the line voltage is as close to 480 VAC as possible.

If nominal set point value is too low or too high compared to nominal voltage level, the Control will display one of the following errors:

- [E.r.] = 17      AVC nominal set point voltage is too low, compared to nominal voltage level;
- [E.r.] = 18      AVC nominal set point voltage is too high, compared to nominal voltage level.

To clear these errors, simply press any push button. If either of these two errors occur during [C.C.] programming, the Control will not enable AVC, i.e. [C.C.] will remain zero.

If AVC is enabled, the Control monitors relative line voltage changes from the nominal set point. If the Control detects line voltage changes, it will average these values. When the control is initiated to weld, it compares nominal relative voltage and measured average values to make a correction in the firing angle used for the weld, i.e. to compensate for any line voltage changes.

For [C.C.] values of 10 to 31, the threshold values determine a window within which error messages are not triggered. These values are valid for any voltage level from 110VAC to 575VAC, since the Control uses nominal set point. Any time when [C.C.] is reprogrammed, nominal voltage set point will be reset.

If the line voltage surpasses the threshold, the Control will display an error announcing that the line voltage threshold has been exceeded. If measured average voltage is lower than low window (nominal set points minus threshold), or higher than high window (nominal set points plus threshold), the Control will display one of the following errors:

- [E.r.] = 19      average voltage is below low window (below nominal set point minus threshold);
- [E.r.] = 20      average voltage is above high window (above nominal set point plus threshold).

To clear these errors, simply press any push button.

Several Process Outputs may be programmed for AVC and VM. If either error 19 or 20 occurs, the Control will continue or stop the sequence depending on [P.O.] values.

- [P.O.] = 12      Display Error for 30 cycles (0.5 second) and continue with sequence. PO Valve is off.
- [P.O.] = 10, 13, or 17      Display Error, turn ON the PO Valve for 30 cycles (0.5 second) and continue with sequence.
- [P.O.] = 14      Display Error, turn ON the PO Valve, and STOP the sequence.

## 5.4.5 CLEAR ALL FUNCTIONS - [C.A.]

It is sometimes desirable to CLEAR ALL previous schedules and extended functions from the memory and return the programmed control parameters to factory defaults.

To use the CLEAR ALL feature:

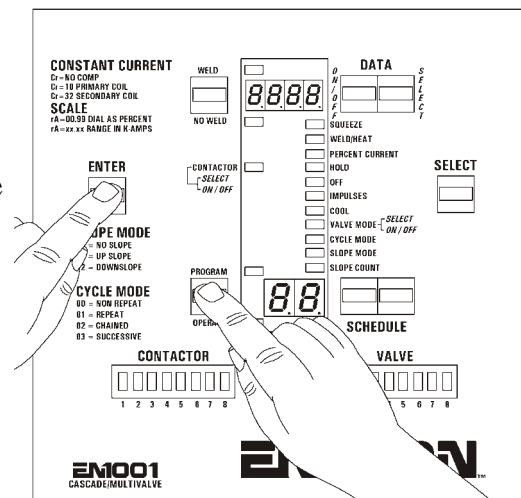
1. Put the control in PROGRAM MODE.
2. Use SELECT to find [EF].
3. Use the SCHEDULE push-buttons to find [C.A.].
4. Enter a value for [C.A.] of [01]
5. Press the ENTER push-button to clear all Schedule Data.
6. Enter a value for [C.A.] of [02]
7. Press the ENTER push-button to clear Extended Function Data.
8. Press the PROGRAM/OPERATE push-button to return the control to the OPERATE mode.

**NOTE: ONCE THE CLEAR ALL FUNCTION IS EXECUTED, ERASED DATA CANNOT BE RESTORED.**

### SHORTCUT TO CLEAR DATA FOR THE CURRENTLY DISPLAYED SCHEDULE

1. Put the Control in the PROGRAM Mode.
2. Press and hold ENTER.
3. Click the PROGRAM/OPERATE button.

All schedule data for the displayed schedule are erased.



**Figure 5.4.3** Clear Schedule Data

### SHORTCUT TO CLEAR ALL EXTENDED FUNCTIONS FROM THE CONTROL

1. Remove all power to the control.
2. Press and hold the PROGRAM/OPERATE push button.
3. Re-Apply power to the control.  
All extended function parameters in the control have been erased.

**NOTE:** After Field Firmware Upgrades, one time Clear All is required when upgrading to a new version of software on ALL older control boards.



## 5.4.6 BACK-STEP / TEMPERATURE LIMIT SWITCH - [b.5.]

The BACK-STEP function is designed to add flexibility while welding with SUCCESSIVE schedules. While active, **[b.5.] steps back to the previous schedule, and allows the operator to initiate on that schedule again while in the middle of a successive sequence.**

As an example, suppose the control executes a sequence and automatically advances the schedule number and flashes schedule [03]. But the operator has executed the sequence in the NO-WELD mode. In this case, the operator must use the BACK STEP switch to STEP BACK from schedule [03]. Put the control in the WELD mode and re-initiate on [02].

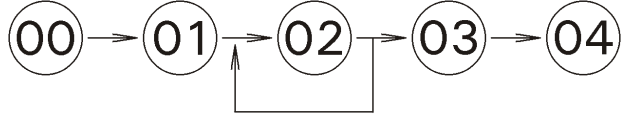


Figure 5.4.4 Back-Step sequence example

To connect the control for BACK-STEP operation, use a normally open switch between TS-WFS1/AUX1 and TS-GND on the terminal strip as a BACK STEP input.

To **program** the control for BACK-STEP operation:

1. Put the control in PROGRAM MODE.
2. Use SELECT to find [EF].
3. Use the SCHEDULE push-buttons to find [b.5.].
4. Enter a value for [b.5.] of: [01] using the DATA push-buttons.
5. Press the ENTER push-button.

When in the BACK-STEP Mode of operation, the switch connected between WFS1/AUX1 and GND must be open for normal operation, and momentarily closed to BACK-STEP one schedule. If left closed, the data display will show ERROR CODE [06] and the schedule display will show [E.r.]. The control has configured the WFS1/AUX1 to GND as an input which looks for a momentary closure.

**NOTE:** If BACK-STEP remains active for more than 1.5 seconds, it will cause the control to return to the first SCHEDULE of either a SUCCESSIVE or CHAINED series and display a flashing error code [E.r.] = 06 in the DATA display, the error code will remain, while the BACK-STEP contact is held closed.

To **restore** the control for Water FLOW Switch operation (default setting):

1. Put the control in PROGRAM MODE.
2. Use SELECT to find [EF].
3. Use the SCHEDULE push-buttons to find [b.5.].
4. Enter a value for [b.5.] of: [00] using the DATA push-buttons.
5. Press the ENTER push-button.

**NOTE:** If Process Output 11 has been selected, the PO output (SV17-SV18) will become energized when switching back to Water FLOW SWITCH Mode. If the control is using the Retraction Process Output [P.O.] = [08], terminal TS-WFS1/AUX1 is used as an input, thus Back step is not available.

## USING BOTH WATER FLOW SWITCH AND BACK STEP FUNCTION

If a Water Flow switch is being used, it can be connected to TS1-NW1 and GND. This is the EXTERNAL NO WELD input. If the Water Flow switch is open, the control will be in a NO WELD condition.

**NOTE:** The Back-Step switch replaces the WFS operation. Alternatively, the Water Flow Switch (WFS) should be connected in series with the Temperature Limit Switch (TLS) or connect the water flow switch to the External No Weld input (NW1) while using the back step option.

### 5.4.7 PROCESS OUTPUTS - [P.O.]

The EN1000 and EN1001 Cascade Controls provide an output that can be useful when the operator or the system needs feedback from specific parts of the welding sequence, such as: Major or minor error conditions to machine controls, shunt trips, or indicator lamps. Some process outputs may result in changes of the control sequence, status, fault, or major or minor error conditions. These changes are intentional with the objective of providing designers with complete flexibility. See the data codes table below.

To use any PROCESS OUTPUT Modes:

1. Put the control in PROGRAM MODE.
2. Use SELECT to find [EF].
3. Use the SCHEDULE push-buttons to find [P.O.].
4. Use the table below as a guide for the necessary process.
5. Press the ENTER push-button.

Valve three may be connected to the shunt trip of a circuit breaker. Under certain conditions as listed below, when a shunt trip breaker is tripped, it is the same as removing power from the control. Most breakers can be equipped with a 110 VAC input shunt trip device. Refer to section 4.3 CUSTOMER TERMINAL STRIP DIAGRAMS AND CONNECTIONS, and the Customer Wiring Diagram.

#### **WARNING:**

**Exercise caution when PO Valve is programmed, the result of its activation could cause a personnel hazard.**

The Valve Control Relay normally incorporated in the standard operation of 1-8 valves is bypassed for PO Valve.

In the Table 5.4.7 are summarized all Process Output Codes. After that follows detailed description of each Process Output.

**Table 5.4.7** Process Output codes and descriptions

CODE	PROCESS OUTPUT DESCRIPTION
00	PROCESS OUTPUT disabled
01	ON during WELD
02	ON during WELD and HOLD
03	ON during HOLD
04	ON during OFF
05	ON after OFF until INITIATION is removed
06	ON for 0.5 sec after EOS (End of Sequence)
07	special AIR over OIL retraction
08	RETRACTION mode
09	HALF Cycle mode
10	ON during ANY Error or when front panel is in “NO WELD” or in PROGRAM Mode, or in constant current mode if current is out of window
11	ON when Temperature Limit Switch is OPEN
12	Flash HI/LO if Current is out of High/Low window
13	Flash HI/LO and PO Valve ON for 0.5 sec if current is out of window
14	Flash HI/LO and break Sequence if Current is out of High/Low window
15	ON for HARDWARE error or ON for CONTROL RELAY error
16	ON for shorted SCR or L2 missing Error ( <b>E.r.</b> =26)
17	ON for following errors: TLS error, error 14, AVC errors, End of Stepper, etc.
18	ON when SCR full conduction is detected ( <b>E.r.</b> =13)
19	ON during WELD only in WELD mode and closed NW1-GND input on TS1
20	Same as PO 28 except evaluated after Weld before Hold.
---	- reserved -
22	Send HI/LO with RS232 or RS485 Option
23	Send HI/LO and Current with RS232 or RS485 Option
24	Flash and Indicate HI/LO if Current is out of window and show Current
25	Indicate HI/LO and EOS; show Current on DATA display
26	Flash HI/LO, Stop sequence, turn PO Valve ON if Current is out of window
27	Flash HI/LO, break seq. and turn PO ON for 0.5 s if Current is out of window
28	Indicate EOS: turn PO Valve ON for 0.5 sec if Current is <b>within</b> the window and Control in WELD mode and closed NW1-GND input on TS1
29	Send HI/LO and Currents for all 8 SCR Contactors with RS485 Option
30	ON if Error 36, i.e. IPSC or IPS error, occurs
31	ON if Error 36, i.e. IPSC or IPS error, occurs at the end of weld
33	ON during ANY Error or when front panel in NO WELD, PROGRAM mode or EMERGENCY STOP. Also Flash HI/LO Stop Sequence, turn PO valve ON for 0.5 sec. if Current is out of window.
34	Flash HI/LO Stop Sequence, turn PO valve ON for 0.5 sec. if Current is out of window.

[P.O.] = [01]

**ON during WELD PROCESS OUTPUT** - When [P.O.] = [01], the PO Valve output will be **on during WELD time** part of the sequence, regardless whether the Control is in Weld or No Weld mode.

[P.O.] = [02]

**ON during WELD AND HOLD PROCESS OUTPUT** - When [P.O.] = [02], the PO Valve output will be **on during application of welding current and the programmed HOLD time**.

[P.O.] = [03]

**ON during HOLD PROCESS OUTPUT** - When [P.O.] = [03], the PO Valve output will be **on during the programmed HOLD Time**.

[P.O.] = [04]

**ON DURING OFF PROCESS OUTPUT** - When [P.O.] = [04], the PO Valve output will be **on during the programmed OFF time** (only valid in repeat sequences).

[P.O.] = [05]

**ON after "OFF" until INITIATION is removed PROCESS OUTPUT** - When [P.O.] = [05], the PO Valve output will turn **ON after the programmed OFF time has elapsed and remain on until the initiation is removed from FS3, FS7 or FS11**.

[P.O.] = [06]

**ON FOR 0.5 SECONDS AFTER END OF SEQUENCE PROCESS OUTPUT** - When [P.O.] = [06], the PO Valve output will turn **ON after the sequence is complete and remain on for one half second**.

[P.O.] = [07]

**Special AIR over OIL RETRACTION PROCESS OUTPUT** - When [P.O.] = [07], the operator can access **additional** Extended Functions parameter **Blocking Delay [b.L.]**.

[P.O.] = [08]

**RETRACTION PROCESS OUTPUT** - When [P.O.] = [08], the PO Valve output will **toggle if TS-WFS1/AUX1 is momentarily closed** to TS1-GND. The control will not initiate if this output is off.

[P.O.] = [09]

**HALF WELD CYCLE Mode PROCESS OUTPUT** - When [P.O.] = [09], and WELD time is 01 cycle, the Control will operate in half-cycle mode.

[P.O.] = [10]

**ANY ERROR PROCESS OUTPUT** - When [P.O.] = [10], the PO Valve output will turn **on if any error is detected also, if the front panel is in a NO WELD condition or in PROGRAM Mode and/or in the event of an EMERGENCY STOP** condition is detected. This process output may be useful when an automated machine is unattended. Under any circumstances, if there is an error to be displayed by the control, the PO Valve output will be energized concurrently with the error message, or in stepper modes during End of Stepper message. This way, the control can advise an Operator, or a Master PLC that an Error has occurred. Also, an un-welded part cannot be fed into the machine following the welder if the PLC receives this signal and halts the subsequent process. Note that this signal will be active if the front panel is in NO WELD, or in PROGRAM Mode.

In addition, after revision 619044-002C in constant current mode with this process output, the Process Output Valve will be ON during HOLD time if Current out of window (HI or LO error) occurs in any schedule of the welding sequence.

[P.O.] = [11]

**TEMPERATURE LIMIT SWITCH OR WFS PROCESS OUTPUT** - When [P.O.]=[11], the PO Valve output will be **on when the WATER FLOW SWITCH input WFS1 is open.**

[P.O.] = [12]

**CURRENT OUTSIDE LIMIT FLASH HI or LO PROCESS OUTPUT** - When [P.O.]=[12], the data display will **flash HI or LO when the control is unable** to keep the current constant within the programmed **HI or LO windows** limits.

[P.O.] = [13]

**CURRENT OUTSIDE LIMIT FLASH HI or LO PROCESS OUTPUT** - When [P.O.]=[13], the four digit data display will **flash HI or LO when the control is unable to keep the current constant within the window limits programmed in HI or LO windows**; In addition, the PO Valve output will turn **ON** for 0.5 second.

[P.O.] = [14]

**CURRENT OUTSIDE LIMIT FLASH HI or LO PROCESS OUTPUT** - When [P.O.]=[14], the data display will **flash HI or LO when the control is unable to keep the current constant within the window limits programmed in HI or LO**. In addition, the CONTROL will **stop a repeat or chained sequence and put the control in NO WELD, after the weld in which the error occurs**. If a sequence is interrupted, the front panel will flash HI/LO message until the operator presses any push-button. After clearing error message on the front panel, WELD/NO WELD push-button must be pressed in order to put Control back in WELD mode. *This Process Output does not use PO Valve for error indication. See [P.O.]=[27] if PO Valve is required.*

[P.O.] = [15]

**HARDWARE ERROR / CONTROL RELAY PROCESS OUTPUT** - When [P.O.]=[15], the PO Valve output will turn **ON if a Control Board error is detected.**

[P.O.] = [16]

**ERROR [E.r.]=26 INDICATION PROCESS OUTPUT** - When [P.O.] = [16], the PO Valve output will turn **ON** if shorted SCR or L2 missing **error, [E.r.]=26, is detected.**

[P.O.] = [17]

**SEVERAL ERROR INDICATION PROCESS OUTPUT** - When [P.O.] = [17], the PO Valve output will turn **ON if following errors are detected:** TLS error, EEPROM error, AVC errors, during End of Stepper message in stepper modes, etc.

[P.O.] = [18]

**ERROR [E.r.]=13 INDICATION PROCESS OUTPUT** - When [P.O.] = [18], the PO Valve output will be **ON** if full SCR conduction **error, [E.r.]=13, is detected.**

[P.O.] = [19]

With this Process Output, PO Valve will be ON during the WELD time of the sequence, only in WELD mode and closed NW1-GND input on TS1. This PO is the same as [P.O.] = 01, except that PO Valve will not be ON if Control is in NO WELD mode or if NW1-GND input on TS1 is open.

[P.O.] = [20]

Same as PO 28 except evaluated after Weld before Hold.

[P.O.] = [22] - Used with RS232 or RS485 Option.

This Process Output will prepare Error Code and Current to be sent to master on ENBUS or to Serial Printer:

Current in [%] or [kA] after end of weld if current was within limits. Error message **E.r.H** if current was above maximum limit and current value in [%] or [kA]. Error message **E.r.Lo** if current was below min. limit and current value in [%] or [kA].

[P.O.] = [23] - Used with RS232 or RS485 Option.

This Process Output will prepare Error Code and Current to be sent to master on ENBUS or to Serial Printer: Error message **E.r.H**, if current was above maximum limit and current value in [%] or [kA]. Error message **E.r.Lo** if current was below minimum limit and current value in [%] or [kA].

[P.O.] = [24]

**CURRENT OUTSIDE OF HI or LO LIMIT PROCESS OUTPUT.** This Process Output uses Valve 1 to indicate HIGH current errors, Valve 2 for LOW current errors, and PO Valve to indicate end of sequence, display measured current on DATA display after end of sequence and display HI or LO if measured current is out of HI/LO window.

[P.O.] = [25]

**INDICATE CURRENT OUTSIDE OF LIMIT and DISPLAY CURRENT PROCESS OUTPUT.** This Process Output uses Valve 1 to indicate HIGH current errors, Valve 2 for LOW current errors, and PO Valve to indicate end of sequence, and will display measured current on DATA display after end of sequence.

[P.O.] = [26]

**CURRENT OUTSIDE OF LIMIT Flash HI or LO, Stop Sequence, and keep PO Valve PROCESS OUTPUT.** This Process Output uses PO Valve to indicate High or Low current errors and stop the sequence until the error is cleared. PO Valve will be ON until error is cleared either by pressing any push-button or E.S. input activation.

[P.O.] = [27]

**CURRENT OUTSIDE OF LIMIT FLASH HI or LO and Stop the Sequence PROCESS OUTPUT** - This Process Output is the same as [P.O.]=[ 14 ], except that in this case the PO Valve output will be **ON** for 0.5 second to indicate High or Low current.

[P.O.] = [28]

**EOS INDICATION IF CURRENT WITHIN THE LIMITS AND CONTROL IN WELD MODE PROCESS OUTPUT.** This Process Output uses PO Valve at the End of Sequence to indicate that Current was *within* the HI and LO limits, and if Control was in WELD mode with closed NW1-GND input on TS1. PO Valve will be ON for 0.5 seconds. In non constant current mode, this Process Output will turn PO Valve ON for 0.5 seconds after EOS only if Control was in WELD mode and closed NW1-GND input. See also PO 20.

[P.O.] = [30] - PO Valve turns ON whenever Error 36, i.e. IPSC or IPS error, occurs.

When the control includes the IPSC or IPS option, the Control may be programmed to indicate whenever any pressure error is detected.

[P.O.] = [31] - PO Valve ON if Error 36, IPSC or IPS error, occurs **after** the weld.

When the Control includes the IPSC or IPS option, and while using this Process Output the control reads the Sensor output **after** the weld portion of the weld sequence and turns the PO Valve on if the trigger value for pressure/force/current is not reached. The trigger values must be programmed within a valid range.

[P.O.] = [33]

**ANY ERROR OR CURRENT OUTSIDE LIMIT FLASH HI or LO PROCESS OUTPUT** - When [P.O.] = [33], the PO Valve output will be **ON** if any error is detected, the front panel is in the NO WELD, in PROGRAM mode and/or an EMERGENCY STOP condition. The PO Valve output will turn **ON** for 0.5 second if the control is unable to keep the current constant within the windows limits programmed in HI or LO. Also the control will stop a repeat or chained sequence and flash HI or LO. If the sequence is interrupted, the front panel will flash HI or LO until someone presses the ENTER button.

[P.O.] = [34]

**CURRENT OUTSIDE LIMIT FLASH HI or LO PROCESS OUTPUT** - When [P.O.] = [34], the PO Valve output will be **ON** for 0.5 second if the control is unable to keep the current constant within the windows limits programmed in HI or LO. Also the control will stop a repeat or chained sequence and flash HI or LO. If the sequence is interrupted, the front panel will flash HI or LO until someone presses the ENTER button.

## 5.4.8 BEAT OPERATION - INITIATION MODES - [b.É.]

The EN1000 Series of controls can provide several INITIATION modes:

- non-beat initiation
- beat initiation during squeeze
- beat initiation during squeeze and weld
- beat initiation during weld with using NW1 input

### NON-BEAT INITIATION MODE, [b.É.] = [00]

The default (Factory Setting) mode is NON-BEAT. In the NON-BEAT mode, **once a sequence is initiated** by a momentary switch closure, **it cannot be stopped unless the EMERGENCY STOP is opened.**

To **program** the control for the default (factory setting) NON BEAT Mode:

1. Put the control in PROGRAM MODE.
2. Use SELECT to find [ÉF].
3. Use the SCHEDULE push-buttons to find [b.É.].
4. Use the DATA push-buttons and make [b.É.] = [00].
5. Press ENTER.

### BEAT INITIATION DURING SQUEEZE, [b.É.] = [01]

BEAT DURING SQUEEZE is typically used with trans-gun applications. Generally, these applications may require that the operator or an external source, **terminate SQUEEZE time before entering the WELD period.** This allows the operator to check tip placement before welding. If the placement is not correct the initiation can be interrupted and the sequence can be terminated; The operator can then reposition the tip.

**NOTE:** If the initiation is opened during the WELD or HOLD period, the sequence will not be interrupted.

To **program** the control for BEAT INITIATION during SQUEEZE:

1. Put the control in PROGRAM MODE.
2. Use SELECT to find [ÉF].
3. Use the SCHEDULE push-buttons to find [b.É.].
4. Use the DATA push-buttons and make [b.É.] = [01].
5. Press ENTER.

**NOTE:** To emulate a two stage pilot, a SINGLE STAGE pilot may be used in this mode of non-interlocked squeeze time, if the pilot is opened during the SQUEEZE, the control will immediately stop the sequence.

Once the WELD time begins, however, the control interlocks the pilot circuit and completes the sequence. **Allow enough squeeze time for the operator to check alignment during SQUEEZE, and open the pilot circuit before the WELD time begins.** This will allow the operator time to reposition the part if the alignment is not proper.

## BEAT INITIATION DURING SQUEEZE AND WELD, [b.É.] = [02]

BEAT DURING SQUEEZE AND WELD Is typically used for brazing applications. It provides the **same functions as provided by Beat During Squeeze; in addition the weld sequence can be terminated before weld time has elapsed.** If the operator opens the initiation during WELD time, the WELD time is interrupted and the control immediately advances to HOLD time. If the initiation switch remains closed, however, the control will WELD normally until the end of the programmed schedule.

This flexibility is required for brazing parts with differing characteristics that require different weld times. The WELD time must be set for the longest time required to bring the parts to the required brazing temperature.

To **program** for BEAT INITIATION during SQUEEZE and WELD:

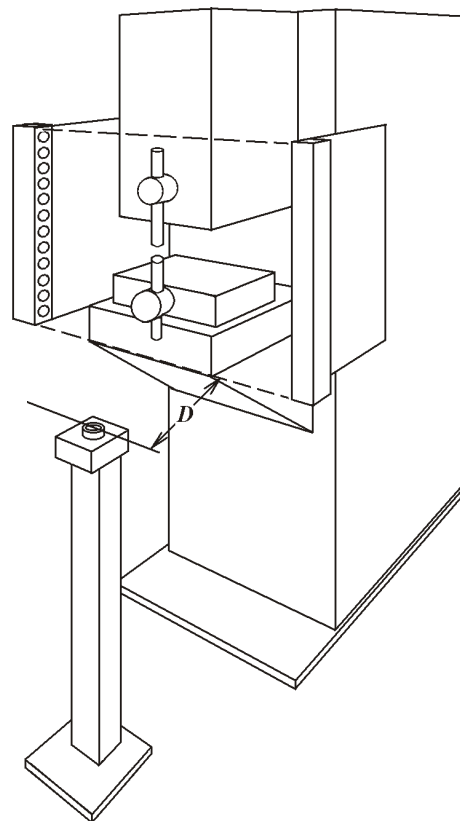
1. Put the control in PROGRAM MODE.
2. Use SELECT to find [ÉF].
3. Use the SCHEDULE push-buttons to find [b.É.].
4. Use the DATA push-buttons and make [b.É.] = [02].
5. Press ENTER.

## NON-BEAT INITIATION MODE, [b.É.] = [03]

In this mode Control will have faster response after Emergency Stop or after power-up, without redundant checking schedules data validity. It will eliminate all unnecessary delays, as well. This mode was added in revision 619044-002A, and it does not affect initiation and Control will operate, after closing initiation, exactly the same as in default non-beat mode [b.É.] = 00, except that Control will be ready for initiation much faster. Faster initialization after closing Emergency Stop input may be very useful when Light-Curtain is used.

When [b.É.] is set to 03 the control will run a faster internal self check after reset. This will reduce the time the control requires to go from an ESTOP condition to a ready to operate condition. This time will range from 30ms to 60ms max. To accomplish this reduced time the redundant schedule data checking has been removed in this Mode. The Schedule Data is still checked before use in a schedule when the weld sequence is initiated. The main reason for this addition is for machine control systems that use the TS1-ES1 and TS1-GND terminals to disable the weld control between initiations.

The standard recovery time of 200ms could add to machine cycle time if [b.É.] is not set to [03]. Before Revision “J”, recovery time was around 500ms. This is especially apparent when light curtains, as shown on Figure 5.4.8, are used to activate the ESTOP circuit.



**Figure 5.4.8** *Using Light Curtain*



How far would the Initiation Button need to be for reliable initiation? Using the following times:

1. Weld control ESTOP response = 60 ms
2. Typical light curtain response = 50 ms
3. Typical speed of travel of hand used in calculations for light curtains is 63 "/sec.

So:

$$D = \frac{63''}{1000ms} \times 110ms = 6.93''$$

Note that this is an estimate based on typical values and does not include switch de-bounce times.

### **BEAT INITIATION DURING WELD USING NW1 INPUT, [b.ε.] = [04]**

Beat during WELD using NW1 input is enabled if [b.ε.] = 04 is programmed. In this mode, when Weld/No Weld input (NW1-GND) is open, the Control will stop welding and jump immediately to HOLD without executing the rest of the WELD part of the sequence.

### **NON-BEAT INITIATION MODE, [b.ε.] = [05]**

In this mode, the Control will allow programming the Cycle mode 05. This mode was added in revision 619044-002C, and it does not affect initiation and Control will operate, after closing initiation, exactly the same as in default non-beat mode [b.ε.] = 00.

### **5.4.9 87° DELAY - [8.7.]**

The 87° Delay helps to prevent the build-up of a DC component in the welding transformer. A DC component may be damaging.

1. Put the control in PROGRAM MODE.
2. Use SELECT to find [ εF ].
3. Use the SCHEDULE push-buttons to find [8.7.].
4. Use the DATA push-buttons and make [8.7.] = [ 00 ] or [ 01 ].

Where:

00 = 87° DELAY DISABLE,

01 = 87° DELAY ENABLE DEFAULT (factory setting).

5. Press ENTER.

**NOTE:** 87° DELAY ENABLE or DISABLE is only operational in manual Power Factor Mode of operation. See section 5.4.10, Manual Power Factor Programming.

#### 5.4.10 MANUAL POWER FACTOR PROGRAMMING - [P.P.]

If required the EN1000/EN1001 Control can be placed in the MANUAL POWER FACTOR Mode as follows:

1. Place the control in the PROGRAM MODE.
2. Use SELECT and find [ **EF** ].
3. Use the SCHEDULE push-buttons to find [ **P.P.** ].
4. Use the DATA push-buttons to **enter the Machine's Power Factor as measured following steps outlined in next section 5.4.11.**

Where:

[ **P.P.** ] = 00 - The Control is in Automatic Power factor mode.

[ **P.P.** ] = XX - If XX is not 00, the Control is in Manual Power factor mode and the Programmed Power factor is XX.

5. Press ENTER.

#### 5.4.11 POWER FACTOR MEASURING - [P.F.]

The EN1000/EN1001 Controls are in the AUTOMATIC POWER FACTOR MODE when shipped from the factory. Calibration of the automatic power factor circuit is not required. This has two benefits:

1. It is not necessary to make manual adjustments when installing the control, to match its circuitry to the POWER FACTOR of the welding machine;
2. It assures that maximum welding current, for any welding transformer tap switch setting, will occur when the selected percent current is 99%.

If desired, for some applications, the AUTOMATIC MODE can be disabled and the machine POWER FACTOR can be set manually. See section 5.4.10. Machine POWER FACTOR can be determined when in the AUTOMATIC POWER FACTOR Mode as follows:

1. Use SELECT to find [ **EF** ].
2. Use the SCHEDULE push-buttons to find [ **P.F.** ].
3. Make a weld.

**At this point, after the weld is complete, the Machine's Power Factor Will be shown in the DATA display. (See the previous section 5.4.10, Manual Power Factor Programming).**

**NOTE:** When measuring the Power Factor, the displayed power factor corresponds to the last weld made by the control.

#### 5.4.12 SQUEEZE DELAY - [5.d.]

SQUEEZE DELAY [5.d.] is a pre-squeeze which energizes the scheduled valves for the programmed interval of time. Squeeze Delay **occurs after initiation and immediately before the first SQUEEZE** is executed, (a form of retraction to position electrodes closer to the work in a “Repeat” sequence).

The length of time added to SQUEEZE time measured in cycles, (60 cycles = 1 second).

After initiation on any of the pilot switches (FS3, etc), the controls display will dim slightly indicating the control is in SQUEEZE DELAY and return to regular intensity for the programmed SQUEEZE time.

**NOTE: SQUEEZE DELAY occurs only before the first SQUEEZE time when in repeat mode.**

#### 5.4.13 BLOCKING DELAY - [b.t.]

This output enables the user of an air-over-oil gun to have a programmed partial retraction in the middle of a sequence. **The output may be turned off by momentarily opening EMERGENCY STOP** terminals TS-ES1 & TS1-GND.

BLOCKING DELAY [b.t.] is an interval of time that **occurs immediately before (overlapping) the programmed OFF time interval.**

When [P.O.] = [07], and delays have been programmed properly, the PO Valve output will turn on during the programmed OFF time, starting at the end of BLOCKING DELAY time. It will remain on after the current sequence until the next initiation occurs.

If the programmed OFF interval is shorter than the programmed BLOCKING DELAY interval, the programmed OFF, will not occur.

If the programmed OFF interval is longer than BLOCKING DELAY, OFF time will be shortened by a time equal to BLOCKING DELAY time. This means that BLOCKING DELAY OVERLAPS "OFF" (after HOLD, coincident with OFF time, that happens only in a sequence of schedules that end with a CYCLE MODE = [00], [01] or [03].

#### 5.4.14 CONSTANT CURRENT MODES - [C.r.] (EN1001 only)

This parameter is used to select desired constant current mode and to select current sensor.

The EN1001 Constant Current control can be programmed for **constant current** operation and two basic modes:

1. Compensation ( both monitoring and compensation),
2. Monitoring (no compensation, only monitoring).

Constant Current operation is possible with three different types of current sensors:

- Primary sensing with Current Transformer.
- Secondary sensing with non-calibrated Hall Effect Sensors.
- Secondary sensing with calibrated Rogowski Coil.

To program the control for CONSTANT CURRENT operation:

1. Put the control in PROGRAM MODE.
2. Use SELECT to find [EF].
3. Use the SCHEDULE push-buttons to find [C.r.].
4. Use the DATA push-buttons to enter one of the desired constant current modes from Table 5.4.14.
5. Press the ENTER push-button.

Table 5.4.14 *Constant Current modes*

[C.r.]	CONSTANT CURRENT	MODE	RANGE
00	disabled CONSTANT CURRENT	---	---
<b>Primary</b> Current Transformer: PT2, PT5, PT10, or PT20			
10	Primary Compensation	any	max. range
11	Primary Monitoring	any	max. range
12	Primary Compensation	PT2	ratio 200 A
13	Primary Monitoring	PT2	ratio 200 A
14	Primary Compensation	PT5	ratio 500 A
15	Primary Monitoring	PT5	ratio 500 A
16	Primary Compensation	PT10	ratio 1000 A
17	Primary Monitoring	PT10	ratio 1000 A
<b>Hall-Effect secondary</b> Current Sensor			
20	Secondary Compensation	max. range	100 kA
21	Secondary Monitoring	max. range	100 kA
<b>Secondary</b> Rogowski Coil: S6 or S10			
30	Secondary Compensation	max. range	up to 100 kA
31	Secondary Monitoring	max. range	up to 100 kA
32	Secondary Compensation	desired range	2 kA to 100 kA
33	Secondary Monitoring	desired range	2 kA to 100 kA

### 5.4.15 RATIO OR RANGE - [*r.R.*] (EN1001 *only*)

This parameter is used in constant current mode to program:

1. **ratio** of the welding transformer for monitoring and compensation with primary current sensor in ratio mode, i.e. for [*L.r.*] = 12, 13, 14, 15, 16, and 17.
2. operating **range**, either in *percent* mode, [*r.R.*]=00.99, or in *kA* mode where [*r.R.*] is maximum RMS current for desired range or transformer tap.

To program the **ratio** or **range** on the EN1001 Series Control in various **constant current** modes:

1. Put the control in PROGRAM MODE.
2. Use SELECT to find [*EF*].
3. Use the SCHEDULE push-buttons to page through the extended functions and find parameter [*r.R.*].
4. Enter a value for [*r.R.*] from the Table 5.4.15, using the DATA push-buttons.
5. Press the ENTER push-button.

The control can be programmed in percent current steps 00.00 to 00.99, or the control can be programmed in steps proportional to a maximum measured current on the secondary of the welding transformer.

Table 5.4.15 *Ratio or Range for Constant Current modes*

[ <i>L.r.</i> ]	CONSTANT CURRENT	[ <i>r.R.</i> ] MODE	[%]	[kA]	rA <sub>WT</sub> *
00	disabled	---	---	---	---
<b>Primary Current Transformer: PT2, PT5, PT10, or PT20</b>					
10	Primary Compensation	max. range	00.99	[xx.xx]	--
11	Primary Monitoring	max. range	00.99	[xx.xx]	--
12,14,16	Primary Compensation	ratio	---	---	up to 0125
13,15,17	Primary Monitoring	ratio	---	---	up to 0125
<b>Hall-Effect secondary Current Sensor</b>					
20	Secondary Compensation	max. range	00.99	[xx.xx]	--
21	Secondary Monitoring	max. range	00.99	[xx.xx]	--
<b>Secondary Rogowski Coil: S6 or S10</b>					
30	Secondary Compensation	max. range	00.99	[xx.xx]	--
31	Secondary Monitoring	max. range	00.99	[xx.xx]	--
32	Secondary Compensation	desired range	---	[xx.xx]	--
33	Secondary Monitoring	desired range	---	[xx.xx]	--

\* Welding Transformer Ratio is:  $rA_{WT} = U_{PRIMARY} / U_{SECONDARY} = I_{SECONDARY} / I_{PRIMARY}$

**NOTE:** When entering *ratios* in the [*r.R.*] parameter, the ratio should be entered as a whole number (if the ratio is 115.5, enter 0115). When entering **range** in kA mode, only numbers representing max. values should be entered as kA (12500 A enter as 12.50).

## 5.4.16 CURRENT OFFSET - [C.O.]

The new Extended Functions parameter [C.O.], Current Offset, provides adjustment CURRENT in either [kA] or [%] in OPERATE mode without going into PROGRAM mode. With this parameter an adjustment limit window is set within which the weld current can be changed. Only weld current can be changed this way and all other schedule parameters remain unchanged. There are two Current Offset Modes, Current Offset for a single schedule, and Current Offset for all schedules.

### Current Offset for Individual or Single Schedules

Changing the current for a schedule only affects the schedule displayed in the schedule window. This is useful when a change is needed because of an individual part change.

### Current Offset for All Schedules

Changing the current for any individual schedule, within the current offset window, will affect all schedules programmed in the Control. Offsetting of all schedules may be useful when a machine function, i.e. a shunt increases in resistance affecting all weld schedules.

### Current Offset Programming

To program the Current Offset Limits:

1. Put the control in PROGRAM Mode.
2. Click SELECT until the DATA display shows [EF].
3. Click the left SCHEDULE push-button until the SCHEDULE display shows [C.O.].
4. Use the DATA push buttons to program the desired values, where:
  - [C.O.]=00 - Current Offset is disabled,
  - [C.O.]=01 to 19 - Current Offset is enabled, ONLY for Single Schedule.
  - [C.O.]=20 - Current Offset is disabled,
  - [C.O.]=21 to 39 - Current Offset is enabled , for ALL Schedules.
5. Press ENTER.

For a Single Schedule the Current Offset [C.O.] may be any value from 00 to 19, and is in units of percent, [%]. This value will set max and min. offset limits for Programmed Current. Current can be changed within these limits without going into PROGRAM mode. When current offset for all schedules is used [C.O.] can have a value from 20 to 39. So if:

- [C.O.] = 20 - Current Offset is disabled.
- = 21 - Current Offset for all schedules  $\pm 1\%$
- = 22 - Current Offset for all schedules  $\pm 2\%$
- “
- ”
- = 38 - Current Offset for all schedules  $\pm 18\%$
- = 39 - Current Offset for all schedules  $\pm 19\%$

On Control Boards with 4 digit Data display, the first digit will be **S**. if  $0 < [C.O.] < 20$  or **A**. if  $20 < [C.O.] < 40$ .

## Using Current Offset

This feature is useful when a Program Lockout Key is used, an operator may change the Current without changing any other welding parameters and without going into PROGRAM mode. The operator may increase the operating Percent Current only up to Base Current plus Current Offset, or decrease the operating Percent Current up to Base Current minus Current Offset.

To change programmed Currents within the Offset Limits in [%] or [kA], in OPERATE mode:

1. Click SELECT until the Indicator LED stops at Percent Current.
2. Use the DATA push buttons to increase or decrease the Percent Current by pressing or holding either Data push button.
3. Press ENTER, only for Constant Current Mode in [k.A.]. For Constant Current Mode in [%] or for non-Constant Current Mode, data will be stored immediately after pressing either Data push button.

**NOTE:** If a value greater than allowed by Max Offset is programmed, the control will store and display the Max Percent allowed. Similarly, if a value is lower than allowed by Min Offset is programmed, the control will store and display the Min Percent allowed.

Current Offset for Single Schedules [C.O.] = [01 to 19]: New weld Percent Current will be only for that schedule.

Current Offset for All Schedules [C.O.] = [21 to 39]: Percent Current will be increased or decreased with the same offset in percent in **all schedules**.

## Changing Base Current

To change base percent currents simply program the schedule as done normally by switching to the PROGRAM mode and following normal programming procedures. In PROGRAM Mode the Display will flash between Base current and Offset current value. Percent Current is the only weld schedule parameter that is changed whenever a Current Offset value is used.

## Current Offset Indication

In the Program Mode: When the Percent Current is displayed, the control will flash if the Current Offset is active. The programmed Base Current is indicated simultaneously with the Schedule number. The Offset Current is indicated simultaneously with [C.O.] in the SCHEDULE window plus either **5.** (Single) or **A.** (All) on the DATA display (non-Constant Current Mode along with the Offset Current value used.

The ENTER push button can be depressed while either of the 2 values are displayed. Pressing ENTER will move the offset current values in to the base % current value. Base value also may be changed by pressing or holding Data push buttons and then pressing ENTER.

## Current Offset Examples

1. [**C.O.**]=00      Current Offset is disabled. The Current cannot be changed in OPERATE mode.
2. [**C.O.**]=05  
or  
[**C.O.**]=5.05  
[%] mode      Current Offset is +/-5%. For Single Schedule the Current can be changed in OPERATE mode within 10% window, i.e. up to +/-5% from original base value programmed in PROGRAM mode.  
For example: For an original base Weld Current value of 70%, a new values may be from 65% to 75%.
3. [**C.O.**]=25  
or  
[**C.O.**]=R.25  
[%] mode      Current Offset is +/-5%. For All Schedules the Current can be changed in OPERATE mode within 10% window, i.e. up to +/-5% from original base value programmed in PROGRAM mode.  
For example: For an original base Weld Current value of 70%, a new values may be from 65% to 75%.
4. [**C.O.**]=05  
or  
[**C.O.**]=5.05  
[kA] mode      Current Offset is +/-5%. For Single Schedule the Current can be changed in OPERATE mode within 10% of maximum RMS current window, i.e. up to +/-5% from original value programmed in PROGRAM mode.  
For example: For an original base Weld Current value of 14.00 kA, and maximum RMS is 20.00 kA, a new values may be from 13.00 kA to 15.00 kA, (because 5% of 20.00 kA is 01.00 kA).



## 5.4.17 PIN LOCKOUT MODE

This feature has been added in revision 619044-002A and it does not require any hardware change or additional option. Operation of the hardware Program Lockout key, when used, has not been changed.

### Enabling PIN Lockout

To enable PIN Lockout Mode, 4-digit PIN number must be programmed:

1. Put the control in PROGRAM Mode.
2. Click SELECT until the DATA display shows [ **EF** ].
3. Scroll through Extended Functions using the right SCHEDULE push-button until the SCHEDULE display shows [ **P.n.** ].
4. Use the DATA Push-Buttons to program desired 4-digit PIN from **0001** to **9999** .
5. Press ENTER.
6. Program all other desired Schedule or Extended Functions parameters.
7. Put the control back in PROGRAM Mode. After PROGRAM/OPERATE push-button is released, the Control will flash on DATA displays [ **L.o.c.** ], which will indicate that PIN lockout mode is enabled.

After the last step, Control will be locked from going into PROGRAM mode. To unlock Control, entering correct PIN is required or use of Program Lockout Key switch when used.

### Unlocking Control using PIN

In order to go in PROGRAM mode when Control is locked, correct PIN must be entered:

1. Click SELECT until the DATA display shows [ **EF** ].
2. Scroll through Extended Functions using the right SCHEDULE push-button until the SCHEDULE display shows [ **P.n.** ]. On DATA displays Control will show [ **0000** ] and PIN will be hidden.

**NOTE:** Whenever PROGRAM/OPERATE push-button is pressed, while Control is locked with PIN, the Control will flash for half a second on DATA displays [ **P. n.** ] and PROGRAM LED will flash as well, and Control will go immediately to Extended Function parameter [ **P.n.** ].

3. Use the DATA Push-Buttons to enter PIN.
4. Press ENTER. After this push-button is released:
  - if correct PIN is entered, the Control will flash on DATA displays [ **u.L.o.c.** ], and it will go immediately in to PROGRAM mode;
  - if incorrect PIN is entered, the Control will flash on DATA displays [ **D.o.P.S.** ].
5. After programming all desired Schedules or Extended Functions parameters, new PIN may be entered or the old one will be applied when Control is put back in OPERATE mode.

### Disabling PIN Lockout

To disable PIN Lockout Mode or delete PIN, simply use the clear of all Extended Functions data, by entering [ **C.R.** ] = **02**, or by pressing and holding PROGRAM/OPERATE push-button during power-up or after E.S. reset. This may be also very useful whenever the PIN is lost.

**NOTE:**The Control is shipped from the factory in the **disabled** PIN Lockout mode.

## 6. GENERAL OPERATING INSTRUCTIONS

For your convenience, many electrical and mechanical connections have been performed at the factory. Refer to CUSTOMER WIRING DIAGRAM for other connections.

Be sure **ALL electrical connections are properly made** and that all fittings are securely tightened. Loose electrical connections can cause faulty or erratic operation of the control or welding machine.

If the machine is air operated, **turn on the air supply** to the machine. Set air pressure in accordance with the machine manufacturer's recommendations.

**Be sure that the welding machine heads are fully retracted. Turn on MAIN POWER.** The Schedule and Data displays will turn on at this time.

**Place the control in NO WELD.** Use either the front panel's WELD/NO WELD switch or the external WELD/NO WELD switch connected to the Terminal Strip between NW1 and GND.

### 6.1 WELD SEQUENCE EXAMPLE

Program a simple SINGLE SPOT schedule into the control as follows:

SQUEEZE count	30 to 60 cycles
WELD /HEAT count	12 to 25 cycles
PERCENT CURRENT	50 to 60%
HOLD count	10 to 15 cycles
OFF count	00 cycles
IMPULSES	01 (no impulses)
COOL count	00 cycles
VALVE MODE	01 (valve #1)
CYCLE MODE	00 (non repeat)
SLOPE MODE	00 (no slope)
SLOPE COUNT	00 cycles
CONTACTOR SELECT	01 (SCR #1)

1. Initiate the control. On installations with a two stage pilot switch, **depress the first stage only. The programmed valve will activate. The control will not sequence through Squeeze, Weld, Hold and Off.** Be sure that the electrodes have closed together prior to depressing the second stage.
2. **The control will sequence but will not weld,** and then the head or arms will retract. On single stage operation, **closure of the pilot switch will cause the control to sequence.** On foot operated machines only, a switch on the mechanical linkage of the machine will initiate the sequence.

## CAUTION

KEEP HANDS, ARMS, OTHER PORTIONS OF THE BODY, CLOTHING, AND TOOLS AWAY FROM THE MOVING PARTS OF THE MACHINE.

3. Program the schedule for the part to be welded. Place the work in the machine and set the WELD/NO WELD switch (both on control panel and any EXTERNAL WELD/NO WELD switches) to the WELD position. The machine is ready to weld.
4. If no standards have been set, it is recommended to use a short weld count for initial setup and welding. Weld count can be increased, the percent current can be adjusted, and welding transformer tap (if applicable) can be increased for the best weld. **The most efficient use of the control and welding machine will generally be made at the lowest welding transformer tap, the highest percent current setting and the shortest weld count.**
5. **For repeat operation, program CYCLE MODE to [01],** and program OFF count to allow sufficient time to reposition the part for subsequent welds.

## 6.2 CYCLE MODES

The EN1000/EN1001 can be programmed to operate in several operating modes. They are: Non-Repeat, Repeat, and Successive. Each of the 100 possible schedules has a cycle mode parameter that dictates the sequence of events that will follow an initiation.

The cycle modes are as follows:

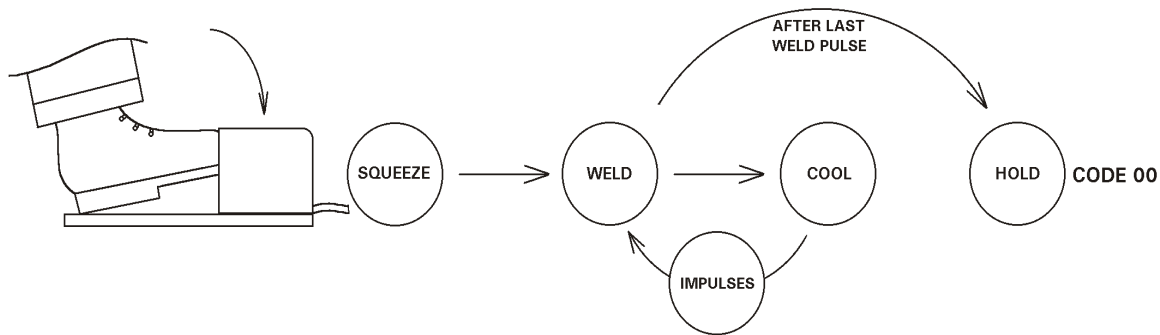
- [00] = **Non-Repeat**
- [01] = **Repeat**
- [02] = **Chained**
- [03] = **Successive**
- [04] = **Conditional Successive**
- [05] = **Wait-Here**

The CYCLE MODE parameter is entered into a schedule when the control in the “Program”(23) mode with the “CYCLE MODE” LED (16) is illuminated.

### 6.2.1 NON REPEAT - CODE [00] IN CYCLE MODE

When any of the 100 possible Schedules, having a cycle mode setting of [00], is initiated by a pilot switch, the sequence executes as shown in the Figure 6.1 (depending on the programmed parameters).

Upon initiation, the programmed valve is energized at the beginning of Squeeze. If the Pressure Switch is “open” the control counts through the Squeeze time but does not begin counting Weld time until the Pressure Switch closes. If the Pressure Switch remains open the SQUEEZE LED will flash. Once the Pressure Switch closes, the Weld time begins. Weld current is then supplied to the welding transformer at a value programmed by the PERCENT CURRENT for a duration programmed in WELD.

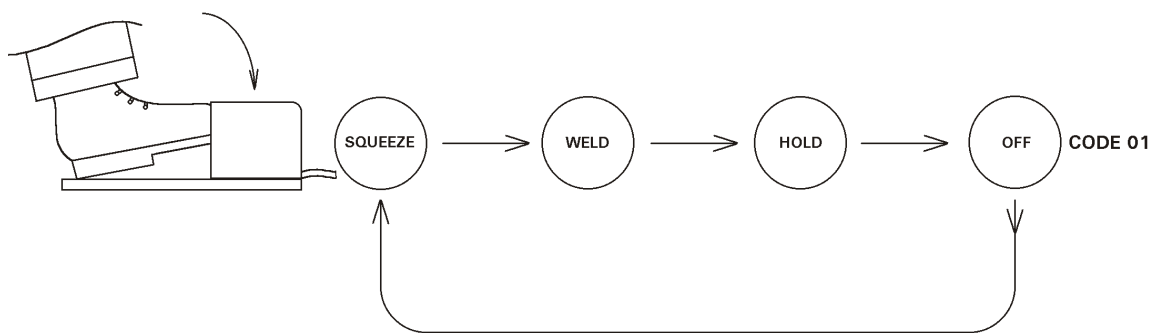


**Figure 6.1** *Non Repeat sequence*

In this example, pulsation is shown after Cool, until the number of Impulses has elapsed, then moving to Hold. Hold time is when the electrodes are closed with no current present, but the selected valve will still be energized. Since this is a Non-Repeat sequence, there is no Off time mentioned. The valve will automatically de-energize at the end of the programmed Hold time.

### 6.2.2 REPEAT - CODE [01] IN CYCLE MODE

When any of the 100 possible Schedules, having a cycle mode setting of [01], is initiated by a pilot switch the sequence is as shown in the following diagram, Figure 6.2.



**Figure 6.2** *Repeat sequence*

In this example, the sequence is much the same as the previous example with the exception of no Impulse welding. If the initiation (Foot Switch) is held closed until after the Off time, the control will move to the beginning of Squeeze time and REPEAT the scheduled sequence.

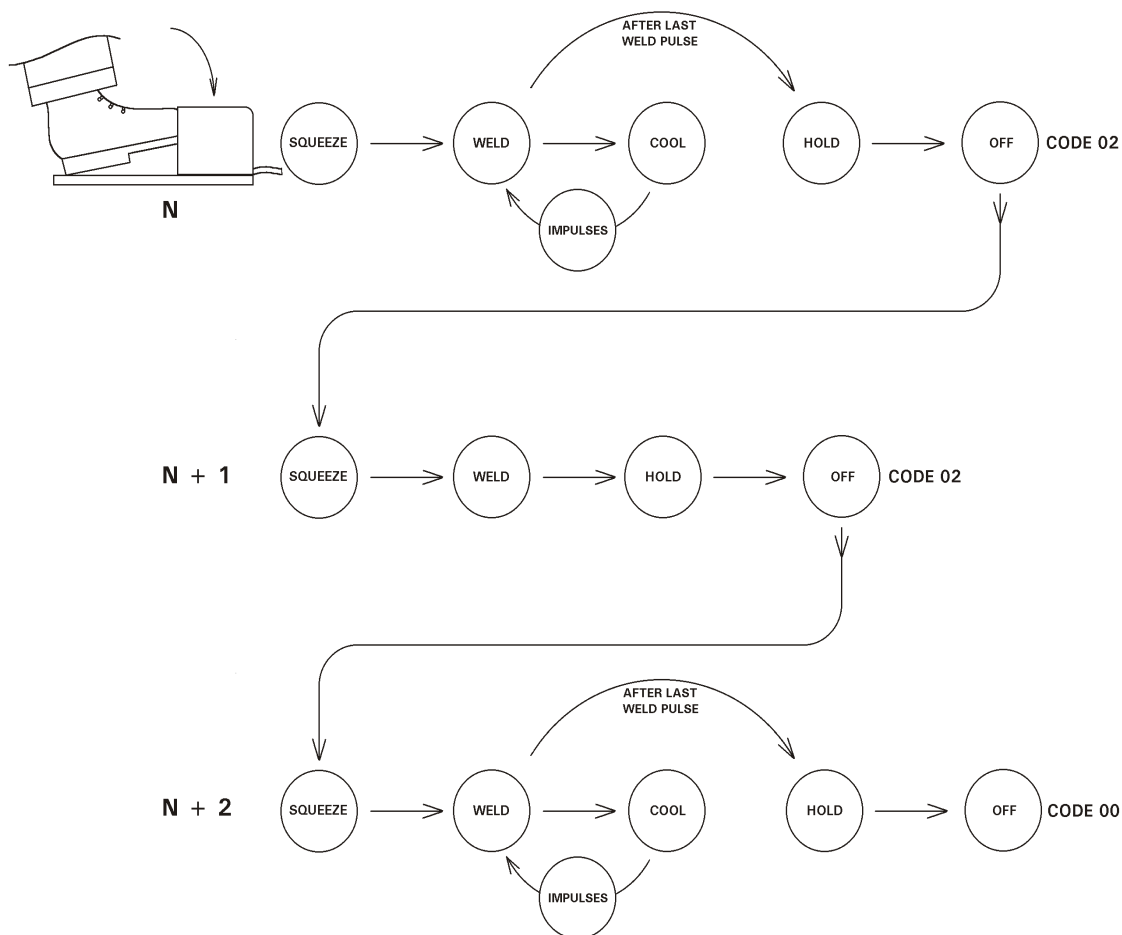
Each individual sequence intended to REPEAT must be programmed separately for a CYCLE MODE [01] to perform a REPEAT function.

### 6.2.3 CHAINED MODE - [02] IN CYCLE MODE

Scheduled sequences may be CHAINED, resulting in a weld sequence made up of several Schedules in length. A CHAINED sequence can be programmed by entering [02] in CYCLE MODE. The last scheduled sequence must be a CYCLE MODE value of [00] (Non Repeat), [01] (Repeat), or [03] (Successive).

If CYCLE MODE [01] is used in the last schedule of a chained sequence, the entire chain will be repeated if the initiation is held closed.

Select the first Schedule of a CHAINED sequence in the example below can be any of the 100 possible. In CYCLE MODE [02] a scheduled sequence is CHAINED immediately to the next schedule (numerically 23 . . 24 . . 25, etc.). When initiated (Foot Switch), the following sequence takes place, as shown on the Figure 6.3.



**Figure 6.3** Chain sequence

**NOTE:** The first Schedule of the CHAINED sequence is called "N".

While SCHEDULE "N" is sequencing, the times and parameters will be in accordance with those stored in SCHEDULE "N". When "N" has finished, the sequence jumps to SCHEDULE "N+1". SCHEDULE "N+1" is then performed and so on until the sequence encounters a [00],[01], or [03] in the CYCLE MODE FUNCTION. The various Cycle modes will cause the sequence to continue in the following manner.

Within the CHAINED sequence the control will encounter SCHEDULES programmed with the following CYCLE modes and will react as follows :

**[00] NON REPEAT:** The sequence will end in NON REPEAT mode. The SCHEDULE Display will then return to the first initiated sequence.

**[01] REPEAT:** The sequence will start over at the initiated sequence and continue as explained in CHAINED Mode.

**[02] CHAINED:** The SCHEDULE SELECT display will increment by one and continue as explained in CHAINED Mode.

**[03] SUCCESSIVE:** The sequence will end as if it were in NON REPEAT mode. The SCHEDULE display would then be incremented by one to next Schedule as in SUCCESSIVE Mode but not start that sequence until the next initiation. By using **[03]** at the end of CHAINED SEQUENCES, extremely complicated sequences can be generated. The SCHEDULE Display will display the Schedule number of the last Schedule performed + 1.

**[04] CONDITIONAL SUCCESSIVE:**

The sequence will start over at the initiated sequence.

**[05] WAIT-HERE:**

The sequence will wait for FS7 or FS11 initiation input.

When Hold and Off in the first SCHEDULE of a chained sequence and Squeeze in the second of the chained sequence are all programmed to 00 cycles, the sequence will jump directly from the end of WELD Time of the first SCHEDULE to the beginning of WELD Time in the following SCHEDULE, without any interval between the two WELD Times (continuous weld current). This sequence allows two different weld currents to be introduced with one immediately following the other.

The SCHEDULE number displayed at the end of a CHAINED SEQUENCE depends on the EXTENDED FUNCTION [5.5.] INTERNAL/EXTERNAL. If it was programmed in the EXTERNAL mode, the SCHEDULE number displayed will be controlled by the combination of SS1, SS2 (See Section 2.1 CONTROL FUNCTIONS/SCHEDULE NUMBER SELECTION). If it was programmed to the INTERNAL mode, the SCHEDULE number will be the last number entered using keys (21) and (20). The number displayed need not be the first number in a sequence of CHAINED SCHEDULES. For example, if SCHEDULES 01, 02, 03 and 04 are chained together and we select SCHEDULE 02, after initiation the sequence would be as follows: SCHEDULE 02, 03, 04 and at the completion of SCHEDULE 04, the SCHEDULE Display would read 02., and not the first SCHEDULE 01. See section 5.4 EXTENDED FUNCTIONS and section 5.4.3 SCHEDULE SELECTION.

#### **6.2.4 SUCCESSIVE MODE - [03] IN CYCLE MODE**

SUCCESSIVE MODE can be thought of as a CHAINED schedule being initiated one link (or step) at a time. When the first SCHEDULE of a SUCCESSIVE series is initiated, it will sequence as in NON REPEAT. At the completion of the SCHEDULE the SCHEDULE Display will be incremented by one and the control will return to the READY state.

For example, if the control is programmed with a SUCCESSIVE series consisting of the SCHEDULES 01, 02, and 03 (01 and 02 being programmed as SUCCESSIVE SCHEDULES and 03 being programmed as a NON REPEAT SCHEDULE) and the SCHEDULE SELECT display is manually set to 01 and the control is initiated, the sequence of events will be as follows; the control will sequence through SCHEDULE 01 and then increment the SCHEDULE Display to 02 (flashing) and wait for the next initiation.

An initiation at this point would start SCHEDULE 02. After SCHEDULE 02 was completed, the SCHEDULE Display would then increment to SCHEDULE 03 (flashing). After the next initiation SCHEDULE 03 will be completed and the SCHEDULE Display will again show SCHEDULE 01.

When the EXTENDED FUNCTION [5.5.] SCHEDULE SELECT INTERNAL/EXTERNAL MODE is programmed to the EXTERNAL [01] Mode, the SUCCESSIVE series will start with the externally selected SCHEDULE and will automatically return to that SCHEDULE once the series is completed. See section 5.4 EXTENDED FUNCTIONS.

The BACK-STEP FUNCTION can be used to return to the previous SCHEDULE "N-1" without continuing through the rest of the SUCCESSIVE SCHEDULES. A momentary closure of the BACK-STEP (WFS1/AUX1) switch will cause the control to return the previous SCHEDULE. This can be repeated until the first SCHEDULE of a series is reached. A maintained closure (approximately 1.5 seconds) will cause the control to return the first SCHEDULE in the series. If the BACK-STEP switch is maintained after the control reaches the first SCHEDULE, an error code [E.r.] = 06 will flash in the DATA display.

### 6.2.5 CONDITIONAL SUCCESSIVE MODE - [04] IN CYCLE MODE

The Cycle mode 04, Conditional Successive Mode, has been implemented to complement Chained and Successive sequences with a third type which combines the benefits of both.

The control will execute the given schedule, and at the end of HOLD will maintain the schedule valves active. At this point, the control will wait in this state and indicate the state by blinking the front panel HOLD-LED. If the control is initiated a second time, when the initiation input closes the control will continue by selecting the next schedule and executing it as programmed.

**NOTE:** If a momentary initiation was used to begin the current schedule, the control will wait until a new initiation is asserted. If the initiation was held closed until this point, the control will wait until the initiation is opened and a new initiation is asserted.

### PART LOCATOR AND CLAMP

In some cases fixturing may require a locating pin be extended to accurately locate a part before welding. The following shows how three schedules can be programmed using various cycle modes to accomplish this function.

#### Part Locator

Schedule 00 is programmed to energize valve 1 in order to actuate a **part locator**. Initially, the valve is active for 60 Cycles, 40 Cycles of Squeeze and 20 Cycles of Hold (One Second). At the end of this time, the control blinks the HOLD Led and waits for further input, i.e. for re-initiation.

SCHEDULE	SQUEEZE	WELD/HEAT	PERCENT CURRENT	HOLD	OFF	IMPULSES	COOL	VALVE MODE	CYCLE MODE	SLOPE MODE	SLOPE COUNT
00	40	00	00	20	00	01	00	01	04	00	0

At this point, the Operator can Load a part and initiate the next sequence by opening and closing the foot-switch.

#### Clamp Valve

When the Operator Closes the foot-switch again, the control activates the following chained schedule immediately. During the second Schedule, the control adds a second valve to the first, **the Clamp Valve**.

SCHEDULE	SQUEEZE	WELD/HEAT	PERCENT CURRENT	HOLD	OFF	IMPULSES	COOL	VALVE MODE	CYCLE MODE	SLOPE MODE	SLOPE COUNT
01	40	00	00	20	00	01	00	03	02	00	0

## Cascade Welds

The third and fourth schedules (02 and 03 ), execute a Squeeze, Weld and Hold using the valve 03. Valves 1 and 2 are still active (Position and Clamp). In this sequence we just add valve 3. Valve 3 closes a pair of guns connected to each of the two welding transformers. After the control executes a Weld on contactor 01, the sequence continues on Schedule 03, where the control makes a similar weld using contactor 02.

The fifth and sixth schedules (04 and 05 ), execute another Squeeze, Weld and Hold using valve 04. In this sequence Valve 3 is de-energized. Valve 4 activates a second pair of guns connected to the two transformers. Again, the control welds using contactor 1 and chains to contactor 2 to execute the third and fourth welds.

SCHEDULE	SQUEEZE	WELD/HEAT	PERCENT CURRENT	HOLD	OFF	IMPULSES	COOL	VALVE MODE	CYCLE MODE	SLOPE MODE	SLOPE COUNT	CONTACTOR SELECT
02	40	10	70	05	00	01	00	<b>07</b>	02	00	00	01
03	00	10	70	05	00	01	00	<b>07</b>	02	00	00	02
04	40	10	70	05	00	01	00	<b>0B</b>	02	00	00	01
05	00	10	70	05	00	01	00	<b>0B</b>	00	00	00	02

Variations in the above sequence can be accomplished using other cycle modes and valve modes. Since the valve codes are in *binary* form, valve assignments are clarified in Table 6.1, in Section 6.4.

### 6.2.6 WAIT-HERE MODE - [05] IN CYCLE MODE

This cycle mode has been implemented to satisfy additional requirements for more complicated machine sequencing.

**NOTE:** The Control will allow programming of Cycle mode 05 *only* if Extended functions parameter Beat mode is already programmed to [b.É.] = 05.

If a schedule is programmed with Cycle mode 05 and if initiated by FS3 initiation, the Control will execute the schedule sequence, and it will wait either in SQUEEZE or WELD-COOL or HOLD part of the sequence, depending on programmed data in the given schedule, and it will maintain the schedule valves active indefinitely. At this point WAIT-HERE part of the sequence can be stopped by activating ES or TLS input, or it can be continued with FS7 or FS11 initiation. When the FS7 or FS11 initiation input closes, the control will continue by selecting the schedule 10 or 20, respectively, and executing it as programmed whether it is a spot or repeat or chain sequence.

In order to determine where Control will wait in cycle mode 05, corresponding schedule parameter must be programmed to 99. The Control will wait on Squeeze, if SQUEEZE is programmed to 99, or Weld/Cool if Impulses is 99 or Hold if HOLD is 99.

The following table illustrate an example how to use this cycle mode.

SCHEDULE	SQUEEZE	WELD/HEAT	PERCENT CURRENT	HOLD	OFF	IMPULSES	COOL	VALVES	CYCLE MODE	SLOPE MODE	SLOPE COUNT
00	30	00	00	00	00	01	00	1	02	00	00
01	20	00	00	10	00	01	00	1,2	04	00	00
02	30	00	00	00	00	01	00	1,2	02	00	00
03	10	20	60	10	00	99	06	1,2,3	05	00	00



After welding sequence is started with FS3, the Control will execute a chain on schedule 00, wait for re-initiation on schedule 01, execute chain on schedule 02 and then it will weld indefinitely on schedule 03 (because of Cycle mode=05, and Impulses=99). It will continue to weld until ES or TLS is open, sequence will be stopped, or until FS7 or FS11 is activated, the Control will jump to schedule 10 or 20, respectively, and execute whatever sequence is programmed there. In this case for schedule 03, Squeeze time must be less than 99 cycles, otherwise the Control will wait on SQUEEZE. In order to wait on HOLD, both Squeeze and Impulses must not be programmed to 99.

#### **WARNING**

By definition, use of this cycle mode can cause Control to “latch up” with programmed valves or welds for an indeterminate time. Welding sequence cannot be stopped by releasing FS3 initiation in this mode. Only either FS7 or FS11 input can be used to jump to sequences on schedule 20 or 40, respectively, or TLS or ES inputs to stop the sequence.

### **6.3 SLOPE MODES**

The EN1000 Series of weld controls offer UP SLOPE and DOWN SLOPE as standard features for applications that require its use.

Up/Down-Slope Control provides a means of gradually increasing or decreasing weld current. How gradual the increase or decrease occurs is determined by the slope bottom current and the number slope cycles programmed in Slope Count. The number programmed into Slope Count will determine the rate at which the control will reach the programmed Weld current. Slope Count is programmable from 01 to 99 cycles.

When Slope Mode is used, its function is to change the current gradually. The Up-Slope mode causes the current to start from a low level and increase for a predetermined number of cycles. When Down-Slope is in use, the reverse is true. Current will start to decrease to low level for a predetermined number of cycles. The number of Slope Cycles is automatically added to the number of Weld cycles.

**Example:** If fourteen (14) cycles of UP-Slope are programmed in Slope Count, for Slope Mode 01 or 02, and the number of Weld cycles is twenty-one (21), the total amount of Weld time is thirty-five (35) cycles.

The ENTRON Up-Slope and Down-Slope Control are sequential. The Up-Slope Count and Down-Slope Count setting and the Weld Count times are independent of each other. Adjusting either of the Slope Counts or Weld Count does not affect the setting or operation of the other switch setting. No arithmetic is involved in setting the Slope control.

#### **6.3.1 NO SLOPE - [00] IN SLOPE MODE**

When a [00] is programmed, slope is disabled. **The output of the Welding Transformer may look like a natural UP SLOPE waveform.** The welding transformer secondary load characteristics will affect the rate at which this ‘Natural Up-slope’ occurs.

#### **6.3.2 UP SLOPE - [01] IN SLOPE MODE**

When [01] is selected and the control initiated, UP SLOPE will occur before WELD. If the Control Sequence is REPEAT Mode or PULSATION Mode, the UP SLOPE will only occur before the first WELD IMPULSE. If in INTERMITTENT or CONTINUOUS SEAM Mode UP SLOPE will only occur when first initiated.

When single schedule is used to program UP SLOPE and WELD as a part of weld sequence, Schedule **10** in below example, starting percent current by default is equal to one quarter of Percent Current. In this example, for Schedule 10, starting current is:  $60\%/4 = 15\%$ ; and Percent Current increment is:  $(60\% - 15\%)/09 = 5\%$ .

SCHEDULE	SQUEEZE	WELD/ HEAT	PERCENT CURRENT	HOLD	OFF	IMPULSES	COOL	VALVE MODE	CYCLE MODE	SLOPE MODE	SLOPE COUNT
<b>10</b>	10	26	60	20	00	01	00	01	00	<b>01</b>	09
...										...	
<b>11</b>	10	00	30	00	00	01	00	01	02	<b>01</b>	15
<b>12</b>	00	20	75	20	00	01	00	01	00	<b>00</b>	00

Schedules **11** and **12** in previous example are used to show how two chained schedules can be used to program UP SLOPE and WELD part of the weld sequence with any other values for starting percent current. In this example, for Schedule 10, starting current is:  $30\%$ ; and Percent Current increment is:  $(75\% - 30\%)/15 = 3\%$ .

### 6.3.3 DOWN SLOPE - [02] IN SLOPE MODE

When [02] is selected and the control initiated, DOWN SLOPE will occur after WELD. If the control is in REPEAT Mode or PULSATION Mode, the DOWN SLOPE will only occur after the last WELD IMPULSE. For example, if the SCHEDULE has programmed 10 cycles of DOWN SLOPE and 25 cycles of weld, the DOWN SLOPE will start after WELD. The complete weld and down slope time would add to 35 cycles. If in INTERMITTENT or CONTINUOUS SEAM Mode DOWN SLOPE will only occur when the last initiation, with a programmed DOWN SLOPE, is removed.

SCHEDULE	SQUEEZE	WELD/ HEAT	PERCENT CURRENT	HOLD	OFF	IMPULSES	COOL	VALVE MODE	CYCLE MODE	SLOPE MODE	SLOPE COUNT
<b>20</b>	10	25	80	20	00	01	00	01	00	<b>02</b>	10
...										...	
<b>21</b>	10	20	75	00	00	01	00	01	02	<b>02</b>	15
<b>22</b>	00	00	15	20	00	01	00	01	00	<b>00</b>	00

Schedule **20** in used to show how DOWN SLOPE and WELD parts of the sequence are programmed in the single schedule. The bottom percent current by default is equal to one quarter of Percent Current. In this example, for Schedule 20, starting current is  $80\%$  and bottom current is:  $80\%/4 = 20\%$ ; and Percent Current increment is:  $(80\% - 20\%)/10 = 6\%$ .

Schedules **21** and **22** in previous example are used to show how two chained schedules can be used to program WELD and DOWN SLOPE parts of the weld sequence with any desired values for bottom percent current of last down slope pulse. The bottom current is  $10\%$ , and Percent Current increment is:  $(75\% - 15\%)/15 = 4\%$ .

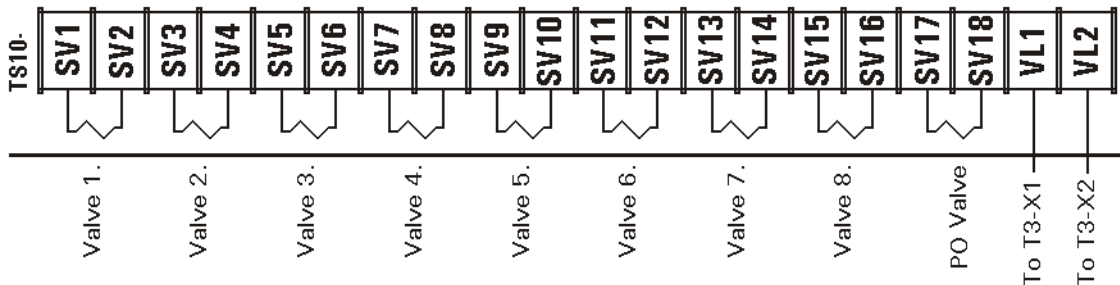
## 6.4 VALVE MODES

Each schedule programmed can have any one of the eight valve outputs (or none) enabled during its schedule. The eight solenoid valves are activated based on the VALVE Mode programmed as shown in Table 6.1.

**Table 6.1** Valve Codes and Valve outputs

Valve Code right digit	Valves LED 4 3 2 1	Description	Valve Code left digit	Valves LED 8 7 6 5	Description
00	0 0 0 0	Four valves off	00	0 0 0 0	Four valves off
01	0 0 0 1	Valve 1	10	0 0 0 1	Valve 5
02	0 0 1 0	Valve 2	20	0 0 1 0	Valve 6
03	0 0 1 1	Valves 1 & 2	30	0 0 1 1	Valves 5 & 6
04	0 1 0 0	Valve 3	40	0 1 0 0	Valve 7
05	0 1 0 1	Valves 1 & 3	50	0 1 0 1	Valves 5 & 7
06	0 1 1 0	Valves 2 & 3	60	0 1 1 0	Valves 6 & 7
07	0 1 1 1	Valves 1,2 & 3	70	0 1 1 1	Valves 5,6 & 7
08	1 0 0 0	Valve 4	80	1 0 0 0	Valve 8
09	1 0 0 1	Valves 1 & 4	90	1 0 0 1	Valves 5 & 8
0a	1 0 1 0	Valves 2 & 4	a0	1 0 1 0	Valves 6 & 8
0b	1 0 1 1	Valves 1,2 & 4	b0	1 0 1 1	Valves 5,6 & 8
0c	1 1 0 0	Valves 3 & 4	c0	1 1 0 0	Valves 7 & 8
0d	1 1 0 1	Valves 1,3 & 4	d0	1 1 0 1	Valves 6,7 & 8
0e	1 1 1 0	Valves 2,3 & 4	e0	1 1 1 0	Valves 6,7 & 8
0f	1 1 1 1	Valves 1,2,3, & 4	f0	1 1 1 1	Valves 5,6,7, & 8

When in the PROGRAM Mode and selection of a valve code is being made, the VALVE LED indicators will indicate the selected valve(s). The valve(s) output will not be energized while in PROGRAM Mode.



**NOTE:** The valve codes shown in Table 6.1 are same for Valves 9-16 on 410322-001 Board. Refer to Application Note 700146 for further information on the use of Cascade 9-16 Valve Extension Option.

## 7. STEPPER ON EN1000/EN1001 SERIES CONTROLS

Up to **ten** steppers may be programmed on the EN1000 or EN1001 Cascade series of weld control.

The Weld Stepper may be used to compensate the gradual deformation of a welding machine's electrodes. This deformation occurs because of the repeated application of heat and pressure to the relatively soft electrode material, resulting in a broadening of the electrode face (mushrooming) with continued usage. The increasing face diameter results in a decreasing current density, which eventually reaches a point where satisfactory welds can no longer be made. At this time, the weld current setting must be adjusted upwards or the electrodes must be re-dressed before further use.

The Weld Stepper increases the number of satisfactory welds that can be made without re-dressing the electrodes, by increasing the welding current in steps as the mushrooming progresses. This action maintains the current density fairly constant for a relatively large number of welds. The Stepper can be programmed to change not only the welding current, but also the weld time, and even the complete welding schedule if desired.

Each of the steppers may have up to maximum ten steps, and each step may be programmed from 0000 to 9999 welds.

The Stepper can also be programmed to provide an electrical output after the last step to sound an alarm to alert the operator that the electrodes need to be re-dressed or replaced. After end of last step, stepper can be reset manually or automatically.

The Stepper may be useful when welding complex multiple spot sequences. On a large welded assembly for example, several welds may require a given time and current setting and then several more welds may require a different time and current setting, continuing in this manner through several changes in welding parameters.

Each of the steppers may also be used as simple weld count down-counter.

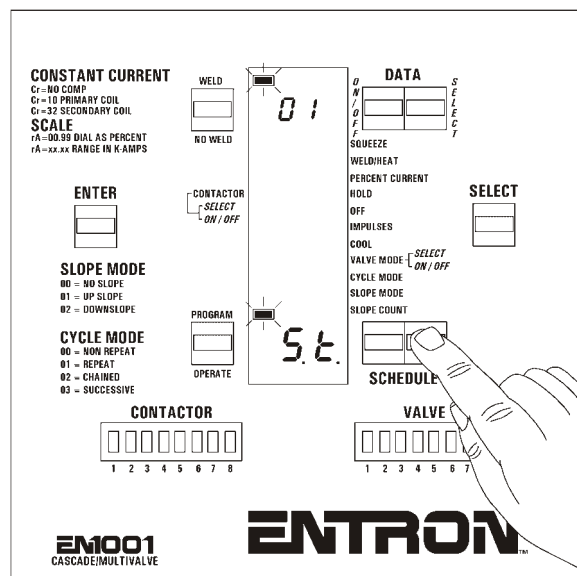


Figure 7.1 Stepper enabling

**NEW:** In software revision 619044-002B, a new stepper mode has been added, stepper mode [S.t.]=02, for single stepper counter with multiple steps and any possible schedule sequence combination.

Stepper counter will be decremented during welding sequence only if weld was made, i.e. weld time and weld current must be programmed, and control must be in the weld mode (external Weld/No weld switch, if used, must be closed and front panel Weld/No Weld led indicator must be in weld mode).

## 7.1 SCHEDULE MAP

Since up to ten steps may be programmed per stepper in Stepper Mode 01, ten schedules are assigned for each stepper, as illustrated in the Table 7.1.

**Table 7.1** Schedule Map used for stepper programming

STEPPER	SCHEDULES	WELD STEPS		Last Step	Last Count	INITIATION
		STEP	COUNT			
0	00	0.0	0000 to 9999	[L.S.] 00 to 09	[L.C.] 0000 to 9999	FS3
	01	0.1				
	02	0.2				
	03	0.3				
	04	0.4				
	05	0.5				
	06	0.6				
	07	0.7				
	08	0.8				
	09	0.9				
1	10	1.0	0000 to 9999	[L.S.] 10 to 19	[L.C.] 0000 to 9999	FS3
	11	1.1				
	12	1.2				
	13	1.3				
	14	1.4				
	15	1.5				
	16	1.6				
	17	1.7				
	18	1.8				
	19	1.9				
2	20	2.0	0000 to 9999	[L.S.] 20 to 29	[L.C.] 0000 to 9999	FS3 or FS7
	21	2.1				
	22	2.2				
	23	2.3				
	24	2.4				
	25	2.5				
	26	2.6				
	27	2.7				
	28	2.8				
	29	2.9				
◆	◆	◆	◆	◆	◆	◆
---	---	---	---	---	---	---
◆	◆	◆	◆	◆	◆	◆
9	90	9.0	0000 to 9999	[L.S.] 90 to 99	[L.C.] 0000 to 9999	FS3
	91	9.1				
	92	9.2				
	93	9.3				
	94	9.4				
	95	9.5				
	96	9.6				
	97	9.7				
	98	9.8				
	99	9.9				

For Stepper Mode 02, the same schedule map is used as in mode 01, except that only **one** stepper counter exists with all schedules from 00 to 99, with maximum of 100 steps.

## 7.2 STEPPER PROGRAMMING

### 7.2.1 EXTENDED FUNCTION PROGRAMMING

Stepper enable [5.t.] Extended Function parameter is used to **enable** stepper.

1. Click the SELECT push button until SLOPE COUNT is reached, then click once more.
2. Press the SCHEDULE push buttons to find [5.t.] in the schedule display.
3. Program the required values according to the following table.
4. Press ENTER push button.

EF parameter [S.t.]	STEPPER	Description
00	disable	Stepper operation is disabled.
01	enable	Multiple Steppers with max. 10 steps per stepper.
02	enable	Single Stepper counter with multiple steps.

### 7.2.2 WELD SEQUENCE PROGRAMMING

1. Put the control in PROGRAM mode by clicking PROGRAM/OPERATE push button.
2. Using standard programming procedure, program all weld sequence parameters for first schedule for desired stepper.
3. Using *copy schedule* front panel shortcuts, i.e. press ENTER and right SCHEDULE push button in program mode, copy current schedule to the next one and repeat this as many times as number of steps is necessary for that stepper.
4. Percent Current or Weld Heat must be adjusted in each next step after the first one.
5. Put the control in OPERATE mode by clicking PROGRAM/OPERATE push button.

### 7.2.3 STEP COUNTS PROGRAMMING

1. Using the SCHEDULE push buttons, set the **first** schedule for desired stepper, e.g. for stepper **0**, first schedule is **00**.
2. Put the control in PROGRAM mode by clicking PROGRAM/OPERATE push button.
3. Click the SELECT push button until WELD/ HEAT parameter is reached, Fig. 7.2.
4. Program the required WELD time for the weld sequence, e.g. **04** cycles.
5. Press the SCHEDULE push buttons to find [**0.0**] in the SCHEDULE display, Fig. 7.3.

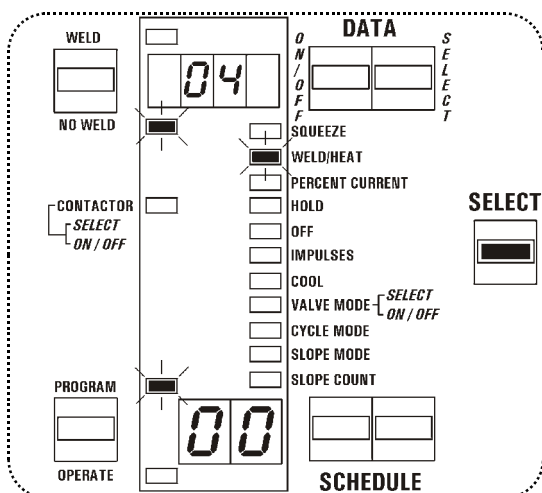


Figure 7.2 Select WELD/HEAT

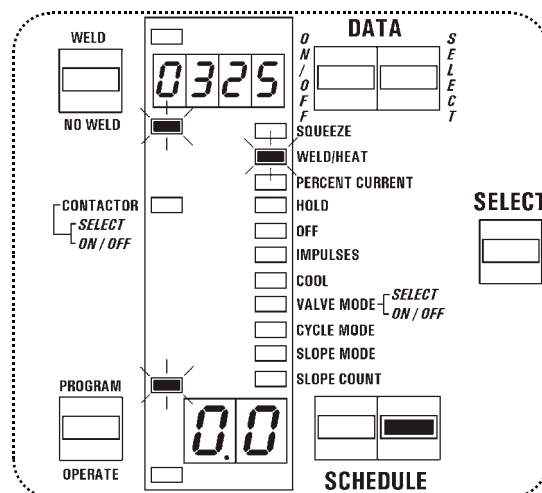


Figure 7.3 Program weld count

6. Program the required WELD COUNT for this step, e.g. **0325** welds.
7. Click SELECT push button to find CURRENT and program the required CURRENT in [%] or [kA] for this step of the weld sequence.
8. Put the control in OPERATE mode by clicking PROGRAM/OPERATE push button.
9. For programming all other steps from [0.1] to [0.9], increase the schedule number and repeat all previous procedures from 2 to 8.

## 7.2.4 LAST STEP AND LAST COUNT PROGRAMMING

1. Dial any schedule from schedule map for desired stepper. For example, for stepper mode 01 and stepper 0, any schedule from 00 to 09, for stepper 1, any schedule from 10 to 19, etc. For stepper mode 02, dial any schedule.

2. Put the control in PROGRAM mode.
3. Press the SCHEDULE push buttons to find [L.5.] in the SCHEDULE display, as shown on Figure 7.4.

4. Program the desired last step for this stepper, e.g. for stepper 0 last step in stepper mode 01 may be any number from 00 to 09, as shown on Figure 4, but in stepper mode 02 it may be any schedule number from 00 to 99. In fact, this value will be first step at beginning of the weld sequence. This value will be reset or reprogrammed after resetting the stepper.

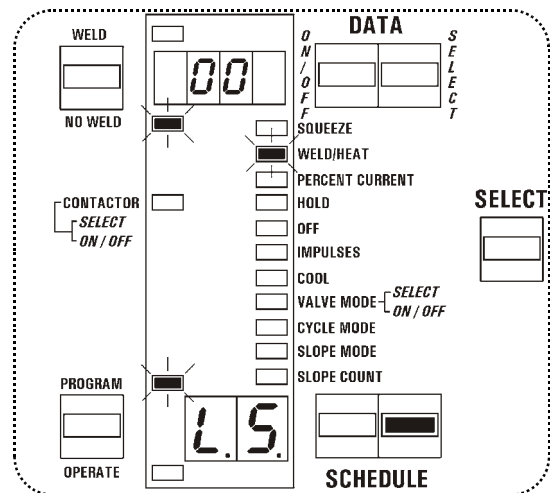


Figure 7.4 Program last step

5. Program the desired last count for this stepper, e.g. for stepper 0, last count may be any number from 0000 to 9999, as shown on Figure 7.5. In fact, this value will be first count at beginning of the weld sequence. This value will be reset or reprogrammed after resetting the stepper.

6. Put the control back in OPERATE mode.

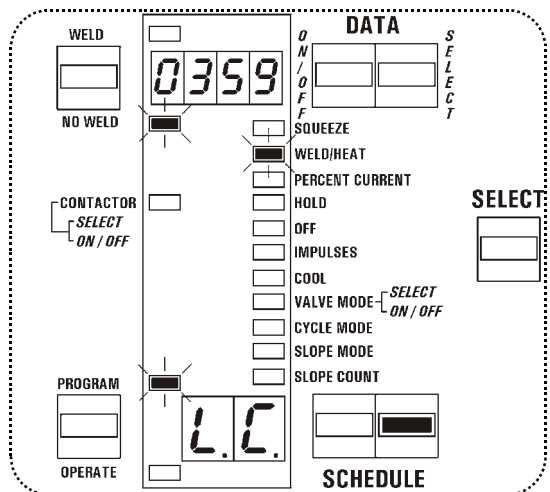


Figure 7.5 Program last count

## 7.3 SEQUENCE INITIATION IN STEPPER MODE

### 7.3.1 SCHEDULE SELECT OPTIONS FOR STEPPER MODE [5.t.]=01

Since the Stepper requires certain specific starting Schedules, the Schedule Select function [5.5.] with Stepper mode **01** is described in the following sections for Internal schedule selection, External schedule selection, or S99 Option.

#### Internal Schedule Select Option - [5.5.]=00

As shown in the schedule map table, each of the ten steppers can be initiated with the FS3 initiation switch. This is possible only if any of the ten possible schedules for desired stepper is dialed on the SCHEDULE displays.

Besides FS3 initiation, steppers 2 and 4, can be initiated with FS7 and FS11 initiation switches. FS7 is dedicated to initiate only stepper **2** (schedule 10 to 19) regardless of what schedule is dialed on SCHEDULE displays. FS11 is dedicated to initiate only stepper **4** (schedule 40 to 49) regardless of what schedule is dialed on SCHEDULE displays.

#### External Schedule Select Option - [5.5.]=01

In this mode, only four steppers can be initiated with the FS3 initiation switch. This is possible only if FS7 and FS11 are used for stepper selection, as shown in the next table.

STEPPER	SCHEDULE	FS7/SS1	FS11/SS3	INITIATION
0	00	OPEN	OPEN	FS3
2	20	CLOSED	OPEN	FS3
4	40	OPEN	CLOSED	FS3
6	60	CLOSED	CLOSED	FS3

#### Anti Tiedown Option - [5.5.]=02

In this mode, any stepper can be initiated with the both FS7-FS11 initiation switches. The stepper operation is the same as with standard FS3 initiation.

#### External Schedule Select with S99 Option - [5.5.]=03

In this mode, any of five steppers can be initiated with FS3 initiation switch. The stepper selection is possible with closing one of the SS1, SS2, SS4, or SS8.

STEPPER	SCHEDULE	SS1	SS2	SS4	SS8	SS16	SS32	SS64	INITIATION
0	00	0	0	0	0	0	0	0	FS3
1	10	1	0	0	0	0	0	0	FS3
2	20	0	1	0	0	0	0	0	FS3
3	30	0	0	1	0	0	0	0	FS3
...	...	...	...	...	...	...	...	...	...
7	70	0	0	0	0	0	0	1	FS3

### 7.3.1 SCHEDULE SELECT OPTIONS FOR STEPPER MODE [5.t.]=02

**NOTE:** Stepper counter will be decremented *only* if FS3 (or both FS7 and FS11 in ANTI-TIEDOWN mode) is used for initiation.

When either FS7 or FS11 is used for initiation in the mode 02, stepper counter will not be decremented, and Control will execute the welding sequence starting with schedule 20 or 40, respectively. But, when S99 Option is used for External schedule selection, [5.5.]=03, after FS7 initiation, the Control will execute any selected schedule, instead of schedule 20.





## 7.4.2 STEPPER OPERATION FOR STEPPER MODE [5.t.]=02

In this mode, the maximum number of steps is 100, which is possible only if a single schedule is used per step. If more chained schedules are required in a welding sequence, the number of steps is determined by the number of chained schedules used in each step.

The algorithm is almost identical to the one used for stepper mode 01, shown in Figure 7.6, except that only **one** stepper counter is used and when the Last Step is incremented, the Control will check if that number is greater than the maximum number of schedules, 99 in this case, and then show End of Stepper message, if necessary. Also, stepper counter will be decremented only if FS3 (or both FS7-FS11 in anti tiedown mode) is used for initiation.

The following table demonstrates this mode with 5 chained schedules per step or welding sequence. Weld count **must** be programmed in the first schedule of the chained sequence. Following the last step, the next schedule should be empty, in this example schedule 17. If weld count in that schedule is 0000 that will indicate End of Stepper, [5.t.] - [E.n.d.] .

SCHEDULE	SQUEEZE	WELD/HEAT	WELD STEP	STEPS COUNT	PERCENT CURRENT	HOLD	OFF	IMPULSES	COOL	VALVE MODE	CYCLE MODE	SLOPE MODE	SLOPE COUNT	CONTACTOR
<i>first</i> step: last step is [L.5.]=00, and last count [L.C.] will be from 0325 to 0000														
00	40	00	0.0	0325	00	20	00	1	00	1,8	02	00	00	1
01	10	25	0.1	xxxx	60	10	00	1	00	1,2,8	04	00	00	1
02	10	00	0.2	xxxx	00	00	00	1	00	1,8	02	00	00	1
03	30	20	0.3	xxxx	50	10	00	1	00	1,2	03	00	00	1
04	10	00	0.4	xxxx	00	00	00	1	00	1,2,3	00	00	00	1
<i>second</i> step: last step is [L.5.]=05, and last count [L.C.] will be from 0250 to 0000														
05	40	00	0.5	0250	00	20	00	1	00	1,8	02	00	00	1
06	10	25	0.6	xxxx	65	10	00	1	00	1,2,8	04	00	00	1
07	10	00	0.7	xxxx	00	00	00	1	00	1,8	02	00	00	1
08	30	20	0.8	xxxx	55	10	00	1	00	1,2	03	00	00	1
09	10	00	0.9	xxxx	00	00	00	1	00	1,2,3	00	00	00	1
<i>third</i> step: last step is [L.5.]=10, and last count [L.C.] will be from 0195 to 0000														
10	40	00	1.0	0195	00	20	00	1	00	1,8	02	00	00	1
11	10	25	1.1	xxxx	70	10	00	1	00	1,2,8	04	00	00	1
12	10	00	1.2	xxxx	00	00	00	1	00	1,8	02	00	00	1
13	30	20	1.3	xxxx	60	10	00	1	00	1,2	03	00	00	1
14	10	00	1.4	xxxx	00	00	00	1	00	1,2,3	00	00	00	1
<i>fourth</i> step: last step is [L.5.]=15, and last count [L.C.] will be from 0150 to 0000														
15	30	20	1.5	0150	75	10	20	1	00	1,2,3	01	00	00	1
<i>fifth</i> step: last step is [L.5.]=16, and last count [L.C.] will be from 0001 to 0000														
16	30	00	1.6	0001	00	00	00	1	00	7,8	00	00	00	1
17	00	00	1.7	0000	00	00	00	1	00	00	00	00	00	00

NOTE: If Stepper reset is performed by holding ENTER and pressing both DATA push buttons at the same time, the Last Step will be [L.5.]=00 in this example, and Last Count [L.C.]=0325, no matter which schedule is dialed on front panel display.

## 7.5 STEPPER RESET

### 7.5.1 MANUAL STEPPER RESET

1. Dial any schedule from schedule map for desired stepper. For example, in stepper mode 01 for stepper **0**, dial any schedule from **00** to **09**; in stepper mode 02, dial any schedule.
2. Put the control in PROGRAM mode.
3. Press and hold the ENTER push button. While holding the ENTER push button, press both DATA push buttons **at the same time and hold momentarily**. After this, Last Step [**L.5.**], and Last Count [**L.C.**], parameters will be initialized with appropriate values programmed for first step, e.g. for stepper **0**, last step will now be [**L.5.**]=**00**, and last count [**L.C.**]=**0325**. The Stepper will be reset only if all three push buttons are properly pressed. After reset, both initialized parameters will be displayed on the SCHEDULE and DATA displays for a short period of time. These two parameters may be reprogrammed by entering desired values and pressing ENTER, at any time, without resetting stepper using all three push buttons.
4. Put the control back in OPERATE mode.

**NOTE:** Stepper reset may be performed not only by holding ENTER and pressing both DATA push buttons at the same time, but also by manual programming of the Last Step [**L.5.**], and Last Count [**L.C.**], for corresponding stepper.

### 7.5.2 AUTOMATIC STEPPER RESET

When necessary, the stepper can be automatically reset by adding the RESET command using an additional schedule after the last step. The RESET command is simply an empty schedule, no valves, no other parameters, except for the OFF time. If the stepper counter reaches zero on the last step, the Control will read the next schedule. If it finds the RESET command, it will reload the stepper automatically. Any new sequence will start again on the first step.

To enable automatic stepper reset:

1. Display the next schedule after the last schedule from schedule map, for desired stepper.
2. Put the control in PROGRAM mode.
3. Clear all parameters for that schedule. In Program Mode, the *delete* shortcut may be used by holding ENTER and pressing the PROGRAM/OPERATE push button.
4. Make sure that the WELD COUNT is 0000 for this step.
5. Program the OFF time = 99 cycles.
6. Put the control back in OPERATE mode.

If necessary, a warning signal may be added just before the RESET command. Simply add an additional step with a very low weld count, for example 0010 welds. This schedule may contain an additional valve output which may be used to warn the operator by means of light or some other alarm device. For example:

SCHEDULE	...	WELD STEPS		...	OFF	...	VALVE MODE	description
		STEP	COUNT					
00		<b>0.0.</b>	0325				1	Step 1
01		<b>0.1.</b>	0400				1	Step 2
02		<b>0.2.</b>	0450				1	Step 3
03		<b>0.3.</b>	0010				1,2	Pre-warning step, adding Valve 2 output
04		<b>0.4.</b>	0000		99		00	RESET Command (all other parameters 00)

### 7.5.3 STEPPER RESET USING EXTERNAL SWITCH INPUT

From Software revision 619044-002E, it is possible to use external RESET input momentary **normally closed** switch, connected between ES1-GND terminals on TS1 to automatically stepper reset. To enable external reset with ES1 input, the Extended Function parameter [b.É.] must be programmed to 06. Whenever momentary switch is activated (open) the Control will automatically reset active stepper.

### 7.6 USING THE STEPPER AS A COUNTER

The Stepper counter may be used as a down-counter. It is simply necessary to load a schedule stepper counter with a value to countdown from. The maximum allowable value is 9999. This function may be used in a single weld schedule, such as 00, 10, 20, 30, or 40, or any welding sequence starting with those schedules.

1. Select the Schedule to be used.
2. Put the control in PROGRAM mode.
3. Enable Stepper by Programming [5.É.] = 01 or [5.É.] = 02.
4. Program the WELD schedule as required.
5. Select the WELD parameter again.
6. Find [2.0.], [b.0.], etc. (by pressing the RIGHT Schedule Push-button).
7. Program the desired count in the Data display [0000] to [9999] (Press ENTER).
8. Reset the Stepper by pushing ENTER, and the two DATA Push-buttons *Simultaneously*.
9. Put the control back in OPERATE mode.

**NOTE:** If necessary, the message [5.É.] [É.n.d.] may be shown at the end of the countdown. Select the next Schedule and clear it by using the Clear Schedule Data Shortcut shown on page 47. Program a Weld time of 01 cycles and return to the operating schedule.

### 7.7 DISPLAYING THE STEPPER COUNT DURING OPERATION

The stepper count may be displayed during operation if necessary. Since this is not a principal Weld function, the access to the display requires the following:

1. Select the Schedule to be used.
2. Put the control in PROGRAM mode.
3. Select the WELD parameter.
4. Find [L.L.], by pressing the RIGHT Schedule Push-button.
5. Put the Control back in Operate Mode.

The Last Count number will be shown after end of each welding sequence.

### 7.8 END OF STEPPER

When last step is reached, the Control will flash the message [5.É.] [É.n.d.] on displays. This message can be cleared by pressing any front panel push-button on or by activating E.S.

If [P.0.] is programmed to 10 or 17, Process Output Valve, or PO Valve, will be active as long as message [5.É.] [É.n.d.] is flashing on displays.

## 8. CONSTANT CURRENT OPERATION (EN1001 *only*)

To operate the control with Constant Current, it is necessary to be familiar with the operation of the control in non-constant current mode.

The function of the Current compensation feature of the EN1001 series controls is that of maintaining the welding current constant at the preset level, despite influencing factors which could otherwise make the current vary.

With the current compensation feature in operation, the current remains substantially constant regardless of line voltage variations, changes in machine power factor caused by movement of ferrous metal within the secondary, or changes in the size or shape of the secondary, or changes in material resistance, or any combination of these factors.

The current compensation feature **should not be expected to correct for electrode wear, improper electrode size or force**, or other problems caused by improper machine setup and maintenance.

Constant Current operation is possible with three different types of current sensors:

1. Primary sensing with Current Transducer.
2. Secondary sensing with non-calibrated Hall Effect Sensor.
3. Secondary sensing with Rogowski Coil.

### 8.1 INTRODUCTION TO CONSTANT CURRENT OPERATION

In Constant Current EN1001 there are two basic modes:

- [%] mode** if [r.R.] = 00.99 - current is programmable in percent steps from 0000 (0 %) to 0099 (99%);
- [kA] mode** current programmable in [kA] from 00.00 (0 A) to 99.99 (99,990 A), using the four digit data display.

Based on current sensor and desired constant current modes, program one of the modes from the Table 5.4.14 or Table 5.4.15.

#### 8.1.1 SHOW CURRENT ON THE DISPLAY AFTER THE WELD

It is not necessary to program any special function or Process Output to display current after the weld. Simply use the SELECT push-button to indicate Percent Current before initiation. The control will display the measured current at the end of the sequence.

Before initiation of the sequence Select Percent Current using the SELECT push-button. After the end of sequence, the DATA display may show average RMS current in [kA] or [%]. If necessary, the control will display the range or tap indicator, [t.-UP] or [t.-dn], messages. The display may be toggled between current in [kA] and real phase shift percent firing in [%] by pressing the DATA push buttons as follows:

- Pressing DATA 1'S push button will show percent phase shift;
- Pressing DATA 10'S push button will show last measured current in [kA];
- Pressing any other push button will clear the display.

The following messages are readily available at the end of the sequence.

### **Average RMS Current in [kA]**

Average RMS Current in [kA] is shown on the display if the control is operating in the proper mode and a weld has been made. A valid operating for [kA] display is any mode that allows programming the control in [kA] in the weld schedule.

### **Phase Shift in [%]**

Phase Shift in [%] is selectable only if an RMS Current is displayed at the end of a weld. To show the Percent Phase shift simply press the DATA 1's push-button. This is useful to determine if the control has enough headroom to compensate for current losses whenever needed.

### **Toggle between RMS Current in [kA] and Phase Shift in [%]**

RMS current in [kA] and Phase Shift in [%] are selectable only if an Average RMS Current is displayed at the end of a weld. To show the Percent Phase shift simply press the DATA 1's push-button, and to show last measured RMS current in [kA] simply press the DATA 10's push-button. To clear display, press any other push-button.

### **Tap UP (or Range DOWN) indicator**

Tap UP or Range Down message [**t-UP**] is shown at the end of a weld sequence if the weld control is unable to compensate and maintain the programmed current. In this case, moving the Tap selector, if exists, to a higher setting will allow the control to maintain the current constant. If the machine is already at the highest tap setting, the maximum current range of the machine is much lower than the programmed range in [**r.R.**]. In this case, choose a lower current range from the table and program the corresponding value in [**r.R.**].

Phase Shift in [%] and RMS current in [kA] are also available during this condition. To show the Percent Phase shift while [**t-UP**] is displayed, simply press the DATA 1's push-button. To show the RMS current in [kA], simply press the DATA 10's push-button. To clear display, simply press any other push-button.

### **Tap DOWN (or Range UP) indicator**

Tap Down message [**t-dn**] is shown at the end of a weld sequence if the weld control is unable to compensate and maintain the programmed current. In this case, moving the Tap selector, if exists, to a lower setting will allow the control to maintain the current constant. If the machine is already at the lowest tap setting, the maximum current range of the machine is higher than the programmed range in [**r.R.**]. In this case, choose a higher current range from the table and program the corresponding value in [**r.R.**].

Phase Shift in [%] and RMS current in [kA] are also available during this condition. To show the Percent Phase shift while [**t-dn**] is displayed, simply press the DATA 1's push-button. To show the RMS current in [kA], simply press the DATA 10's push-button. To clear display, simply press any other push-button.

## 8.1.2 USING THE CONSTANT CURRENT PROCESS OUTPUTS

The EN1001, while in any Constant Current mode, can be programmed to provide always, no matter what is shown on display before beginning of weld sequence, a weld current readout at the end of any sequence. Several Constant current Process Outputs function as defined in section 5.4.7 and can be programmed to function as follows.

To obtain an **End of Sequence Readout**, find [**P.O.**] in the Extended Functions and program a value of [**P.O.**] = 12.

While in the constant current mode, Control will measure the value of current maintained during the weld and show this value on DATA display at the end of the sequence.

If a window is being monitored for HI/LO range, the value shown on the display will be the current maintained by the control if the control can maintain this value. If the control cannot maintain the set current value, **the control will flash LO or HI** (depending on the case).

To obtain an **End of Sequence Readout and Process Output Valve, i.e. PO Valve, alarm output**, find [**P.O.**] in the Extended Functions and program a value of [**P.O.**] = 13.

While in the constant current mode, Control will measure the value of current maintained during the weld and show this value on DATA displays at the end of the sequence.

If a window is being monitored for HI/LO range, the value shown on the display will be the current maintained by the control, if the control can maintain this value. If the control cannot maintain the set current value, **the control will flash LO or HI** (depending on the case). **In addition, the Control will turn PO Valve ON for 1/2 of a second** (30 cycles).

To **INTERRUPT A repeat Sequence or STOP at the end of a weld**, find [**P.O.**] in the Extended Functions and program a value of [**P.O.**] = 14.

While in the constant current mode, the Control will measure the value of current maintained during the weld and show this value on DATA displays at the end of the sequence.

If a window is being monitored for HI/LO range, the value shown on the display will be the current maintained by the control, if the control can maintain this value. If the Control cannot maintain the set current value, **the control will DISPLAY LO or HI permanently**. In addition, **the control will stop a repeat sequence if in the repeat mode or stop the Control from any further initiations**. In order to re-enable initiations, it is necessary to simply press any front panel pushbutton to clear HI/LO error.

To obtain a **Weld current Readout without monitoring HI/LO LIMITS**, program Extended Functions parameter Process Output [**P.O.**] = 12. Program a value in the weld current parameters [**H.L.**] = 00.99, or [**H.L.**] = XX.XX, where XX.XX is close to the maximum available current. Program a value in the weld current parameters [**L.O.**] = 00.10. Do not leave these values at zero. If HI or LO are left at zero, the control uses a default window of current value+10% for the HI, and current value -10% for the LO, and monitors a default window as described above.

If any other **non-constant current Process Output** must be used, simply use the SELECT push-button to indicate Percent Current before weld initiation, as explained in previous section.

### 8.1.3 SETTING UP CURRENT REGULATOR ON EN1001 (for primary sensor, secondary Hall Effect sensor or secondary coil with Auto Range selection *only*)

The control must be initiated using a FS3 initiation switch **connected between TS1-FS3 and GND**. If the machine does not have permanent initiations using this terminal, temporarily connect a switch to FS3.

Make sample welds with Constant Current off, [C.r.] = 00, to determine the proper welding transformer tap switch setting. Percent current should be between 70% and 80% and weld time should be the recommended number of cycles for the material being welded.

**In order for the control to adapt to changing conditions, it must be able to adjust current. If weld is made around 75% the control can move up to 99% or down to 20% if necessary to maintain current constant when the control is in constant current mode.**

1. Put the Control in PROGRAM mode.

2. Select Extended Function [C.r.] and program 10, 20 or 30, depending on current sensing option.

3. Select Extended Function [r.R.] and program:  
00.99 for operating in [%] mode, or  
xx.xx for operating in [kA] mode (xx.xx is max RMS current in kA).

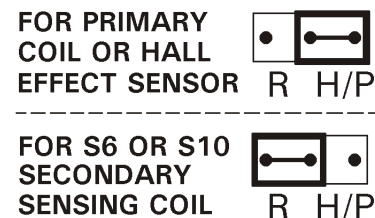
4. Select Extended Function [C.R.] Program **04** on the data display, and press ENTER. This presets schedules 90 to 97 with specific set-up parameters, including 30 cycles of squeeze time, 99 cycles of Squeeze Delay time, and Solenoid Valve 1 output. The control will remain in Program mode. The most important part here is that there is one schedule per contactor. For example, for 5 cascade control, a setup must be run on each of the 5 (SCRs /Welding transformer).

5. At this point, each of the 8 schedules can be modified for the application. Squeeze time may be changed and Valves may be changed to adapt to the application. Traditional Cascade applications normally use one valve for all contactors. Once the one valve closes all electrodes, contactors are fired in cascade. Do not change any parameters other than Squeeze time, or Valve mode. The setup must be run using the contactors as assigned.

**NOTE:** If necessary Squeeze Time, or valve output may be changed to match machine requirements. Switch to Program mode, change the Squeeze time, or Valve and press Enter. Return to Operate mode.

6. Delete the schedule following the last available SCR. In a 2 contactor cascade control, Schedule 92 (Corresponding to Contactor 3) must be deleted. In the PROGRAM Mode, Simply select SCHEDULE 92, Hold the ENTER push-button and click the PROGRAM /OPERATE push-button.

7. Select Extended Function [C.R.] Program **05** on the data display, and press ENTER. This prepares the control to run a setup on each of the available SCR/Welding Transformers. The control DATA display will flash [S.E.t.] to indicate setup is ready to run.



**Figure 8.1.1** Jumper Setting



8. Using the same material already welded\*\*, insert it between the machine electrodes as in step 2, initiate a weld sequence and hold the initiation switch **FS3** closed. The machine electrodes will close and the control will sequence through a pre-set test schedule. When Setup is complete, the control counts down on the display and returns to Schedule 00 and display [ 0- ], or [ -- ] on the data display.

**\*\* While in setup, the control makes multiple welds using 4 cycle pulses. If the part being welded can not support weld times of 4 cycles without expulsion or distortion the parameters measured may not provide correct setup data. In this case, run the setup with no material between the electrodes.**

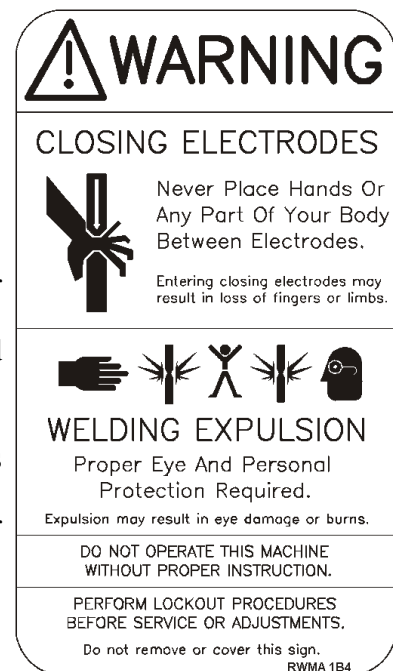
9. Release the initiation switch. The Control is now set-up and ready to operate. Sequence parameter CURRENT must be re-programmed now as a four digit number (example: 80% = 0080, or 15.7kA = 15.70). Return back to OPERATE Mode.

**NOTE:** Before running the setup, make sure that jumper on back side of the Control Board is set in proper position, as shown on Figure 8.1.1.

Schedules programmed in Constant Current mode require a percent current entered in a four digit Data Display. Since the Constant current operation depends on the contactor assigned to the given schedule, the percent current should be reasserted after programming the contactor. To insure correct operation, Select each cascade Weld Schedule, put the control in Program mode and press ENTER for each of the Percent Currents programmed to reassert this value after the contactor has been selected.

#### 8.1.4 QUICK SETUP SUMMARY

1. Put the Control in PROGRAM Mode.
2. Program [C.r.]=10.
3. Program [C.A.]=04.
4. Delete the first schedule following the last contactor (Controls with less than eight contactors).
5. Adjust Schedule to requirements (Valves, Outputs and Squeeze times).
6. Program [C.A.]=05.
7. Close FS3 and maintain initiation until control shows dash [ - ] signaling that setup is complete.
8. Reprogram Percent in each of the schedules used. For example [0055] - ENTER, etc.
9. Return Control to OPERATE Mode.



## 8.2 CONSTANT CURRENT OPERATION WITH PRIMARY SENSOR

The EN1001 Control in constant current mode with a primary Current Transformer as current sensor beside *percent* mode, allows two *kA* modes of operation: Range (Proportional) Mode and Ratio Mode. Choose and program one of the modes from the Table 5.4.14 or Table 5.4.15, as described in sections 5.4.14 and 5.4.15.



Figure 8.2.1 Primary Sensor - P5

### 8.2.1 RANGE OR PROPORTIONAL MODE

In this mode, a learning type setup is required. This mode should be used in percent mode with  $[r.R.] = 00.99$ , or *kA* mode with  $[r.R.]$  as maximum RMS secondary current entered at the end of setup procedure (in this case an external Weld Monitor may be used to measure maximum RMS current that could be entered as maximum range).

1. Put the control in PROGRAM Mode.
2. Click SELECT until the DATA display shows [ *EF* ].
3. Click the left SCHEDULE push-button until the SCHEDULE display shows [*L.r.*].
4. Use the DATA and ENTER push-buttons to program:  
[*L.r.*] = 10, for Regulation and Monitoring, or  
[*L.r.*] = 11, for Monitoring only.
5. Click the right SCHEDULE push-button until the SCHEDULE display shows [*r.R.*].
6. Use the DATA and ENTER push-buttons to program:  
[*r.R.*] = 00.99, for program and display current in [%], or  
[*r.R.*] = **xx.xx**, for program and display current in [*kA*].  
Where **xx.xx** is maximum RMS current, might be any number except 00.99.
7. Follow instructions from Section 8.1.3 for setting up current regulator.

After programming [*L.r.*] and [*r.R.*] Extended Functions parameters, Control is ready for Setup Procedure. After setup is done, parameter [*r.R.*], in *kA* mode, should hold approximately the maximum RMS current in [*kA*] for the used Transformer TAP. If Weld Monitor is available, exact maximum RMS current could be used for reprogramming parameter [*r.R.*]. To obtain maximum RMS measurement with Weld Monitor, put Control in non-constant current mode and make weld with 99%, if possible.

### 8.2.2 RATIO MODE

In this mode, setup is NOT required, since the Control is already calibrated in the Factory by using standard *calibration procedures* for the Gain Calibration on the Control Board. However, the welding transformer ratio must be programmed in order to use secondary current in [*kA*] and show measured current on the data displays. Also, the primary current sensor must be selected.

1. Put the control in PROGRAM Mode.
2. Click SELECT until the DATA display shows [ *EF* ].
3. Click the left SCHEDULE push-button until the SCHEDULE display shows [*L.r.*].
4. Use the DATA and ENTER Push-Buttons to program:  
[*L.r.*] = 12, 14, 16, or 18 for Regulation and Monitoring, or  
[*L.r.*] = 13, 15, 17, or 19 for Monitoring only, as shown in the Table 8.2.1.

5. Click the left SCHEDULE push-button until the SCHEDULE display shows [*r.R.*].
6. Use the DATA and ENTER push-buttons to program:  
 [*r.R.*] = **xxxx**, where  
**xxxx** is: welding transformer ratio  $rA_{WT} = U_P / U_S = I_{SECONDARY} / I_{PRIMARY}$  ;  
 or any number from 0001 to max 0435, 0174, 0087, or 0043 for PT2, PT5, PT10 or PT20, respectively.
7. Click the SELECT push-button and select CURRENT [%] or [kA].
8. Program the desired Current in [%] (monitoring mode) or in [kA] (compensation and monitoring mode) for the dialed Schedule.
9. Put the control back in the OPERATE Mode.

Table 8.2.1 *Constant Current Ratio Modes with Primary Sensor*

PT designation	Coil Ratio	RANGE	$rA_{WT MAX}$	[ <i>L.r.</i> ]	
				Compensation	Monitoring
PT2	200:5 A/A	200 A	0435	12	13
PT5	500:5 A/A	500 A	0174	14	15
PT10	1000:5 A/A	1000 A	0087	16	17
PT20	2000:5 A/A	2000 A	0043	18	19

All monitoring modes [*L.r.*] = 13, 15, 17, or 19 have following exceptions:

- CURRENT** - current in [%] from 0000 (0 %) to 0099 (99%);
- L.o.** - **Low** current limit window in [kA] from 00.00 (0 kA) to 99.99 (99.99 kA);
- H. i.** - **High** current limit window in [kA] from 00.00 (0 kA) to 99.99 (99.99 kA).

In these monitoring modes also, RMS in [kA] will be always shown on DATA display after end of the sequence, which may be useful for setting Hi/Low limit window.

**NOTE:** For [*r.R.*] = 0010, schedule parameter current will be programmed in “primary Amps” and Control will show on display primary current in [A]. This may be useful if welding transformer ratio is unknown.

### 8.2.3 SET POINT SETUP FOR PRIMARY COMPENSATION MODE

Since the setup is not required in **Ratio Mode** Control will use calibrated gain to operate and show current on the display. But, depends on size of the welding transformer, size of the primary current transformer and maximum operating range of the machine, Up-slope or overshooting during first several cycles of the weld could happen **only** in compensation mode. This may happen because Control does not know correlation between percent phase shift and measured current in kA before weld. In order to eliminate or minimize effect of Up-slope or overshooting during compensation, following simple set point setup procedure is recommended (but not required).

1. Put the control in PROGRAM Mode.
2. Program one of the monitoring modes [*L.r.*] = 13, 15, 17, or 19.
3. Program the desired Current in [%], 0060 for 60%, for the dialed Schedule, along with other schedule parameters like SQUEEZE, WELD or HOLD time.
4. Put the control back in the OPERATE Mode.

5. Before sequence initiation, select Percent Current using the SELECT push-button.
6. Make sample welds with chosen schedule to determine the proper welding transformer tap switch setting . Weld time should be the recommended number of cycles for the material being welded. Percent current should be high enough in order to achieve desired secondary current. After end of weld and releasing initiation switch, current in kA will be shown on DATA displays.
7. At this point press and hold ENTER push-button, on DATA displays [**5.E.t.R.**] message will appear. While ENTER is held, press SELECT push-button to store this **set point**, which represents correlation between phase shift percent and current in kA, in to EEPROM memory of the Control.
8. After this, the Control can be reprogrammed back to one of the corresponding compensation modes [**L.r.**] = 12, 14, 16, or 18.

### 8.3 CONSTANT CURRENT OPERATION WITH SECONDARY HALL EFFECT BASED CURRENT TRANSDUCER

The EN1001 Control in constant current mode with a Secondary Hall-Effect Transducer as current sensor beside *percent* mode, allows Range (Proportional) *kA* mode of operation. In both cases, setup procedure for auto gain selection is required as described in Section 8.1.3. Manual gain or range selection along with sensor positioning should be performed, as described in Section 8.3.2, if setup is not possible. Choose and program one of the modes from the Table 5.4.14 or Table 5.4.15, as described in sections 5.4.14 and 5.4.15.

#### 8.3.1 AUTO RANGE OR PROPORTIONAL MODE WITH SETUP

In this mode, a learning type setup is required. This mode should be used in percent mode with [**r.R.**]=00.99, or kA mode with [**r.R.**] as maximum RMS secondary current entered at the end of setup procedure.

1. Put the control in PROGRAM Mode.
2. Click SELECT until the DATA display shows [**EF**].
3. Click the left SCHEDULE push-button until the SCHEDULE display shows [**L.r.**].
4. Use the DATA and ENTER push-buttons to program:  
[**L.r.**] = 20, for Regulation and Monitoring, or  
[**L.r.**] = 21, for Monitoring only.
5. Click the right SCHEDULE push-button until the SCHEDULE display shows [**r.R.**].
6. Use the DATA and ENTER push-buttons to program:  
[**r.R.**] = 00.99, for program and display current in [%], or  
[**r.R.**] = **xx.xx**, for program and display current in [kA].

Where **xx.xx** is maximum RMS current, might be any number except 00.99.

7. Follow instructions from Section 8.1.3 for setting up current regulator.

After programming [**L.r.**] and [**r.R.**] Extended Functions parameters, Control is ready for Setup Procedure. After setup is done, parameter [**r.R.**], in *kA* mode, could be reprogrammed with exact value of maximum RMS current in [kA], if known, for the used Transformer TAP. To obtain maximum RMS measurement with Weld Monitor, put Control in non-constant current mode and make weld with 99%, if possible.



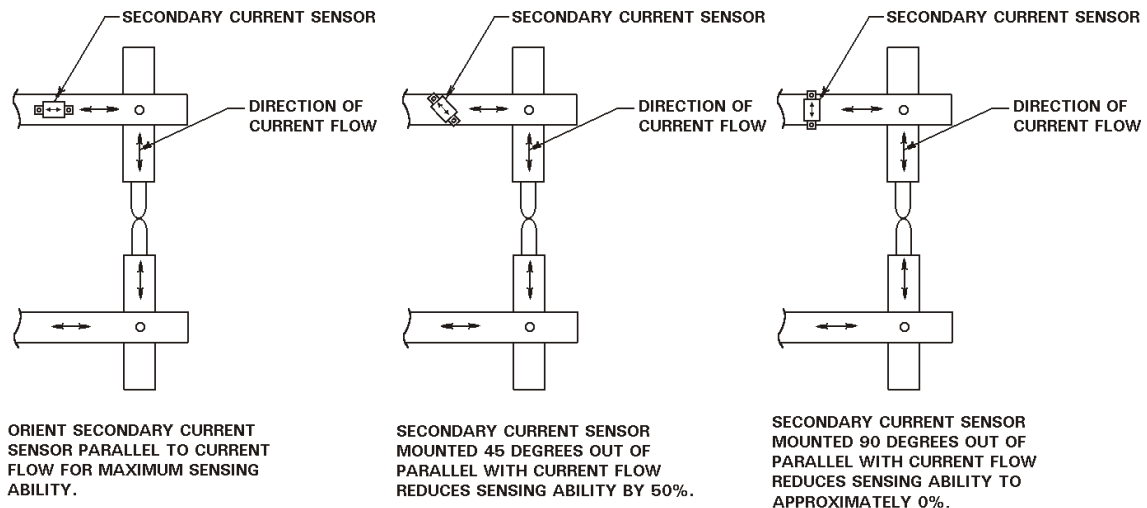
**Figure 8.3.1** Hall-Effect Sensor

### 8.3.2 MANUAL RANGE MODE WITHOUT SETUP

In case that setup procedure is **not** allowed due to some circumstances, a manual range selection is possible without running the setup. This is possible with combination of adjusting the relative position of the Hall effect Current Transducer and programming one of the manual ranges as described in Section 8.4.2.

The Control is already calibrated in the Factory by using standard *calibration procedures* for the Gain Calibration on the Control Board for total of 16 ranges. However, relative position of the Hall effect Sensor must be adjusted accordingly, as shown on Figure 8.3.2.

1. Put the control in PROGRAM Mode.
2. Click SELECT until the DATA display shows [ **EF** ].
3. Click the left SCHEDULE push-button until the SCHEDULE display shows [ **L.r.** ].
4. Use the DATA Push-Buttons to program:  
[ **L.r.** ] = 33, for Monitoring only.
5. Press ENTER.
6. Click the left SCHEDULE push-button until the SCHEDULE display shows [ **r.R.** ].
7. Use the DATA push-buttons to program:  
[ **r.R.** ] = **99.99**, for operate with maximum possible range.
8. Press ENTER.
9. Click the SELECT push-button and select CURRENT [%] or [kA].
10. Program the desired Weld Time and Weld Current in [%] for the dialed Schedule, for example 4 weld cycles and 50% current phase-shift.
11. Put the control back in the OPERATE Mode.
12. Place the Current Hall Effect Sensor, as shown on Figure 8.3.2, parallel to the current flow to allow maximum sensing ability.
13. Select CURRENT before closing initiation, make a weld, and read current on the DATA display after weld. Compare this reading to the Weld Scope or Weld Monitor reading. Reprogram [ **r.R.** ] to lower range if necessary, all 16 ranges are given in Table 8.4.1. For the same example of 50% phase-shift, if reading is 12.00 kA, then range can be reprogrammed to [ **r.R.** ] = **30.00**. If necessary, Current Sensor position might be adjusted also.
14. Repeat previous step as needed until satisfactory range and current reading is obtained.



**Figure 8.3.2** Secondary Hall Effect Sensor orientation

After choosing desired range and sensor positioning, if necessary program [C.r.] = 32 for Compensation (Regulation) and Monitoring. In this mode, Current can be programmed only in [kA].

Monitoring mode [C.r.] = 33 has following exceptions:

- CURRENT** - current is only in [%] from 0000 (0 %) to 0099 (99%);
- L.l.** - **Low** current limit window in [kA] from 00.00 (0 kA) to 99.99 (99.99 kA);
- H. l.** - **High** current limit window in [kA] from 00.00 (0 kA) to 99.99 (99.99 kA).

## 8.4 CONSTANT CURRENT OPERATION WITH ROGOWSKI COIL

The EN1001 Control in constant current mode with a secondary Rogowski Coil as current sensor, Figure 8.4.1, allows two modes of operation: Auto Range Selection, and Manual Range Selection. The simplest and quickest to use is manual range selection.

### 8.4.1 AUTO RANGE SELECTION

In this mode, a learning type setup is required, as described in Section 8.1.3. This mode should be used *only* when the secondary current range is not known. This is similar mode to constant current with primary sensing or secondary sensing with Hall Effect sensor.

1. Put the control in PROGRAM Mode.
2. Click SELECT until the DATA display shows [EF].
3. Click the left SCHEDULE push-button until the SCHEDULE display shows [C.r.].
4. Use the DATA and ENTER push-buttons to program:  
[C.r.] = 30, for Regulation and Monitoring, or  
[C.r.] = 31, for Monitoring only.
5. Click the left SCHEDULE push-button until the SCHEDULE display shows [r.R.].
6. Use the DATA and ENTER push-buttons to program:  
[r.R.] = 00.99, for program and display current in [%], or  
[r.R.] = xx.xx, for program and display current in [kA].  
Where xx.xx might be any number, except 00.99.
7. Follow instructions in Section 8.1.3 for setting up current regulator.



**Figure 8.4.1** Secondary Sensor - S6

After programming [C.r.] and [r.R.] Extended Functions parameters, Control is ready for Setup Procedure. This procedure is the same as setup procedure for EN1001 Controls with current transformer and Hall effect current sensors. The only difference is that after setup is performed in this way in [kA] mode, the parameter [r.R.] will hold approximately the maximum RMS current in [kA] for the used Transformer TAP.

After finishing setup, the Control is in Constant Current mode and ready to operate. Original value for Current Percent used in Non Constant Current mode is no longer available.

## 8.4.2 MANUAL RANGE SELECTION

In this mode, setup is NOT required, since the Control is already calibrated in the Factory by using two independent *calibration procedures* for the Control Board and for the Secondary Coil. However, the control must be programmed for the desired current range in which the machine will operate. In this mode Current is programmed and displayed only in [kA], except in monitoring mode [ $\mathcal{L}.r.$ ] = 33 .

1. Put the control in PROGRAM Mode.
2. Click SELECT until the DATA display shows [  $\mathcal{E}\mathcal{F}$  ].
3. Click the left SCHEDULE push-button until the SCHEDULE display shows [ $\mathcal{L}.r.$ ].
4. Use the DATA Push-Buttons to program:  
 $\mathcal{L}.r.$  = 32, for Regulation and Monitoring, or  
 $\mathcal{L}.r.$  = 33, for Monitoring only.
5. Press ENTER.
6. Click the left SCHEDULE push-button until the SCHEDULE display shows [ $r.R.$ ].
7. Use the DATA push-buttons to program:  
 $r.R.$  =  $xx.xx$ , for operate in desired range.

Where  $xx.xx$  must correspond to desired range, as shown in the Table 8.4.1.

Table 8.4.1 *Operating Ranges for Manual Range Selection with Rogowski Coil*

Current Range in kA	Range Parameter [ $r.R.$ ]	Current Range in kA	Range Parameter [ $r.R.$ ]
0 ÷ 2	02.00	0 ÷ 30	30.00
0 ÷ 3	03.00	0 ÷ 40	40.00
0 ÷ 4	04.00	0 ÷ 50	50.00
0 ÷ 5	05.00	0 ÷ 60	60.00
0 ÷ 6	06.00	0 ÷ 70	70.00
0 ÷ 8	08.00	0 ÷ 80	80.00
0 ÷ 10	10.00	0 ÷ 90	90.00
0 ÷ 20	20.00	0 ÷ 100	99.99

8. Press ENTER.
9. Click the SELECT push-button and select CURRENT [%] or [kA].
10. Program the desired Current in [kA] for the dialed Schedule.
11. Press ENTER.
12. Put the control back in the OPERATE Mode.

The weld control will sequence and fire the SCRs according to the Operating Range defined with [ $r.R.$ ].

**NOTE:** [ $\mathcal{L}.r.$ ] must be equal 32 or 33, before changing the Operating Range.

Monitoring mode [ $\mathcal{L}.r.$ ] = 33 has following exceptions:

- CURRENT** - current in [%] from 0000 (0 %) to 0099 (99%);
- L. o.** - **Low** current limit window in [kA] from 00.00 (0 kA) to 99.99 (99.99 kA);
- H. i.** - **High** current limit window in [kA] from 00.00 (0 kA) to 99.99 (99.99 kA).

In this mode also, RMS in [kA] will be shown on DATA display after end of the sequence, which may be useful for setting Hi/Low limit window.

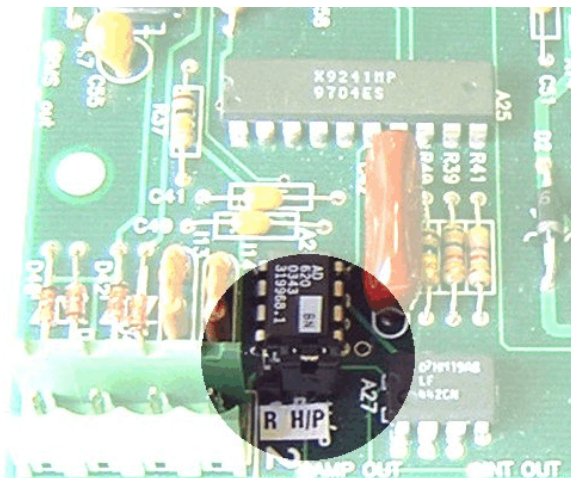
### 8.4.3 CHOOSING A RANGE

The desired range should be as close as possible to the maximum operating range of the welding machine. If the programmed range is far below or far above operating range, after any weld the RMS current may be far above or far below desired RMS values, or with [P.O.] = 12 the Control will display Error HI or LO. In such cases, the range has to be changed by programming lower or higher [r.A.], otherwise the Transformer TAP has to be moved up or down, if that is possible.

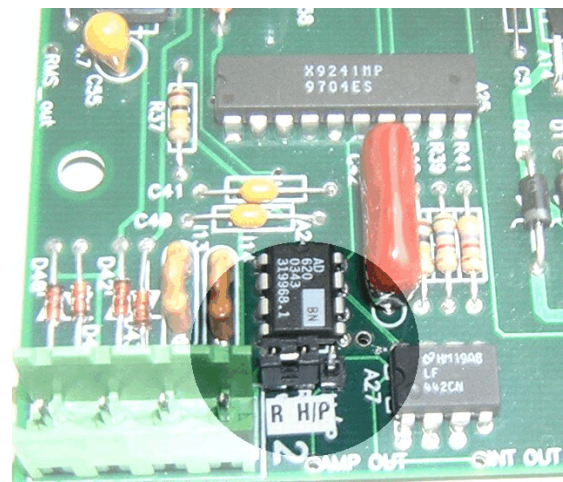
If the operating range of the welding machine is unknown, running the setup procedure is recommended. After running the setup for [C.r.] = 30, and [r.A.] is any value except 00.99, approximately the maximum RMS value will be stored in [r.A.]. Once that value has been determined for the TAP setting necessary for a good weld, go to the table on previous page and determine the range parameter [r.A.] closest to the value determined by the setup and use that value when reprogramming [r.A.] in the manual range mode with [C.r.] = 32 or 33.

## 8.5 SENSOR SELECTION JUMPER SETTINGS

Proper jumper settings for different type of the sensors is shown on Figure 8.5.1 for Primary Sensor or Hall-Effect Sensor, and Figure 8.5.2 for Secondary Rogowski Coil.



**Figure 8.5.1** Jumper setting:  
Primary Sensor or Hall-Effect Sensor  
(two pins on the right)



**Figure 8.5.2** Jumper setting:  
Secondary Sensor - Rogowski Coil  
(two pins on the left)



## 9. APPLICATIONS AND PROGRAMMING EXAMPLES

The EN1000/EN1001 Series Control could be programmed for numerous welding applications, but only few of them are highlighted here.

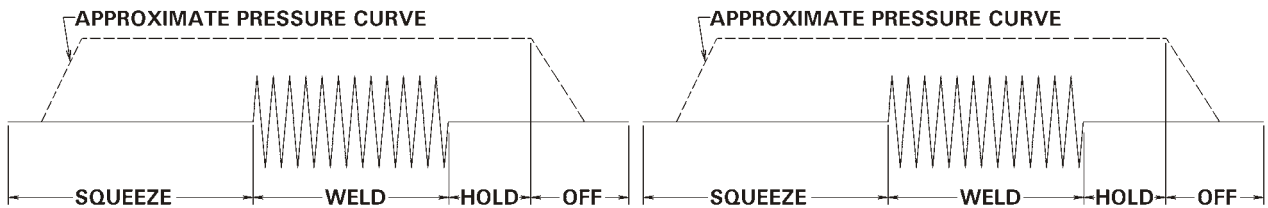
The schedules shown are for demonstration purposes. In order to easily follow visually the schedules as they progress, the individual "times" in each one have been made longer than they would be for an actual machine operation.

### 9.1 SPOT MODE EXAMPLES

#### 9.1.1 SPOT - REPEAT MODE

Schedule **00** is a spot schedule in the repeat mode. Momentary initiation results in one sequence only. If the initiation is held closed, the sequence will continue repeating. Valve output #2 is used.

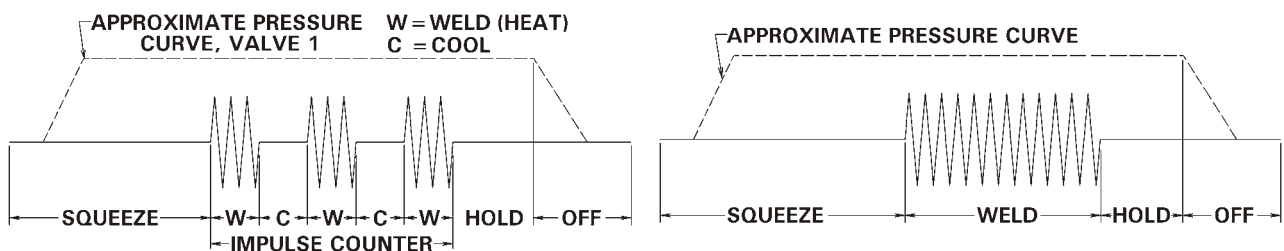
SCHEDULE	SQUEEZE	WELD/HEAT	PERCENT CURRENT	HOLD	OFF	IMPULSES	COOL	VALVE MODE	CYCLE MODE	SLOPE MODE	SLOPE COUNT
00	40	30	60	10	15	01	00	02	01	00	00



#### 9.1.2 PULSATION AND SUCCESSIVE MODE

Schedule **00** and **01** are pulsation and spot schedules combined in the successive mode. Schedule 01 is initiated first. When it is completed, schedule 02 will flash to indicate that it is ready to be initiated. After it is completed, the schedule display will return to 01. Schedule 01 uses valve #1, schedule 02 uses valve #2.

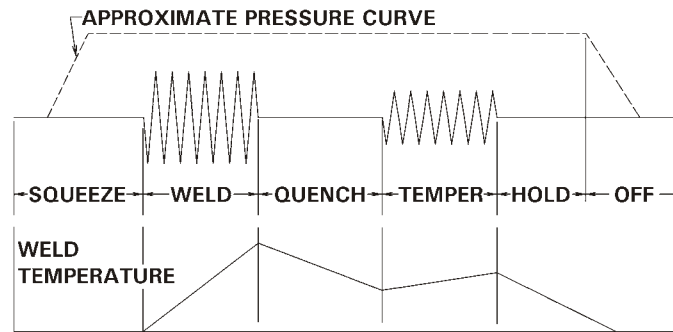
SCHEDULE	SQUEEZE	WELD/HEAT	PERCENT CURRENT	HOLD	OFF	IMPULSES	COOL	VALVE MODE	CYCLE MODE	SLOPE MODE	SLOPE COUNT
01	20	10	60	10	10	03	06	01	03	00	00
02	25	30	60	10	10	01	00	02	00	00	00



### 9.1.3 QUENCH TEMPER WITH CHAIN MODE

Schedules 03 and 04 are chained together to illustrate "Quench-Temper" operation. Schedule 03 performs the squeeze, weld and quench functions (using "Hold" for Quench), and 04 performs the temper and hold functions (using "Weld" for Temper). Valve output #3 is used. The weld light gives a visual indication of the relative amplitude and duration of current during weld and temper times.

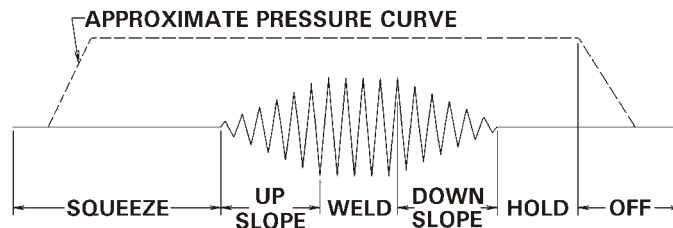
SCHEDULE	SQUEEZE	WELD/HEAT	PERCENT CURRENT	HOLD	OFF	IMPULSES	COOL	VALVE MODE	CYCLE MODE	SLOPE MODE	SLOPE COUNT
03	40	35	60	35	10	01	00	04	02	00	00
04	00	30	40	20	10	01	00	04	00	00	00



### 9.1.4 UP AND DOWN SLOPE WITH CHAIN MODE

Schedules 05, 06, 07 and 08 are chained together to illustrate up-down slope operation. Schedule 05 performs the squeeze function and establishes the percent current at which the up slope will begin (bottom current). Schedule 06 performs the weld function and sets the up slope time. Schedule 07 sets the downslope time and the % current it starts from. Schedule 08 establishes the percent current at which the downslope will end, and performs the hold function. The number in the schedule display will change as the sequence progresses from one schedule to the next. Valve output #1 is used for this example.

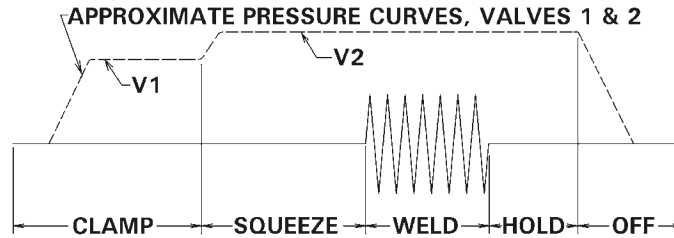
SCHEDULE	SQUEEZE	WELD/HEAT	PERCENT CURRENT	HOLD	OFF	IMPULSES	COOL	VALVE MODE	CYCLE MODE	SLOPE MODE	SLOPE COUNT
05	40	00	10	00	00	01	00	01	02	00	00
06	00	20	60	00	00	01	00	01	02	01	20
07	00	00	60	00	00	01	00	01	02	02	22
08	00	00	05	20	10	01	00	01	00	00	00



### 9.1.5 BUTT WELD WITH CHAIN MODE

Schedules 11 and 12 are chained together to perform a butt welding sequence. Schedule 11 contains only "Squeeze" timing with valve #1 output, and is used as the clamp function. Schedule 12 follows the clamp function with a normal squeeze, weld, hold sequence with valve #2 output. Both valve outputs turn off at the end of hold time.

SCHEDULE	SQUEEZE	WELD/ HEAT	PERCENT CURRENT	HOLD	OFF	IMPULSES	COOL	VALVE MODE	CYCLE MODE	SLOPE MODE	SLOPE COUNT
11	20	00	00	00	00	01	00	01	02	00	00
12	20	10	50	10	10	01	00	03	00	00	00



### 9.1.6 FORGE DELAY WITH CHAIN MODE

The forging process is most often used when working with "hard to weld" materials such as aluminum. The weld is usually started at one force, followed by the application of a higher force during weld or hold time. This action may refine the weld zone, and provide a more homogeneous weld nugget.

Timing of the application of forging force is critical. If applied too soon, the welding current may be insufficient for the higher force. If applied too late, the weld will have solidified and the forging force will do no good.

Forge delay is defined as the delay from the beginning of the weld to the activation of the forging solenoid valve. To accomplish a FORGE DELAY operation on EN1000/EN1001 series controls, it is necessary to chain together 2 or more SCHEDULES as outlined below.

1. Program the first SCHEDULE with the amount of WELD time desired before the activation of the forging valve. Use any one of the 3 solenoid valve outputs.
2. For FORGE during weld, program the second SCHEDULE with remaining WELD time and program an unused solenoid valve output. This second valve output activates the forging valve.

**NOTE:** For continuous current from the first SCHEDULE to the second schedule, do not program any HOLD time into the first SCHEDULE or SQUEEZE time into the second SCHEDULE.

3. For Forge after weld, program the number of cycles of time between WELD time and the activation of the FORGE valve into HOLD time of the first SCHEDULE or into SQUEEZE time of the second SCHEDULE.

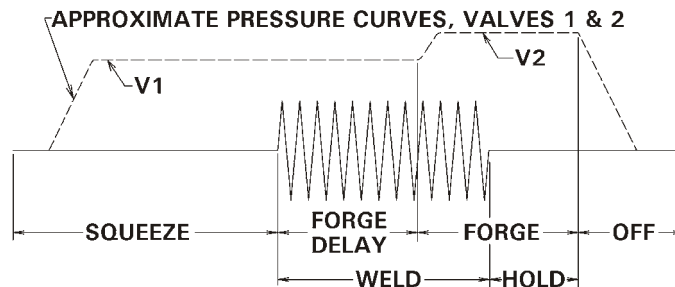
SCHEDULE	SQUEEZE	WELD/ HEAT	PERCENT CURRENT	HOLD	OFF	IMPULSES	COOL	VALVE MODE	CYCLE MODE	SLOPE MODE	SLOPE COUNT
00	xx	xx	xx	00	00	01	00	02	02	00	00
01	00	xx	xx	xx	00	01	00	06	00	00	00

### SCHEDULE 00

SQUEEZE count                      desired SQUEEZE count  
 WELD /HEAT count                desired WELD count before forging takes place  
 PERCENT CURRENT                desired PERCENT CURRENT for WELD  
 HOLD count                        00 cycles (cycles after weld before forge)  
 VALVE MODE                        02 (Valve #2)  
 CYCLE MODE                        02 (chained mode)

### SCHEDULE 01

SQUEEZE count                      00 cycles  
 WELD /HEAT count                desired WELD count after forging takes place  
 PERCENT CURRENT                desired % CURRENT for WELD during forge  
 HOLD count                        desired HOLD count  
 VALVE MODE                        06 (Valve #2 and Valve #3)  
 CYCLE MODE                        00 (single spot mode)



In the next example, solenoid valve 1 will be the standard valve and solenoid valve 2 will be the forging valve. The total weld time is 15 cycles at 95 percent current with the forging valve activated after 10 cycles.

SCHEDULE	SQUEEZE	WELD/HEAT	PERCENT CURRENT	HOLD	OFF	IMPULSES	COOL	VALVE MODE	CYCLE MODE	SLOPE MODE	SLOPE COUNT
00	20	10	95	00	00	01	00	01	02	00	00
01	00	05	95	20	00	01	00	03	00	00	00

### SCHEDULE 00

SQUEEZE count                      20 cycles  
 WELD /HEAT count                10 cycles  
 PERCENT CURRENT                95 %  
 HOLD count                        00 cycles  
 OFF count                        00 cycles  
 IMPULSES                        01 (no impulses)  
 COOL count                        00 cycles  
 VALVE MODE                        01 (Valve #1)  
 CYCLE MODE                        02 (chained)  
 SLOPE MODE                        00 (no slope)  
 SLOPE count                        00 cycles

### SCHEDULE 01

SQUEEZE count                      00 cycles  
 WELD /HEAT count                05 cycles  
 PERCENT CURRENT                95 %  
 HOLD count                        20 cycles  
 OFF count                        00 cycles  
 IMPULSES                        01 (no impulses)  
 COOL count                        00 cycles  
 VALVE MODE                        03 (Valve #1, #2)  
 CYCLE MODE                        00 (non repeat)  
 SLOPE MODE                        00 (no slope)  
 SLOPE count                        00 cycles

For Forge during weld it is possible to select a percent current for the second schedule different from that of the first schedule.

Other combinations of weld schedules may be combined to create other FORGING schedules. For example it would be possible to use UP SLOPE in the first sequence and Pulsation in the second sequence.

## 9.2 SEAM MODE EXAMPLES

By definition Cascade Controls are not designed for seam mode applications, but after adding Cycle Mode 05 or Wait-here mode in firmware revision 619044-002C some type of seam mode is possible (for FS3 initiation only) even on these controls.

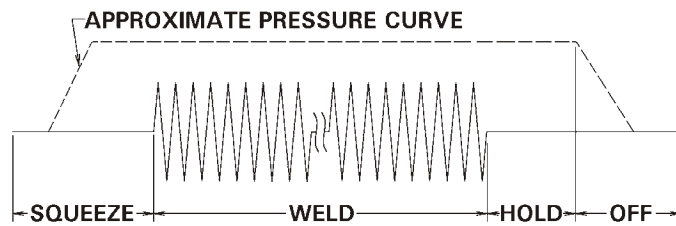
Seam mode of operation is possible by using Wait-here mode or Cycle mode 05. The control is enabled for this mode only by programming the [b.£.] extended function to 05. After this, Cycle mode must be programmed to 05 and Impulses to 99. Welding sequence must be initiated with FS3 initiation input, and after SQUEEZE time the Control will start to weld. In order to stop or break welding part of the sequence, either ES1 or WFS1/AUX1 must be activated or initiation inputs FS7 or FS11 will continue to execute sequence beginning with schedule 20 or 40, respectively.

**NOTE:** For more information about WAIT-HERE Cycle mode 05, refer to Section 6.2.6.

### 9.2.1 CONTINUOUS SEAM MODE WITH CYCLE MODE 05

Schedule **13** is a Wait-here mode, i.e. Cycle Mode is 05. To disable this mode in dialed schedule, reprogram the CYCLE MODE to any other values from 00 to 04 or change number of impulses.

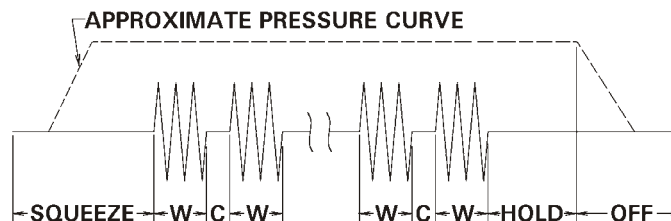
SCHEDULE	SQUEEZE	WELD/HEAT	PERCENT CURRENT	HOLD	OFF	IMPULSES	COOL	VALVE MODE	CYCLE MODE	SLOPE MODE	SLOPE COUNT
<b>13</b>	30	10	40	10	10	<b>99</b>	00	01	<b>05</b>	00	00



### 9.2.2 INTERMITTENT SEAM MODE WITH CYCLE MODE 05

Schedule **14** is an intermittent seam mode. Intermittent operation is accomplished by programming a value, other than 00, for COOL into the schedule. To disable this mode in dialed schedule, reprogram the CYCLE MODE to any other values from 00 to 04 or change number of impulses.

SCHEDULE	SQUEEZE	WELD/HEAT	PERCENT CURRENT	HOLD	OFF	IMPULSES	COOL	VALVE MODE	CYCLE MODE	SLOPE MODE	SLOPE COUNT
<b>14</b>	10	20	50	10	10	<b>99</b>	08	01	<b>05</b>	00	00



### 9.3 BRAZING APPLICATION

Brazing operations differ from Spot welding operations in that a much longer heating time may be required. This is because a much larger area must be raised to the melting temperature of the brazing material. Depending on the mass of the parts to be brazed, this time may vary from several cycles to several seconds.

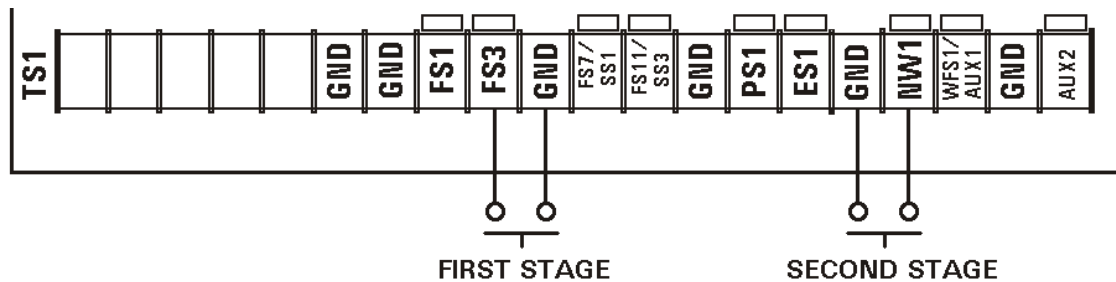
The EN1000 series of controls can be operated in two brazing modes; automatic, for short brazing times, and manual, most useful for long brazing times.

For the AUTOMATIC brazing mode, the EN1000 is initiated in the same manner as for spot welding. However, it must be programmed through the extended functions for "Beat initiation during squeeze and weld", in accordance with instructions in the manual. For convenience, these instructions are repeated here.

**NOTE:** To program the control to BEAT INITIATION DURING SQUEEZE and WELD, the EXTENDED FUNCTION [b.É.] Mode must be selected. See section 5.4.8. Use the SCHEDULE SELECT Push Buttons (20 & 21) and SCHEDULE Display (22) to select [b.É.]. With the control in the PROGRAM Mode enter a 02 into the DATA Display (4) using DATA Push Buttons (5 & 6). As typical of other data entry the ENTER Push Button (29) must be depressed to load the desired data.

In this mode, the initiation must be held closed for the time required to bring the parts to the required brazing temperature. If this time is longer than 99 cycles, two or more schedules must be chained together. If the operator then opens the initiation, the brazing current turns off immediately and the sequence advances to hold time, and after hold time the electrodes retract. The control will terminate the weld sequence normally at the end of the programmed schedule if the initiation Switch remains closed.

For the MANUAL brazing mode, "Beat initiation during squeeze and weld" is also programmed as above. In addition, set WELD/HEAT and IMPULSES to 99, PERCENT CURRENT and VALVE MODE in accordance with job requirements, and all other parameters to 00. Initiation switches are connected to the TS1 as shown on Figure 9.3.1.



**Figure 9.3.1** Using two stage initiation in Brazing Mode

In this mode, the operation is as follows: When the first stage is closed, the brazing electrodes close on the work. When the second stage is closed, brazing current comes on. If the second stage is opened, brazing current stops, but the electrodes stay closed. Current may be turned on and off in this manner as many times as desired by the operator. When the first stage is opened, the electrodes retract.

## 9.4 SQUEEZE DELAY APPLICATION

Some applications require the welder arms be opened wide to allow the electrodes to access areas to be welded. Squeeze Delay was designed for use with welding guns and stationary machines incorporating standard air cylinders and valves without retraction features. The additional time provided by the Squeeze Delay will allow the electrodes to travel a greater distance and simulate the retraction function. Squeeze Delay is only active in the first Schedule in a Repeat Sequence.

### 9.4.1 SQUEEZE DELAY OPERATION

Setting the control for Squeeze Delay will provide additional time before the programmed "Squeeze time" in all schedules. The Squeeze LED indicator on the control panel will dim slightly during the programmed Squeeze Delay time. Squeeze Delay time occurs only during the first "Squeeze" of a series of repeated welding sequences (Repeat Mode).

Squeeze Delay will be present in all schedules even if no other data has been entered.

Squeeze Delay is not intended for use with Seam or Anti-Tie Down modes of operation. If not required set [5.d.] to [00].

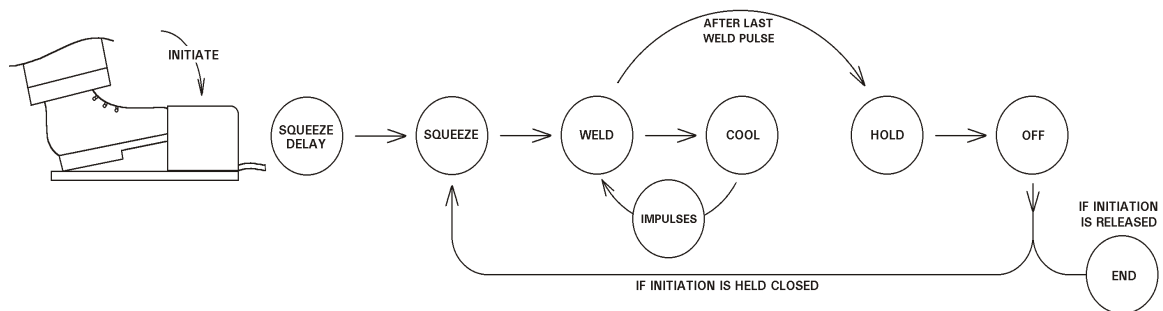


Figure 9.4.1 Squeeze delay operation

### 9.4.2 SQUEEZE DELAY PROGRAMING

1. Press the SELECT push button repeatedly until the Function indicator has advanced past SLOPE COUNT to enter data in the EXTENDED FUNCTIONS [EF].
2. Move through the EXTENDED FUNCTIONS until [5.d.] appears in the DATA Display.
3. Press the PROGRAM/OPERATE push button to place the control in the PROGRAM mode.
4. Press the DATA push buttons until the desired Squeeze Delay time, in cycles, is displayed.
5. Press the ENTER push button to store the desired data.
6. Select and enter Cycle Mode [01] (Repeat).
7. Adjust SQUEEZE and OFF time to allow the electrodes to open only a short distance between repeated welding sequences.
8. Press the PROGRAM/OPERATE push button to put the control in the Operate Mode.

## 9.5 RETRACTION APPLICATION

Retraction is used for welding guns and stationary machines with cylinders and valves configured for retraction operation. Retraction can be accomplished by de-energizing a valve solenoid allowing the electrode arms to separate, further than normal, to allow large parts to be placed between welding electrodes.

The Retraction valve can be activated by a momentary, [P.O.]=[08], switch closure that toggles the electrodes between the Retracted and non Retracted state or a maintained, [b.5.]=[09], closure. Air over Oil Retraction, [P.O.]=[07], is used on welding guns and stationary welders that incorporate special air over oil cylinders

### 9.5.1 RETRACTION OPERATION - MOMENTARY CLOSURE - [P.O.]=[08]

While the RETRACTION process output is enabled, the WFS1/AUX1 terminal is configured as a RETRACTION input. The Temperature Limit Switch normally connected to terminal WFS1/AUX1 should be moved to WFS1/NW1. A momentary closure of WFS1/AUX1 to GND will toggle the valve from the “on” to the “off” state these contacts are normally tied to a momentary type switch that is independent from the initiation switch. When the valve is “off” and the gun is in a fully retracted state the control can not initiate a weld sequence and an error [E.r.]=[27] message will appear on the display if initiation is attempted. Only when the valve is on and the electrodes are in the pre weld or extended position will the initiations be enabled.

The PO valve output between TS10-SV17 and TS10-SV18 is enabled by toggling the WFS1/AUX1 to GND switch. Valve Output on SV17 - SV18 remains on during and after a weld as long as the switch is not activated.

Successive schedules can be used with Retraction ([P.O.]=[08]).

When the RETRACTION valve is on, the control may not be placed into the Program mode. The TS1-WFS1/AUX1 (RETRACTION input) must be momentarily activated.

If the WFS1/AUX1 input switch is held CLOSED for a long period of time, error message [E.r.]=[06] will be displayed, but the error condition is abandoned and the valve output WILL BE TOGGLED upon the opening of TS1-WFS1/AUX1 from GND. The dial plate indication of the third valve output (RETRACTION VALVE) will not indicate the status of Process Output.

### **WARNING**

**Process Output Valve terminals are on Terminal Strip TS10 on A/N 410322 board.**

**For this Valve, the Valve Control Relay, which normally prevents valve activation until a weld sequence is initiated, is bypassed. Since this valve may now be activated without energizing the control relay, care MUST be taken to insure safe operation.**



## PROGRAMMING RETRACTION [*P.O.*]=[08]

1. Provide a constant closure of WFS1/AUX1 to GND
2. Press the SELECT push button repeatedly until the Function indicator has advanced past SLOPE COUNT to enter data in the EXTENDED FUNCTIONS [*EF*].
3. Scroll through the EXTENDED FUNCTIONS until [*P.O.*] appears in the SCHEDULE Display.
4. Press the PROGRAM/OPERATE push button to place the control in the PROGRAM mode.
5. Use the Data Push Buttons to display [08] in DATA Display.
6. Press the ENTER push button to store the data.
7. Open the Retraction switch “held closed” in Step 1.
8. Press the Program/Operate push button to put the control in the Operate Mode.

### 9.5.2 RETRACTION OPERATION - MAINTAINED CLOSURE - [*b.5.*]=[09] (THREE STAGE FOOT-SWITCH RETRACTION ADDITION)

EN1000/EN1001 Series Controls incorporating ROM #619016-002 Revision “R” or later will have the following Retraction Feature added.

If [*b.5.*] is set to [09] the control will now enter this new Retraction Mode. This Retraction implementation is different from [*P.O.*]=07 or [*P.O.*]=08 in that it uses one foot switch that has a maintained/latched contact that the control uses to turn on the Retraction Output V3. The software has a power-on interlock of the V3 output to block the V3 from turning on with power on. This new feature, simple as its operation may be, will help users implement this type of retraction without putting high voltage on one pole and/or in the same conduit as the low voltage foot switch wiring.

The valve output between TS10-SV17 and TS10-SV18 is enabled by closing the WFS1/AUX1 to GND switch. Valve Output on SV17 - SV18 remains on during and after a weld as long as the switch remains closed.

Successive schedules can be used with Retraction.

When the RETRACTION valve is on, the control may not be placed into the Program mode.

The dial plate indication of the third valve output (RETRACTION VALVE) will not indicate the status of Process Output.

#### **WARNING**

**Process Output Valve terminals are on Terminal Strip TS10 on A/N 410322 board.**

**For this Valve, the Valve Control Relay, which normally prevents valve activation until a weld sequence is initiated, is bypassed. Since this valve may now be activated without energizing the control relay, care MUST be taken to insure safe operation.**

## PROGRAMMING RETRACTION [b.5.]=[09]

1. Provide a constant closure of WFS1/AUX1 to GND
2. Press the SELECT push button repeatedly until the Function indicator has advanced past SLOPE COUNT to enter data in the EXTENDED FUNCTIONS [EF].
3. Scroll through the EXTENDED FUNCTIONS until [b.E.] appears in the SCHEDULE Display.
4. Press the PROGRAM/OPERATE push button to place the control in the PROGRAM mode.
5. Use the Data Push Buttons to display [09] in DATA Display.
6. Press the ENTER push button to store the data.
7. Open the Retraction switch “held closed” in Step 1.
8. Press the Program/Operate push button to put the control in the Operate Mode.

### 9.5.3 AIR OVER OIL RETRACTION OPERATION - [P.O.]=[07]

Air over Oil Retraction is used on welding guns and stationary welders that incorporate special air over oil cylinders.

This system requires the use of three solenoid valve outputs. The first output (Valve 1) is assigned to the EXTEND solenoid. When the control is initiated the EXTEND valve is turned on, and the electrodes will approach the work under low pressure. The INTENSIFY valve (Valve 2) is then turned on once the electrodes reach the work and welding pressure is applied. The control continues on to Weld time and Hold time. At the end of Hold time both the EXTEND and INTENSIFY valves are shut off and a BLOCKING delay timer is then started. At the end of BLOCKING delay the BLOCKING valve (PO Valve) is turned on. This valve is connected to the EXTEND port of the cylinder and when energized or closed, the return stroke can be halted before the gun completely opens. Initiating the EXTEND valve will de-energize the blocking valve solenoid.

Air Over Oil Retraction is available through the Extended Function, [P.O.]=[07].

Because of the longer time that is required for the electrodes to go from the fully retracted state to the closed state a SQUEEZE DELAY time is necessary. The SQUEEZE DELAY time is in addition to any scheduled Squeeze time. The control will only go through SQUEEZE DELAY when initiated from a fully retracted state. If the control is initiated when the blocking valve is on, the control will not go through SQUEEZE DELAY.

**NOTE:** The timing of [5.d.] (Step 2) and Advance OFF (Step 3) is counted in ½ cycle increments in order to double adjustment resolution.

### RETRACTION TOGGLE

When the control is programmed for Air over Oil retraction, FS1 can be used as an input to ADVANCE/RETRACT the gun. When extending, the gun will ADVANCE during the programmed Squeeze Delay time( using Valve 1). Valve 1 will de-energize and Advance Stop will begin. PO Valve will turn on immediately after the programmed Advance Stop time (Programmed Off time on Schedule 00 of our example ).

These steps assume that a blocking valve is connected to SV17-SV18( PO Valve Output).

1. Connect a normally open momentary close type switch between FS1 and GND.
2. Program Squeeze Delay to time the Advance of the gun to a ready position.
3. Program an Off time in the first of the two schedules composing the weld sequence. This Off time is designated as ADVANCE STOP time. This time will only occur during the FS1 toggle activation. It will not affect an actual weld sequence, since the first schedule is a non-welding part of the sequence.

To ADVANCE the electrodes, a momentary closure of FS1 will energize Valve 1.

The Blocking valve will turn on immediately at the end of a programmed ADVANCE STOP time. Travel distance will depend on Squeeze Delay plus Advance Stop. In addition, inertia of the gun, oil pressure, etc may influence travel distance.

While the blocking valve is energized, the front panel will indicate this status by blinking the PO Valve LED. In this state, the control does not allow programming changes.

To return the electrodes to a fully retracted state, a momentary closure of FS1 will de-energize PO Valve. The Emergency Stop input may also be used to retract the electrodes. The PO Valve output will remain off after the emergency stop is activated.

### **WARNING**

**Process Output Valve terminals are on Terminal Strip TS10 on A/N 410322 board.**

**For this Valve, the Valve Control Relay, which normally prevents valve activation until a weld sequence is initiated, is bypassed. Since this valve may now be activated without energizing the control relay, care MUST be taken to insure safe operation.**

In repeat sequences when programmed OFF time is SHORTER than or EQUAL to BLOCKING time, only BLOCKING delay time takes place. When OFF time is greater than BLOCKING time, the BLOCKING valve will turn on at the end of BLOCKING delay time and the control will continue through an Off time that is equal to OFF time minus BLOCKING time.

When the control is in sequence and is in SQUEEZE delay or in BLOCKING delay time periods, the Squeeze and Off LED indicators (respectively) will dim to ½ their intensity while the control continues through these times.

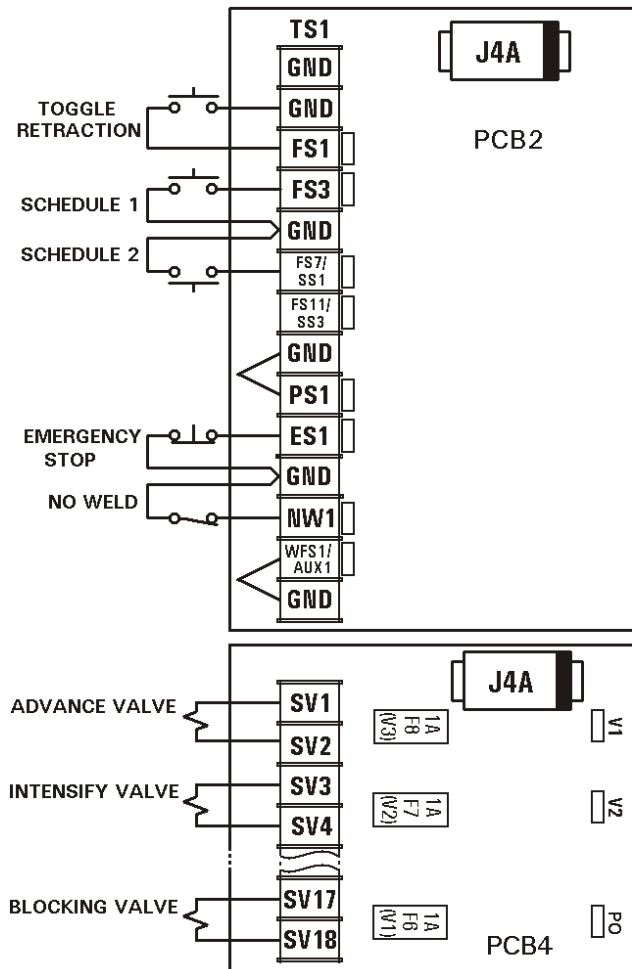
When [**P.O.**]=[**07**] is enabled, SQUEEZE delay time and BLOCKING delay time are in place for all 100 schedules.

Successive schedules can be used with [**P.O.**]=[**07**].

Extended Function Beat During Squeeze by definition will not work well with Process Output [**07**] as the electrodes will completely open and the BLOCKING valve will not turn on.

## PROGRAMMING AIR OVER OIL RETRACTION [*P.O.*]=[07]

1. Press the SELECT push button repeatedly until the Function indicator has advanced past SLOPE COUNT to enter data in the EXTENDED FUNCTIONS [*EF*].
2. Scroll through the EXTENDED FUNCTIONS until [*P.O.*] appears in the SCHEDULE Display.
3. Press the PROGRAM/OPERATE push button to place the control in the PROGRAM mode.
4. Use the Data Push Buttons to display [07] in DATA Display.
5. Press the ENTER push button to store the data. Scroll through the EXTENDED FUNCTIONS until [*5.d.*] appears in the SCHEDULE Display.
6. Press the DATA push buttons until the desired Squeeze Delay time is displayed in the SCHEDULE Display. (Time = Number of cycles).
7. Press the ENTER push button to store the data.
8. Press the SCHEDULE buttons to advance the schedule display to [*b.L.*] (BLOCKING DELAY).
9. Press the DATA push buttons until the desired BLOCKING DELAY TIME appears in the DATA display.



**Figure 9.5.1** Typical connections for Air over Oil

**NOTE:** Extended Function [*b.L.*] can only be accessed when [*P.O.*]=[07] is programmed.

10. Press the ENTER push button to store the data.
11. Using the examples below, enter chained schedules that will control the EXTEND AND INTENSIFY valve sequencing.

**Note:** Schedule 00 uses Valve 1 to activate the EXTEND valve for twenty cycles.

### SCHEDULE 00

SQUEEZE count (EXTEND)	20 cycles
WELD /HEAT count	10 cycles
PERCENT CURRENT	00 %
HOLD count	00 cycles
OFF count	05 cycles
IMPULSES	01 (no impulses)
COOL count	00 cycles
VALVE MODE	01 (Valve #1)
CYCLE MODE	02 (chained)
SLOPE MODE	00 (no slope)
SLOPE count	00 cycles

### SCHEDULE 01

SQUEEZE count (INTENSIFY)	10 cycles
WELD /HEAT count	15 cycles
PERCENT CURRENT	85 %
HOLD count	10 cycles
OFF count	00 cycles
IMPULSES	01 (no impulses)
COOL count	00 cycles
VALVE MODE	03 (Valve #1, #2)
CYCLE MODE	00 (non repeat)
SLOPE MODE	00 (no slope)
SLOPE count	00 cycles

## TIMING CHART ANALYSIS

Detailed sequencing of the cylinder can be better understood by studying sequence time charts discussed in sections as follows:

### SECTION A

Section A details a basic sequence and how it may begin. The blocking valve may be on or off and will be cleared by an Emergency Stop. FS3 is then initiated and Schedule 00 is started.

Since the BLOCKING valve is off, the sequence begins with Extended function [5.d.] SQUEEZE DELAY (if programmed) and then proceeds into Squeeze time (EXTEND). A valve mode of 01 is selected to turn on valve 1 only. Schedule 00 is Chained to Schedule 01. Schedule 01 begins and enters into Squeeze time (INTENSIFY), Weld time, and Hold time, A valve mode of 03 is selected to enable both valve 1 (EXTEND) and valve 2 (INTENSIFY). After Hold time is complete, the delay (if programmed) before blocking begins. When this delay is complete, valve three (BLOCKING) turns on. The control then waits for the next initiation, leaving the blocking valve on.

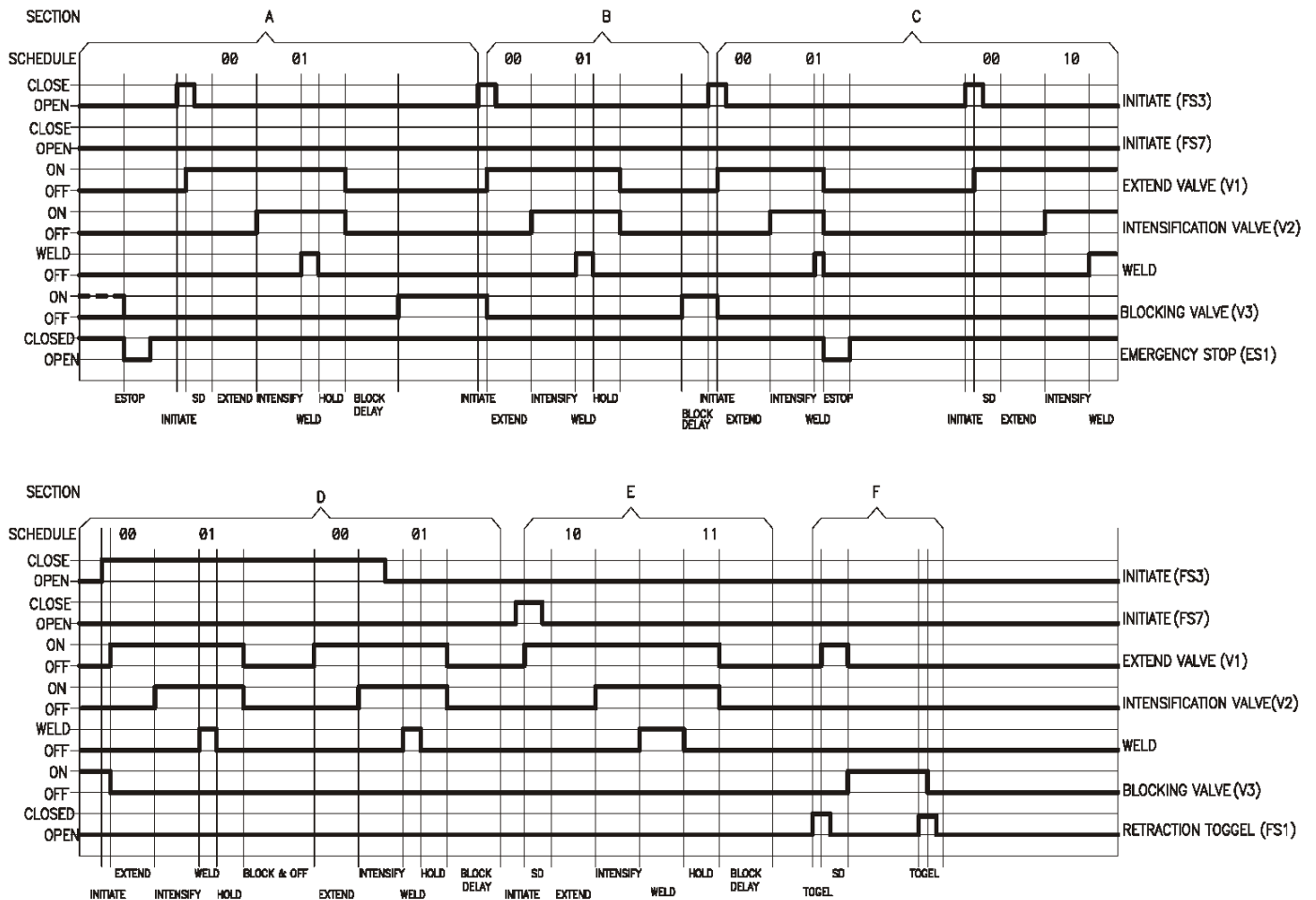


Figure 9.5.2 Air over Oil retraction diagrams

### SECTION B

Section B is the same as section A but since valve three (BLOCKING) is on, the sequence skips SQUEEZE DELAY and immediately begins with schedule 00 Squeeze (EXTEND) time.

### **SECTION C**

Section C illustrates how a sequence can be terminated by an Emergency Stop. When the Emergency Stop is detected the sequence is aborted and all valves and weld output are turned off. As can be seen when the Emergency Stop is closed, the blocking valve is not turned back on.

### **SECTION D**

Section D shows a single sequence similar to Section A, followed by a repeat sequence. Since Off time is less than BLOCKING time the sequence will repeat when the blocking time has ended.

### **SECTION E**

Section F illustrates that different schedules may be selected having common SQUEEZE DELAY and BLOCKING times.

### **SECTION F**

Section F shows how a momentary switch attached to FS1 can toggle the gun from Retracted to Non-Retracted mode or vice-versa. After a momentary closure of FS1 (Squeeze Delay) is followed by Advance Stop before blocking occurs.

## 9.6 MULTIPLE SCHEDULE OPERATION

There are applications where it is advantageous to make more than one variety of welded assembly on a single Cascade welding machine where each assembly may require different weld count and percent current settings. The flexibility of the EN1000/EN1001 Cascade control, with its 100 programmable schedules, allows for programming many combinations of schedules to meet these requirements.

For operating convenience it is sometimes desirable to select schedules from an operators position, remote from the programming panel. This may be done in several ways.

### 9.6.1 MULTIPLE INITIATION SWITCHES

TRIPLE count/TRIPLE current or 3C/3C also can be accomplished on the EN1000/EN1001 Cascade Controls. Up to three individual cascaded schedule combinations can be selected by multiple initiation switch contacts.

Extended Function [5.5.] must be set to INTERNAL Schedule Select mode or [5.5.] = 00. In this mode:

1. A switch closure between TS1-FS3 and TS1-GND then will initiate any schedule shown in the SCHEDULE window;
2. A switch closure between TS1-FS7 and TS1-GND will initiate SCHEDULE 20;
3. A switch closure between TS1-FS11 and TS1-GND will initiate SCHEDULE 40.

An example of Programming for a two-cascade control with three schedule combinations is shown in Table 9.6.1.

**Table 9.6.1** Example: Two-Cascade Control with three schedule combination

SCHEDULE	SQUEEZE	WELD/ HEAT	PERCENT CURRENT	HOLD	OFF	IMPULSES	COOL	VALVE MODE	CYCLE MODE	SLOPE MODE	SLOPE COUNT	CONTACTOR SELECT
00	30	05	50	00	00	01	00	01	02	00	00	01
01	00	05	50	10	00	01	00	01	00	00	00	02
20	30	03	60	00	00	01	00	01	02	00	00	01
21	00	03	60	10	00	01	00	01	00	00	00	02
40	30	06	70	00	00	01	00	01	02	00	00	01
41	00	06	70	15	00	01	00	01	00	00	00	02

### 9.6.2 EXTERNAL SCHEDULE SELECTION OR SINGLE INITIATION SWITCH WITH REMOTE SCHEDULE SELECTION

Up to four individual cascaded schedule combinations can be selected remotely by using the extended function [5.5.], the control is initiated at FS3 for any one of the four scheduled combinations.

SCHEDULE numbers can be externally selected in the EXTERNAL SCHEDULE SELECT Mode with use of the Extended Function [5.5.] = 01. In this mode:

1. TS1-FS7/SS1 and TS1-FS11/SS3 become binary schedule selects, and can point to one of 4 schedules 0, 20, 40, 60.
2. The control is then initiated via TS1-FS3 for any one of the 4 schedules.

**Table 9.6.2** *External Schedule select with FS7 and FS11*

SCHEDULE	TS1-FS7/SS1	TS1-FS11/SS3	INITIATION
00	OPEN	OPEN	FS3
20	CLOSED	OPEN	FS3
40	OPEN	CLOSED	FS3
60	CLOSED	CLOSED	FS3

The control is factory configured for INTERNAL Schedule Select mode, [5.5.] = 00, or TRIPLE SCHEDULE OPERATION, 3C/3C operation. See Section 5.4.3 for more information about Schedule Select options..

Examples of programming are similar to those shown for remote multiple initiation switches in Table 9.6.1.

### 9.6.3 COMPLEX CASCADE SCHEDULE PROGRAMMING

In some cascade welding operations the current and time requirements may vary from one weld to another within a given set of welds made on a single welded assembly. This could be necessary because of different metal thicknesses or types of metal being welded. Also it may be necessary to close electrodes sequentially as the welds progress.

In the example below, for a three cascade welding process, weld #1 requires a weld time of 4 cycles at 60% current. Weld #2, because one part is galvanized steel, requires 3 pulsations, and weld #3 requires up-slope because one part is aluminum. It is also necessary to close the electrodes for welds #1 and #2 simultaneously, and then release them before closing the electrodes for weld #3. The programming would be as follows:

**Table 9.6.3** *Example: Three schedules for Three-Cascade Control*

SCHEDULE	SQUEEZE	WELD/HEAT	PERCENT CURRENT	HOLD	OFF	IMPULSES	COOL	VALVE MODE	CYCLE MODE	SLOPE MODE	SLOPE COUNT	CONTACTOR SELECT
01	20	04	60	00	00	01	00	03	02	00	00	01
02	00	06	70	10	00	03	04	03	02	00	00	02
03	20	03	90	10	00	01	00	04	00	01	05	04

### 9.6.4 MULTIVALVE PROGRAMMING

In addition to cascading multiple SCR contactors for energizing multiple welding transformers, the EN1000/EN1001 Cascade controls can also be programmed to cascade multiple solenoid valves which operate multiple electrodes operating from the secondary or a single welding transformer. This system is more economical because only one SCR contactor and one welding transformer is required. It has the disadvantage of being a slower process, because a squeeze and hold time must be programmed between each weld.



An example of programming for a four-multi valve sequence is as follows:

**Table 9.6.4** *Example: Four schedules for Multivalve Cascade operation*

SCHEDULE	SQUEEZE	WELD/ HEAT	PERCENT CURRENT	HOLD	OFF	IMPULSES	COOL	VALVE MODE	CYCLE MODE	SLOPE MODE	SLOPE COUNT	CONTACTOR SELECT
01	30	03	70	10	00	01	00	<b>01</b>	02	00	00	<b>01</b>
02	30	06	80	10	00	01	00	<b>02</b>	02	00	00	<b>01</b>
03	30	05	75	10	00	05	02	<b>04</b>	02	00	00	<b>01</b>
04	30	04	90	10	00	01	00	<b>08</b>	00	01	03	<b>01</b>

## **10. OPTIONS ON EN1000/EN1001 CASCADE CONTROLS**

Optional devices can be used with EN1000 or EN1001 Multivalve Cascade Controls. Consult factory or sales representatives for details.

### **MM8 MEMORY MODULE**

The Memory Module, MM8, is designed as a backup device for any EN1000 Cascade series Control. There are two versions of this device:

MM8-RDE, for Controls with RDE option; and MM8, for all other Controls. The only difference between these two versions is the connection to the Control. The MM8-RDE is designed to plug in to a 9 pin D-Subminiature connector, the MM8 is designed to plug directly in to the J4 connector on the Control Board. See manual 700177.

### **INTEGRATED PRESSURE SENSE AND CONTROL SYSTEM (IPSC)**

#### **PRESSURE SENSOR**

The Pressure Sensor (Transducer) accurately measures air pressure and converts measurement to an electrical signal. The electrical output is a linear ratio of the sensed pressure. The Sensor is connected to the IPSC or IPS board through TS13. Signal from the sensor, IPSC or IPS board converts and sends to the Weld Control board.

The pressure may be displayed by the Weld Control if the Extended Function parameter [5.1.] is selected. The pressure reading depends on the location of the Sensor.

#### **PRESSURE CONTROL**

The Integrated Pressure Control System is designed for any application that requires automatic selection of a pre-programmed pressure, or automatic switching between different pressure settings. Weld control schedules may be chained to obtain sequential pressure changes. The benefits of the system depend on the application. The ENTRON **IPSC** system allows for sequencing of multiple pressures with one initiation. The flexibility of operation is only limited by the number of weld schedules. An **IPSC** system may be used to remove the worry of pressure settings from the operator. Also, the **IPSC** system may be used to reduce electrode wear by programming “soft set-down” during SQUEEZE. The **IPSC** system may eliminate multiple valves to simplify forging operations. Another application may serve to eliminate many valves when multiple pressures are required for selecting different pressure regulators. See manual 700178.

#### **4-20mA CONTROL AND/OR SENSE**

The IPSC or IPS Board could be used for any 4-20 mA sensor input or 4-20mA for regulated output for different applications. For example, IPS Board can be successfully used for the welding parts detection.

#### **VALVE OUTPUTS 24VDC**

Optional Valve Output Boards A/N 410322-002 or A/N 410322-003 with 24VDC output. See manual 700189.

## **RS485**

Controls with RS485 option can communicate with Remote Terminal RT4 or PC or other devices with RS485 interface, over two-wire RS485 network (ENBUS network).

The ENBUS protocol defines a message format that Controls will recognize and use, regardless of who is the host, either RT4 or some other devices. It describes the process which a host uses to request access to different Controls, how the host will respond to request from the Controls, and how errors will be detected and reported. This protocol provides an internal standard which Hosts and Controls use for parsing messages.

During communication on a ENBUS network, the protocol determines how each Host and Control will know its address, or Identification Number, recognize a message addressed to it, determine the which action will be taken, and extract any data or other information contained in the message. See manual 700171.

## **RS232**

ENTRON RS232 Interface is Full Duplex and operates in ASCII Mode with specified RS232 Command/Response protocol. Using ASCII (American Standard Code for Information Interchange) mode, each eight-bit byte in a message is sent as two ASCII characters. The main advantage of this mode is that it allows time intervals to occur between characters without causing an error. In addition, the protocol uses short ASCII commands and an interactive mode. See manual 700140.

## **S99**

The S99 Option adds 7 Binary Select Inputs to the EN1000 Cascade Series of Controls. Through the use of these added inputs the user can select any one of 99 schedules to begin a sequence from. This option is typically tied to a PLC or PC that selects the required schedule. See manual 700115.

## **TSS**

The Terminal Strip Skip Option adds 8 Binary Select Inputs on the EN1000 Cascade Series of Controls allows the user the ability to **skip** (deactivate) any schedule associated with a selected SCR contactor using an external switch. A single pole contact connection is necessary for each contactor being skipped. This option is typically tied to a PLC or PC that skip the required SCR contactor. See manual 700138.

## **9-16 VALVE EXTENSION**

The Cascade 9-16 Valve Extension Option adds additional 8 Valve Outputs on the EN1000 or EN1001 Cascade Series of Controls. See manual 700146.

## 11. ERROR CODES AND TROUBLESHOOTING

Please refer to other manual pages and wiring diagrams for location of fuses, terminal strips, etc.

### 11.1 ERROR CODES

<b><u>ERROR</u></b>	<b><u>POSSIBLE CAUSE</u></b>	<b><u>REMEDY</u></b>
Data/Schedule Display E.r. 01.	Error Code #01. Temp. Limit Switch Open /Overheated	Wait for the Temperature Limit Switch to cool, or Check for open circuit. <b>See section 4.3 and 4.5, and 5.4.6.</b>
Data/Schedule Display E.r. 02.	Error Code #02. FS1 AND FS7 both closed	Two Stage Operation not allowed with FS7. <b>See section 4.3 and 4.4.</b>
Data/Schedule Display E.r. 03.	Error Code #03. FS1 AND FS11 both closed.	Two Stage Operation not allowed with FS11. <b>See section 4.3 and 4.4.</b>
Data/Schedule Display E.r. 04.	Error Code #04. Attempt to weld while in Program Mode.	Return to Operate Mode. <b>See section 2.1 and 6.</b>
Data/Schedule Display E.r. 05	Error Code #05. FS1,FS3,FS7,FS11, closed to GND before power on or before Emergency Stop is re-closed after being opened.	Initiations must be open at power on or after an ES (Emergency Stop). <b>See section 1.1, 4.3, and 4.4.</b>
Data/Schedule Display E.r. 06.	Error Code #06. Backstep or Retraction is closed too long or at start of sequence.	Open TS1-WFS1/AUX1. <b>See section 4.3, 4.5, and 5.4.6.</b>
Data/Schedule Display E.r. 07.	Error Code #07. FS1 initiated while another seq. active.	Open TS1-FS1. <b>See section 4.3, 4.5, 5.4.3, 9.3.</b>
Data/Schedule Display E.r. 08.	Error Code #08. FS3 initiated while another seq. active.	Open TS1-FS3. <b>See section 4.3, 4.5, 5.4.3, 9.3.</b>
Data/Schedule Display E.r. 09.	Error Code #09. FS7 initiated while another seq. active.	Open TS1-FS7. <b>See section 4.3, 4.5, 5.4.3, 9.3.</b>
Data/Schedule Display E.r. 10.	Error Code #10. FS11 initiated while another seq. active.	Open TS1-FS11. <b>See section 4.3, 4.5, 5.4.3, 9.3.</b>
Data/Schedule Display E.r. 11.	Error Code #11. Control BD. Control Relay problem.	Replace Control Board.
Data/Schedule Display E.r. 12.	Error Code #12. Control Bd. Hardware error.	Replace Control Board.
Data/Schedule Display E.r. 13.	Error Code #13. Full conduction detected	Change to higher Welding Transformer Tap. <b>See section 5.4.10.</b>

<b><u>ERROR</u></b>	<b><u>POSSIBLE CAUSE</u></b>	<b><u>REMEDY</u></b>
Data/Schedule Display E.r. 14	Error Code #14. EEPROM error. Memory corrupt due to electrical transients or bad EEPROM memory chip.	1. Clear all Schedules and E.F. 2. Re-route wiring in Cabinet. Replace Control Board, if necessary. <b>See section 4.6, 5.4.5.</b>
Data/Schedule Display E.r. 15.	Error Code #15. Pressure switch open too long.	1. Close Pressure Switch 2. Check wiring for open. <b>See section 1.1, 4.3, 4.5.</b>
Data/Schedule Display E.r. 17,18.	Error Code #17, or 18. Nominal AVC reading too low/high.	1. Reprogram Nominal setting. 2. Check [C.C.] value. <b>See section 5.4.4.</b>
Data/Schedule Display E.r. 19,20.	Error Code #19, or 20. AVC reading too low or too high.	1. AVC could not compensate. 2. Change TAP or PERCENT. <b>See section 5.4.4.</b>
Data/Schedule Display E.r. 22.	Error Code #22. +18 Vdc out of range. High line voltage.	1. Line voltage too high. 2. Wrong voltage jumper settings. <b>See section 4.1.</b>
Data/Schedule Display E.r. 23,24	Error Code #23, or 24. Manual power factor error.	1. Full Conduction reached. 2. Set automatic power factor. <b>See section 5.4.10.</b>
Data/Schedule Display E.r. 26	Error Code #26. SCR Contactor short detected.	1. Check contactor for short. 2. Check Firing Board.
Data/Schedule Display E.r. 27.	Error Code #27. Retraction Valve is not ON.	Turn ON retraction valve via TS1-WFS1/AUX1. <b>See section 5.4.7, 4.5.</b>
Data/Schedule Display E.r. 28.	Error Code #28. Process Output 10 error.	Attempting to Weld in “No Weld” with [ P O ] = 10. <b>See section 5.4.7.</b>
Data/Schedule Display E.r. 32	Error Code # 32. Schedule data out of range or invalid data in memory or EEPROM memory corrupt due to electrical transients.	Clear Schedule with corrupted data or Clear Extended Functions. See E.r. 14 remedy. <b>See section 4.6, 5.4.5.</b>

**NOTE:** For list of all Error Codes refer to APPENDIX A, or Application Note 700158.

## 11.2 TROUBLESHOOTING

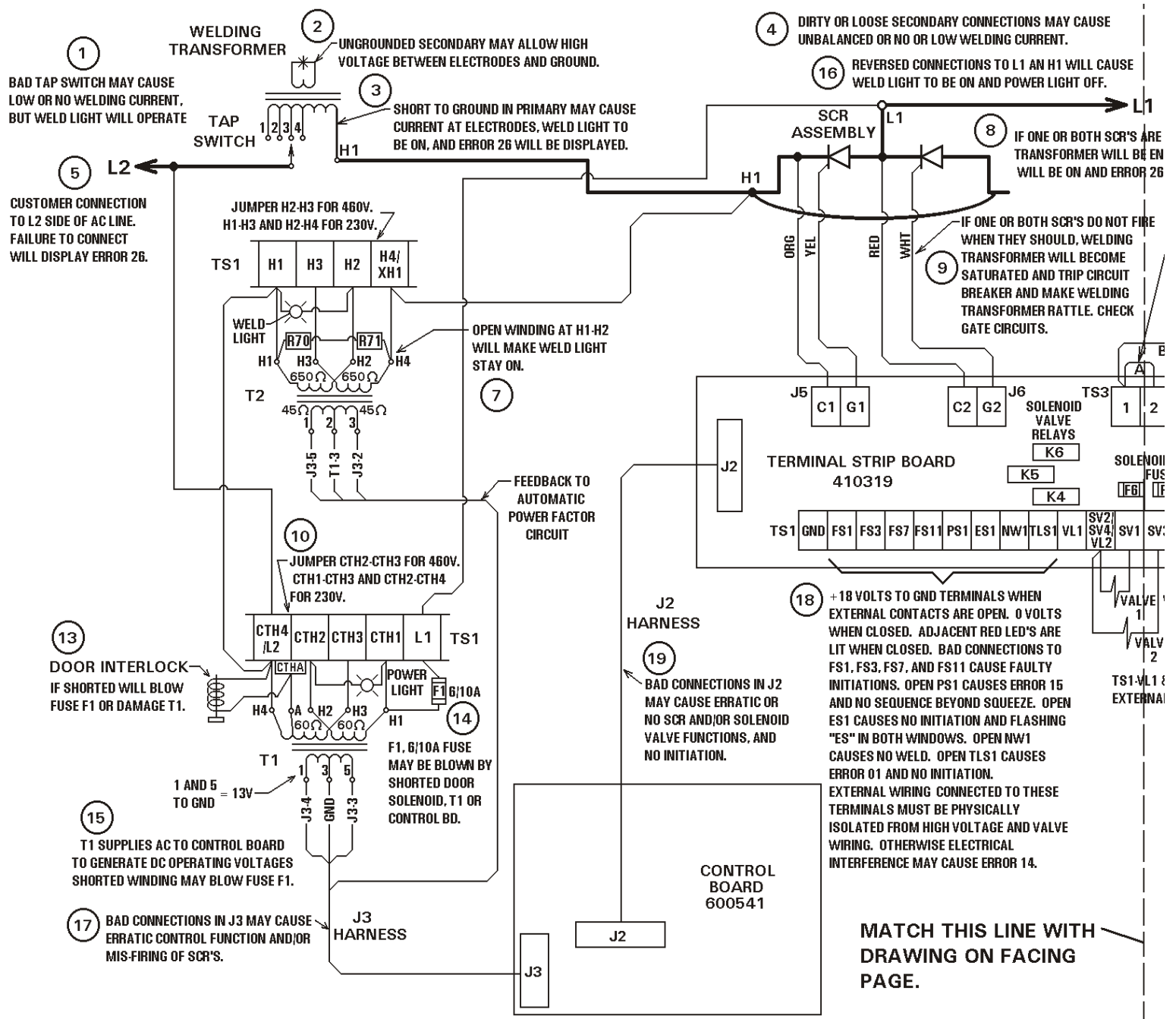
Please refer to other manual pages and wiring diagrams for location of fuses, terminal strips, etc.

It is very easy to press a schedule button and select a different schedule accidentally. This causes no problem when initiating on FS7 or FS11. However, when initiating on FS3 always verify that the schedule to be initiated is displayed prior to initiation. Conversely when the default setting of [5.5.] = 00 is used, FS7 and FS11 will select schedule 10 and 20 respectively. The control may display any schedule at any time. Foot switch (FS) connections and Extended Function [5.5.] determine which schedule will be executed. Use care when programming to be sure operating parameters are stored in the schedule to be initiated.

<b><u>TROUBLE</u></b>	<b><u>POSSIBLE CAUSE</u></b>	<b><u>REMEDY</u></b>
Power Switch ON but no Display.	<ol style="list-style-type: none"> <li>1. Fuse F1, type KLDR 1/4 or FNQR 1/4, control fuse blown.</li> <li>2. Defective Circuit Breaker.</li> <li>3. Defective Control Board.</li> </ol>	<ol style="list-style-type: none"> <li>1. Check that control is being powered by all phases.</li> <li>2. Replace Circuit Breaker.</li> <li>3. Replace Control Board.</li> </ol>
Control will not initiate.	<ol style="list-style-type: none"> <li>1. Initiation switch(s) defective.</li> <li>2. Loose or broken wire(s) at initiation switch.</li> <li>3. Fuses F6 - F8 valve fuses Blown.</li> <li>4. Defective Control/Display or Terminal Strip/Firing PCB.</li> </ol>	<ol style="list-style-type: none"> <li>1. Replace switch(s).</li> <li>2. Check for loose or broken wire(s) at initiation switch(s) and at customer terminal strip (FS1, FS2, etc.)</li> <li>3. Check valve solenoid coil.</li> <li>4. Replace board with another board stamped with the same A/N.</li> </ol>
Control initiates, valve light comes on, but electrodes <u>do not</u> close.	<ol style="list-style-type: none"> <li>1. Solenoid valve circuit mis-wired or broken wires.</li> <li>2. Hydraulic (or air) line blocked.</li> </ol>	<ol style="list-style-type: none"> <li>1. Check terminals VL1, SV1 and SV2, and associated wiring (see wiring diagram).</li> <li>2.a) Check pressure.</li> <li>2.b) Repair or replace air accessories.</li> </ol>
Control does not initiate, but welder head or arms close.	<ol style="list-style-type: none"> <li>1. Mis-wired for single stage operation.</li> <li>2. Second stage pilot switch open.</li> <li>3. Defective Control/Display or Terminal Strip/Firing PCB.</li> </ol>	<ol style="list-style-type: none"> <li>1. Check pilot switch wiring.</li> <li>2. Check for proper operation of pilot switch. Be sure first stage closes before second stage.</li> <li>3. Replace board with another board stamped with the same A/N.</li> </ol>
Control initiates, but stays in Squeeze.	<ol style="list-style-type: none"> <li>1. Pressure Switch not closing.</li> <li>2. Defective Control/Display or Terminal Strip/Firing PCB.</li> </ol>	<ol style="list-style-type: none"> <li>1.a) Check for defective or malfunctioning pressure switch connected to PS1&amp;GND.</li> <li>1.b) If no pressure switch is used, jumper PS1 &amp; GND.</li> <li>2. Replace board with another board stamped with the same A/N.</li> </ol>

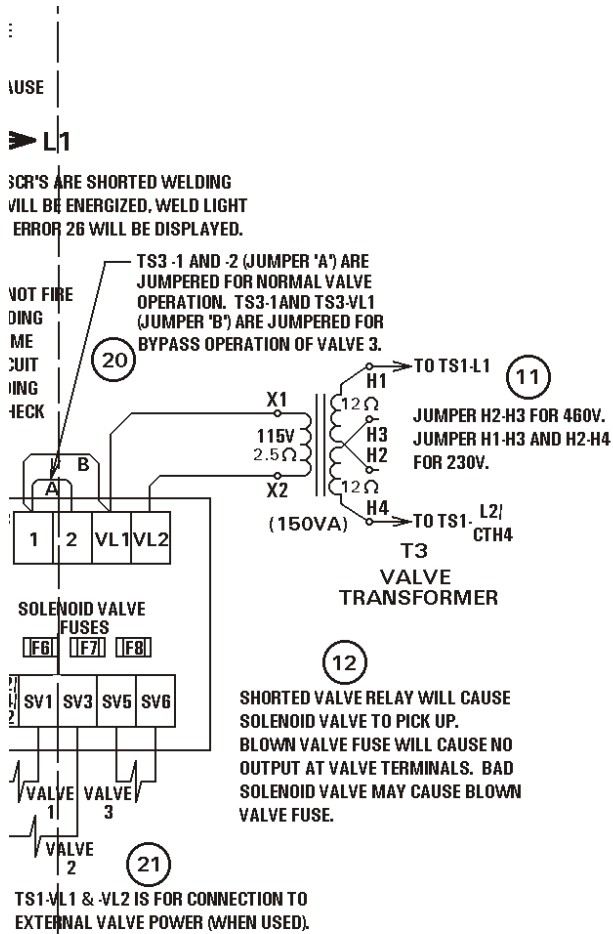
<b><u>TROUBLE</u></b>	<b><u>POSSIBLE CAUSE</u></b>	<b><u>REMEDY</u></b>
Control initiates and sequences properly, but solenoid valve chatters.	<ol style="list-style-type: none"> <li>1. Solenoid valve coil.</li> <li>2. Defective Control/Display PCB.</li> <li>3. Defective Terminal Strip/Firing Board.</li> </ol>	<ol style="list-style-type: none"> <li>1.a) Check that valve supply voltage is not varying below tolerance, -15%.</li> <li>1.b) Check if valve coil is proper voltage.</li> <li>1.c) Insufficient air pressure.</li> <li>1.d) Loose connections in valve wiring.</li> <li>2. Replace board with another board stamped with the same A/N.</li> <li>3. Replace board. See wiring diagram for correct Assembly Number.</li> </ol>
Control sequences but will not weld.	<ol style="list-style-type: none"> <li>1. External Weld/No-Weld Switch, or Weld/No-Weld Switch on front panel of control.</li> <li>2. Welding transformer not connected.</li> <li>3. Welding transformer secondary open.</li> <li>4. Defective Terminal Strip/Firing PCB.</li> <li>5. Defective Control/Display PCB.</li> <li>6. Excessive Ripple in secondary.</li> </ol>	<ol style="list-style-type: none"> <li>1.a) Check both for proper operation and/or loose wires on NW1 &amp; GND.</li> <li>1.b) If no external Weld/No-Weld Switch is used, put jumper across NW1 &amp; GND.</li> <li>2. Connect H1 and H2 to Lugs in the control.</li> <li>3. Check corroded or open connections. Be sure welding electrodes close on work.</li> <li>4. Replace board. See wiring diagram for correct Assembly Number.</li> <li>5. Replace board with another board stamped with the same A/N.</li> <li>6. Check for missing phase.</li> </ol>
Weld too cool.	<ol style="list-style-type: none"> <li>1. Line voltage drop.</li> <li>2. Excessive pressure at electrodes.</li> <li>3. Weld Count too short.</li> <li>4. Excessive tip "mushrooming".</li> </ol>	<ol style="list-style-type: none"> <li>1. KVA demand for welding transformer too high for input power line. Check line voltage.</li> <li>2. Check air system regulator.</li> <li>3. Increase Weld Count duration.</li> <li>4. Properly dress tips.</li> </ol>
Weld too small.	<ol style="list-style-type: none"> <li>1. Percent current too low.</li> <li>2. Electrode face too large.</li> </ol>	<ol style="list-style-type: none"> <li>1. Increase value of Percent Current.</li> <li>2. Select correct electrode face diameter.</li> </ol>
"HOT" Welds	<ol style="list-style-type: none"> <li>1. Insufficient air pressure.</li> <li>2. Weld Count set too high.</li> <li>3. Percent Current set too high.</li> <li>4. Electrode diameter too small.</li> </ol>	<ol style="list-style-type: none"> <li>1. Check air supply and accessories.</li> <li>2. Reduce Weld Count duration.</li> <li>3. Decrease value of Percent Current.</li> <li>4. Dress or replace tip with proper size.</li> </ol>
Inconsistent Welds	<ol style="list-style-type: none"> <li>1. Varying air pressure.</li> <li>2. Work not square with electrodes.</li> <li>3. Poor part fit-up.</li> <li>4. Dirty material to be welded.</li> <li>5. Loose connection.</li> </ol>	<ol style="list-style-type: none"> <li>1. Check air supply and accessories.</li> <li>2. Check welding fixtures set-up or electrode alignment.</li> <li>3. Check parts for proper fit-up.</li> <li>4. Work should be free from excessive dirt, paint and oxides.</li> <li>5. Check for all terminals and/or lugs connections inside the Cabinet.</li> </ol>

# 11.3 TROUBLESHOOTING GUIDE



**NOTE:** This Troubleshooting guide is originally created to help troubleshooting the EN1000 Series Controls, but it may be useful to troubleshooting EN1000 Cascade Series Controls.





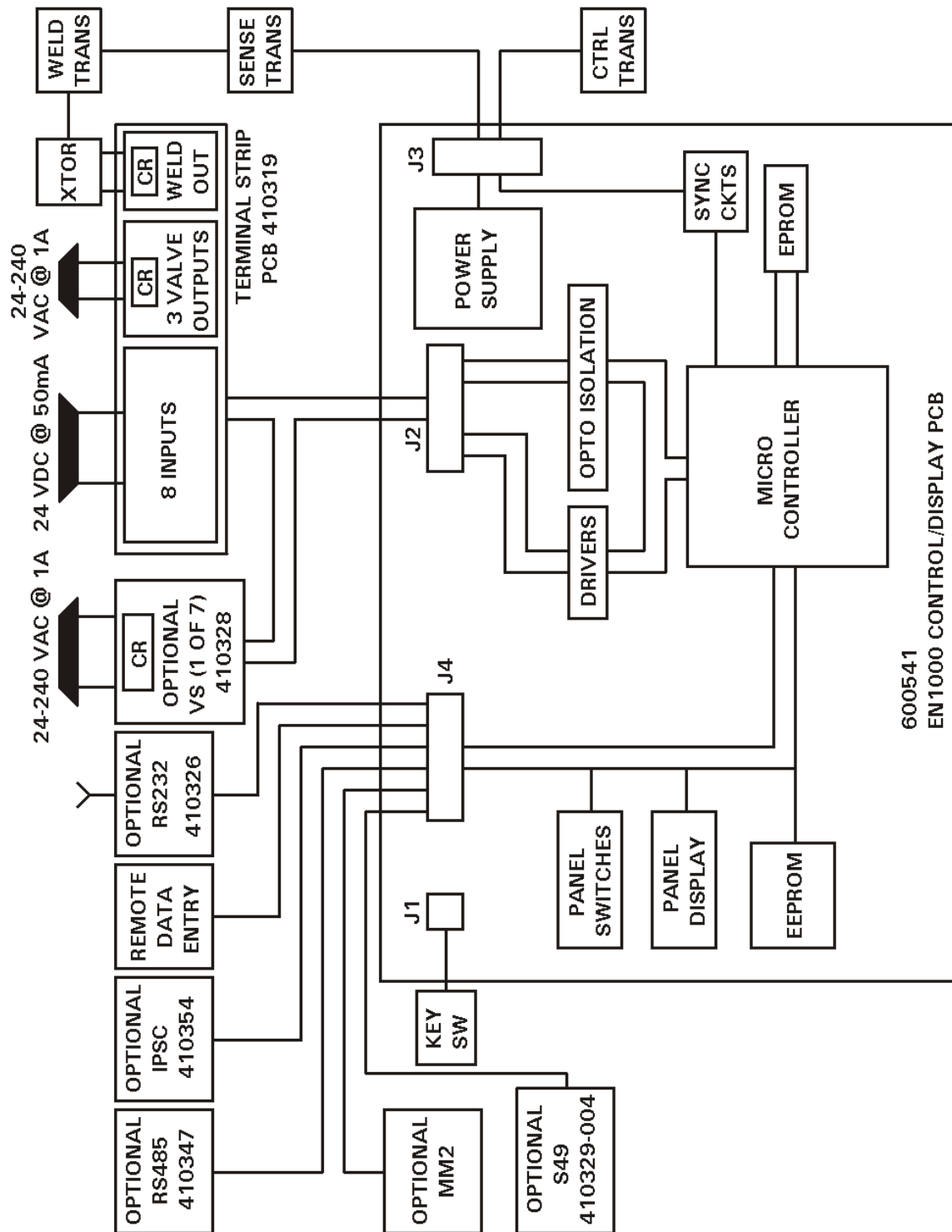
MATCH THIS LINE WITH DRAWING ON FACING PAGE.

TROUBLE SYMPTOM	SEE NOTE #
A. Power Light Off	14
B. Power Light Off, Weld Light On	16
C. Weld Light On	8, 3, 7
D. One or more Solenoid Valves Energized	12
E. Blowing fuse F1	10, 13, 14, 15
F. No Initiation	18, 19
G. Control goes through sequence but electrodes do not close.	11, 12, 19
H. Control and machine go through sequence but there is no current and Weld Light does not come on.	18, 19
J. Control and machine go through sequence but there is no weld current. Weld light comes on.	1, 4
K. Blowing Valve Fuses	12
L. Tripping Circuit Breaker	9, 17, 19
M. High Voltage between Welding Electrodes and Ground.	2
N. Welding Current occasionally drops to a low level.	1, 4
P. Erratic Sequence or Valve operation	17, 19
R. Sequence will not advance beyond Squeeze. (Electrodes remain closed, no Weld Current)	18
S. Error 26 displayed immediately when power is turned on.	3, 5, 8
T. Error 14 displayed on Front Panel.	18
U. Jumper A on TS3-1 to -2. Provides normal operation of Valve 3. Jumper B provides bypass operation of Valve 3, some EF's and PO's will not work without Jumper B in place.	20
V. When external valve power source (24-240 VAC) is used it connects here. Remove and insulate connections to TS3-VL1 and -VL2.	21

## TROUBLE SHOOTING GUIDE EN1000-SERIES CONTROLS

451014 A

# 11.4 BLOCK DIAGRAM



## **12. ENTRON LIMITED WARRANTY AND FACTORY SERVICE**

ENTRON Controls, LLC., warrants that all ENTRON control panels, **EXCEPT** the silicon controlled rectifiers (SCRs), SCR and IGBT assemblies, circuit breakers, and electro-mechanical contactors, are free of manufacturing defects for a period of **TWO YEARS** from the date of original purchase and, in the event of a manufacturing defect, ENTRON will repair or replace, at its discretion, the defective part without any cost for parts or labor.

All silicon controlled rectifiers, SCR and IGBT assemblies, and circuit breakers in ENTRON control panels are covered by a limited warranty from the original manufacturer (other than ENTRON). If these parts fail because of a manufacturing defect, they will not be repaired or replaced by ENTRON, but will be returned by ENTRON to the original manufacturer in accordance with said manufacturer's warranty.

To obtain repairs or replacement parts under this warranty, the defective parts must be returned, prepaid, to ENTRON Controls, LLC., 601 High Tech Court, Greer, SC 29650. Please send your repair to the attention of "service" with a description of the problem you are experiencing, contact person, and phone number.

**EXCLUSIONS: This warranty does not cover damage by accident, misuse, unauthorized repair or modification to any control assembly by the customer.**

**IMPORTANT NOTE: The warranty period is considered from the date of shipment and is tracked by a serial number code.**

### **USE OF "OUT OF WARRANTY" REPAIR SERVICE:**

To obtain service for any printed circuit board assembly after two years from the date of purchase, send the assembly, prepaid, to ENTRON Controls, LLC., and ENTRON will repair the printed circuit board assembly and return it to you without further warranty on its part. Additional service charges may be invoiced at time of shipment

**Your ENTRON Controls, LLC., representative is always available to assist you with your control or welding problems. Our sales representatives, Original Equipment Manufacturers, Dealers and Distributors are always supported by direct factory assistance. Do not hesitate to call for prompt, professional assistance – 864-416-0190. There is no charge for this assistance.**

# APPENDIX A

## ERROR CODES\*

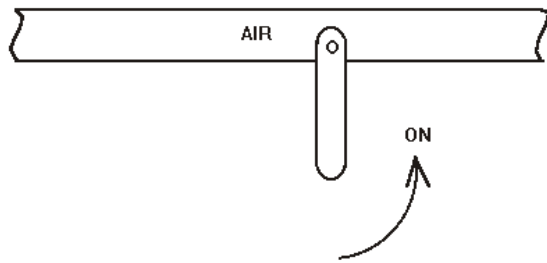
### Error Code Reason or Cause

01	Temperature Limit Exceeded (TLS open). / Incorrect [b.S.] or [P.O.] programmed.
02	FS1 & FS7 are both active.
03	FS1 & FS11 are both active.
04	Weld initiated while in program mode.
05	FS1, FS3, FS7, or FS11 is active upon power up.
06	Back-step is active too long. /Input switch closed. /Incorrect [b.S.] or [P.O.] programmed.
07	FS1 still active after weld.
08	FS3 still active after weld.
09	FS7 still active after weld.
10	FS11 still active after weld.
11	Safety still active after weld.
12	Hardware error is detected.
13	Full conduction is detected.
14	EEPROM error is detected, refer to Application Note 700127.
14 - flashing	Invalid data in EEPROM.
15	Pressure Switch is open too long.
16	Emergency Stop is active.
17	Nominal AVC reading is too low.
18	Nominal AVC reading is too high.
19	AVC reading is too low.
20	AVC reading is too high.
21	+5VDC is out of range.
22	+20VDC is out of range.
23	Maximum firing angle exceeded during AVC correction.
24	Minimum firing angle exceeded during AVC correction.
25	Power factor measured as zero.
26	Sense input active while not welding. / Shorted SCRs. / Incorrect wiring or missing L2.
27	Retraction not active upon initiation.
28	Front Panel "No Weld" switch is active for [P.O.]=10.
29	Schedule out of range for [S.S.]=03 when using S49 or S99 option.
30	Over Current ( <i>EN1000 only</i> ).
31	IIC Error.
32	Invalid data in EEPROM.
33	MM2 is not found. Memory Module required.
34	Downloading data from MM2 Checksum Error.
35	Copy data to MM2 Checksum Error.
36	Pressure Sense input is too low or too high.
37	Calibration data out of range ( <i>EN1001 only</i> ).
38	DC bus voltage is too low ( <i>EN1200 only</i> ).
39	DC bus voltage is too high ( <i>EN1200 only</i> ).
40	Control with programmed ID not found on the RS485 network ( <i>RT4 only</i> ).
41	Message is not received from the Control ( <i>RT4 only</i> ).
42	Communication Error ( <i>RT4 only</i> ).
43	Checksum error in Data bytes ( <i>RT4 only</i> ).
44	DC bus voltage is too high. Send signal to Circuit Breaker Shunt Trip. ( <i>EN1200/EN1201 only</i> ).
45	One or two of the three Phases are missing ( <i>EN1200/EN1201 only</i> ).
46	Setup Failed. Control Failed to adjust for signal level ( <i>EN1001/EN1001 Cascade</i> ).
E.r.HI or E.r.LO	Flashing on the DATA displays if Control is unable to correct and maintain constant current during a weld. Generally shown after the weld for [P.O.]=12, 13,14, 22, 23, 24 or 25 ( <i>EN1001 only</i> ).
47	Over Current from Primary Current Sensor ( <i>EN1200/EN1201 only</i> ).
48	SCR's Firing Board is not ready for weld ( <i>EN1200/EN1201 only</i> ).

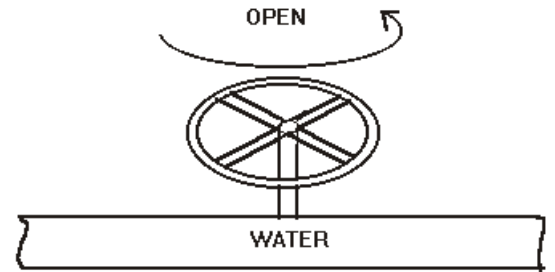
\*These Error Codes affect Controls in Series EN1000, EN1001,EN1000B, EN11003, EN1000 Cascade, EN1200, EN1201, EN1280, TW1280, EN1380, EN1500 and EN1501.

# APPENDIX B

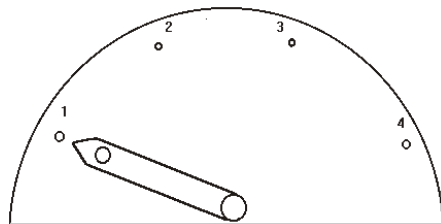
## INTRODUCTION TO PROGRAMMING EN1000 SERIES CONTROLS



**Fig. B1** Turn ON Air supply to machine

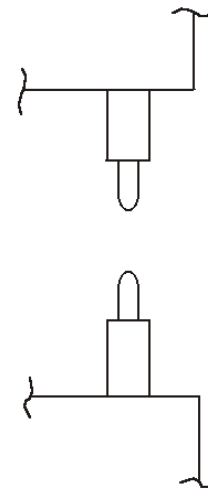


**Fig. B2** Turn ON Water supply to machine



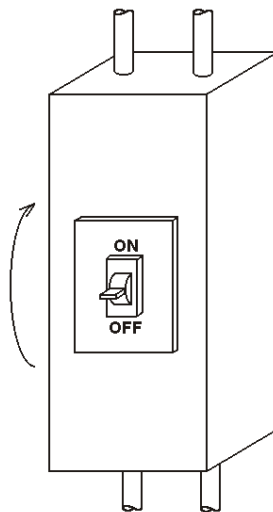
**Fig. B3** Set welder switch LOW

Be sure welder head or arms are fully retracted!

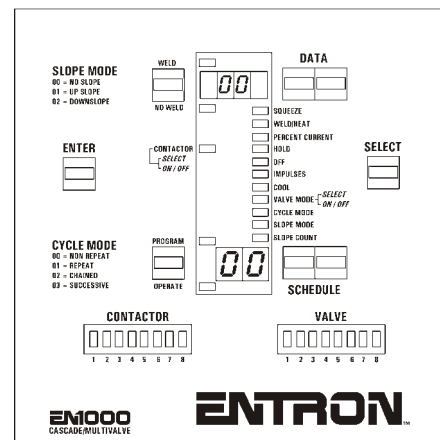
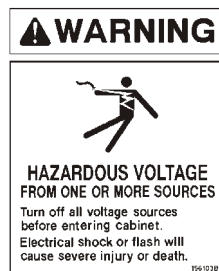


BE SURE WELDING HEADS ARE FULLY RETRACTED

**Fig. B4** Retracted Head or arms



**Fig. B5** Turn ON Power to Control



**Fig. B6** POWER ON light indicator

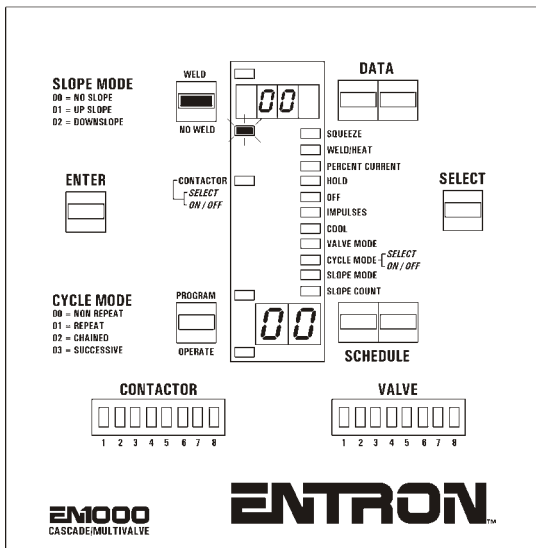


Fig. B7 Put Control in NO WELD

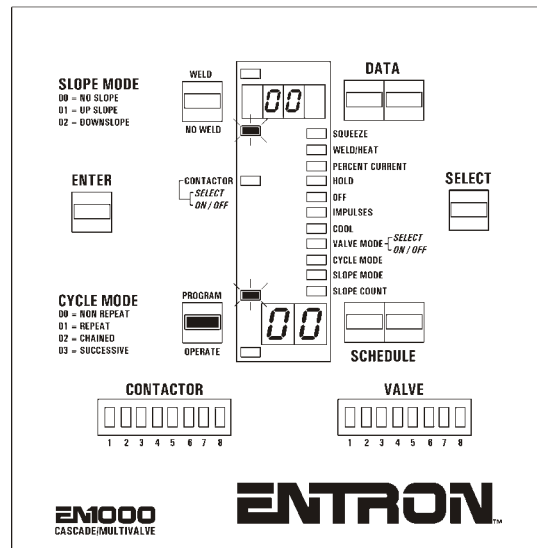


Fig. B8 Put Control in PROGRAM Mode

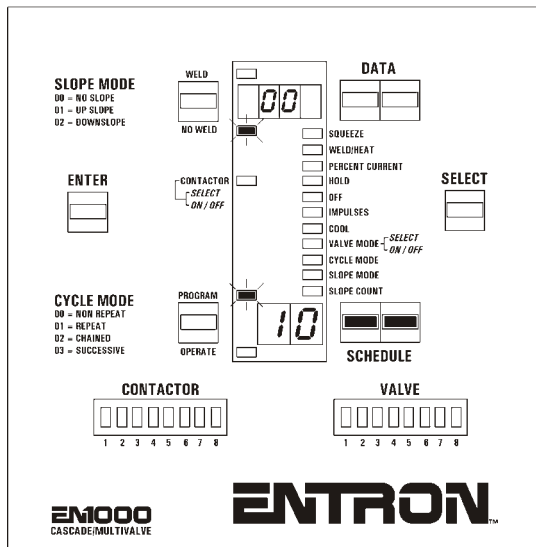


Fig. B9 Choose SCHEDULE to program

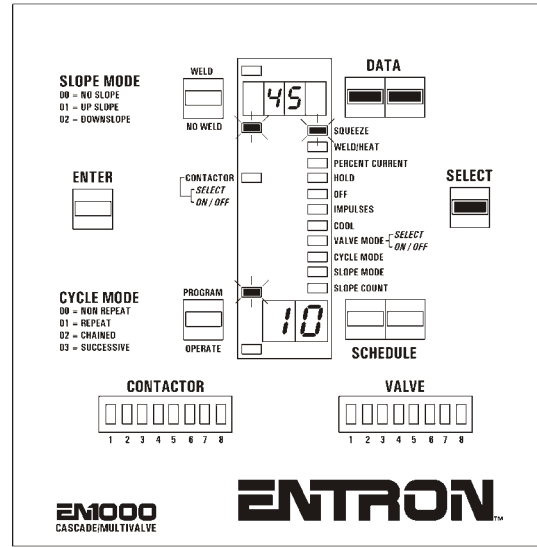


Fig. B10 SELECT Squeeze and program 30 to 60 cycles; e.g. 45 cycles

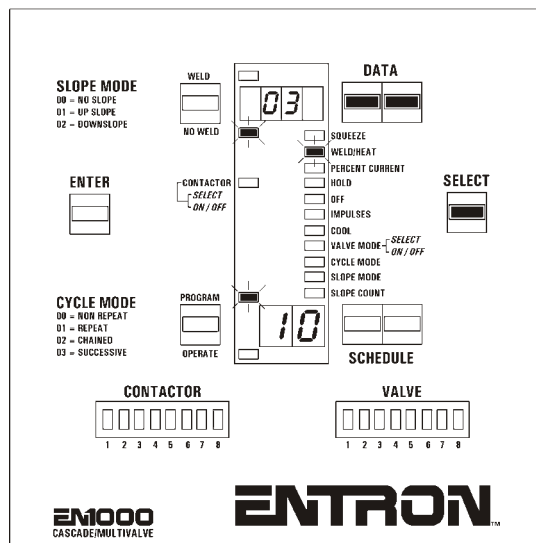


Fig. B11 SELECT Weld/Heat and program 2 to 3 cycles; e.g. 3 cycles

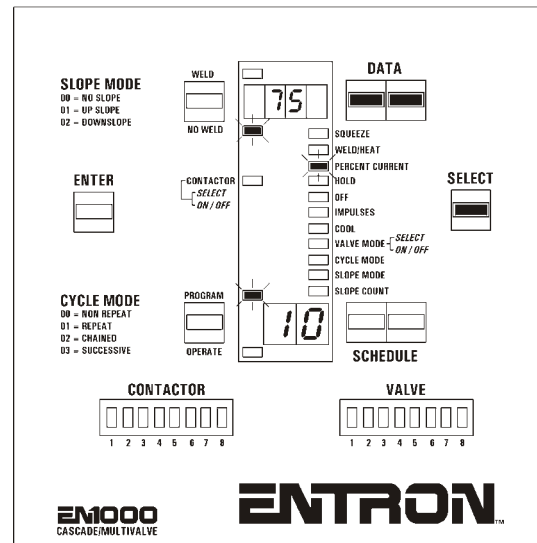
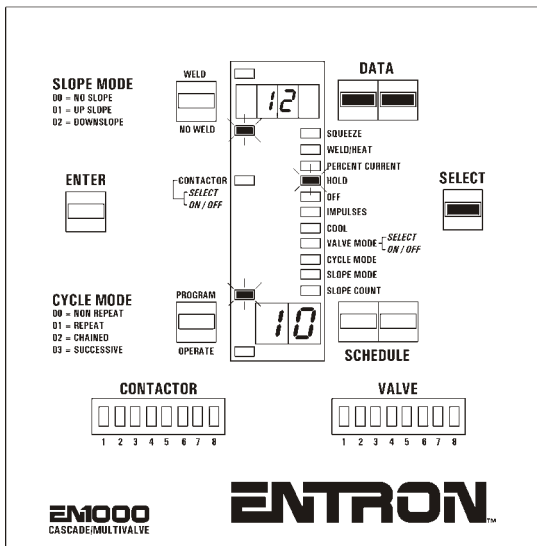
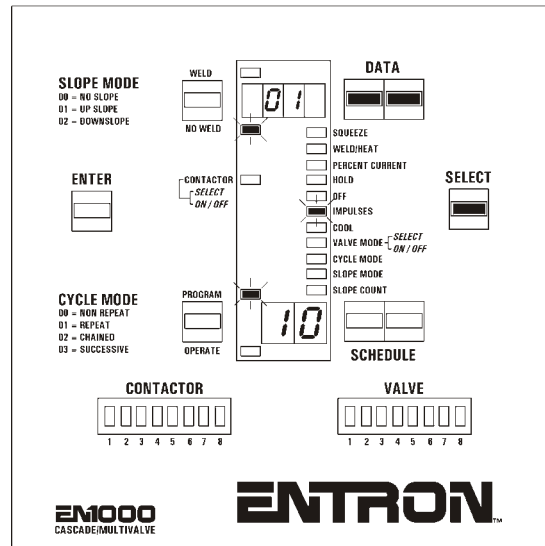


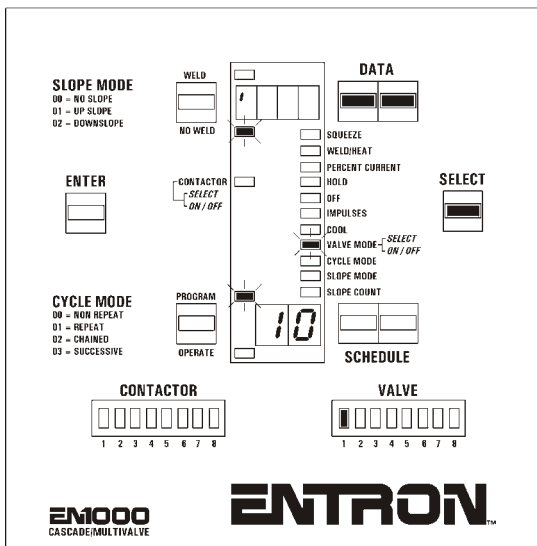
Fig. B12 SELECT Percent Current and program 70% to 80%; e.g. 75%



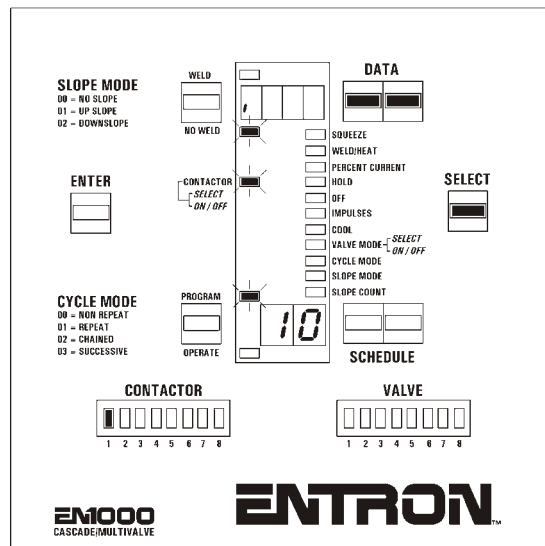
**Fig. B13** SELECT Hold and program 10 to 15 cycles; e.g. 12 cycles



**Fig. B14** SELECT Impulses and program 01 (one pulse)



**Fig. B15a** SELECT Valve Mode and program 01 (Valve 1)



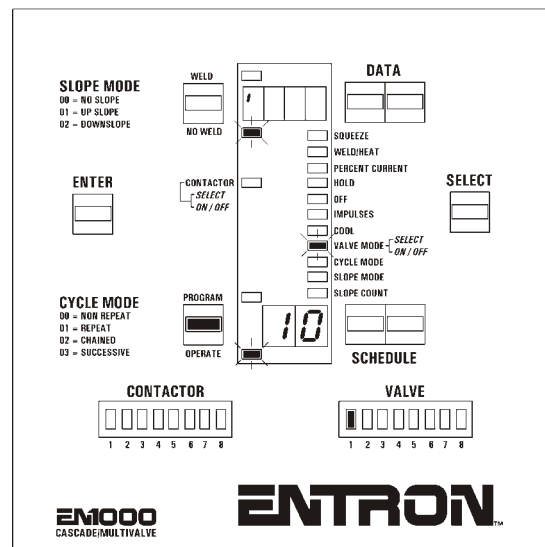
**Fig. B15b** SELECT Contactor and program 01 (Contactor 1)

**NOTE:** Press ENTER whenever new values for any parameter are programmed.

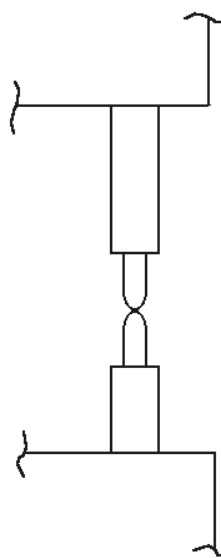
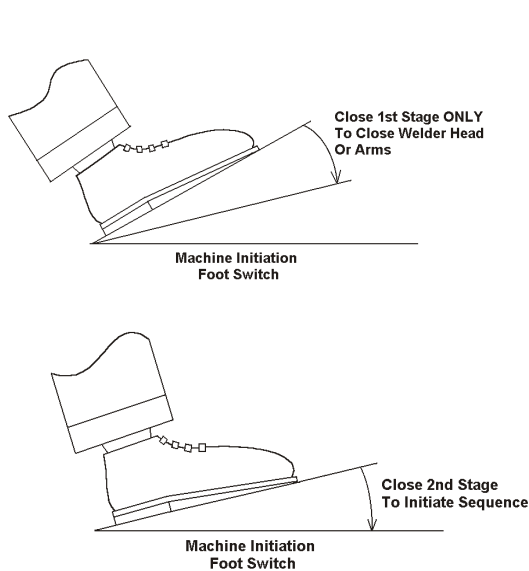


**ENTER**

Make sure that all unnecessary parameters are set to "00" before going to OPERATE Mode.



**Fig. B16** Put Control in OPERATE Mode



**Fig. B17** Closed Head or arms

Make sure machine head (or arms) close properly. (On machines with single stage initiation, depressing the foot switch will sequence the control but will not weld.)

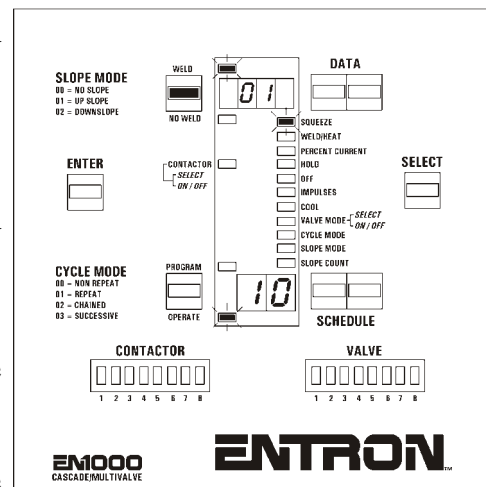
Machine will sequence but **will not weld**, then the head (or arms) will retract.

Put the Control in WELD mode.

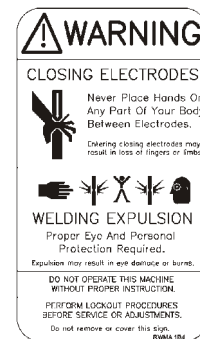
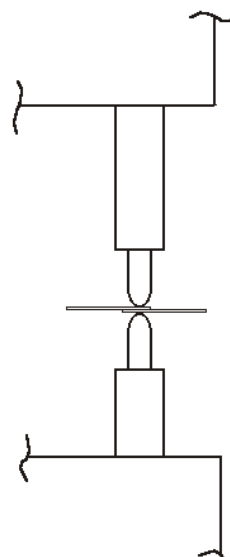
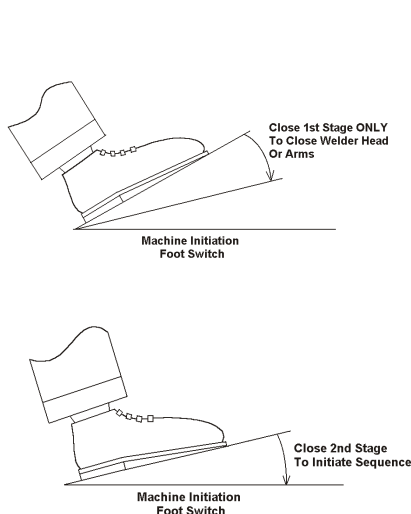
Place sample parts to be welded between electrodes, and initiate weld sequence again.

Machine head (or arms) will close on parts to be welded. (On machines with single stage initiation, depressing the foot switch will sequence the machine and weld.)

Machine will go trough sequence, and **weld**, then the head (or arms) will retract.



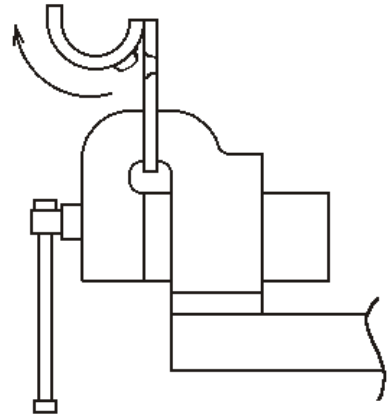
**Fig. B18** Put Control in WELD mode



**Fig. B19** Welding the sample part



Before running production quantities of welded parts ENTRON recommends destructive testing of the welds. Set the welding machine to RWMA recommended standards. Weld the parts. Then clamp one end of the welded part in a vise and **PEEL** the other side back against the weld. Ideally, in low carbon steel, the weld will pull a hole thru one or the other parent materials.



**To make the best possible weld for the material to be welded use:**

1. The **LOWEST** Transformer Tap setting,
2. The **HIGHEST** Percent Current setting, and
3. The **SHORTEST** Weld Count setting.

**Fig. B20** Destructive test

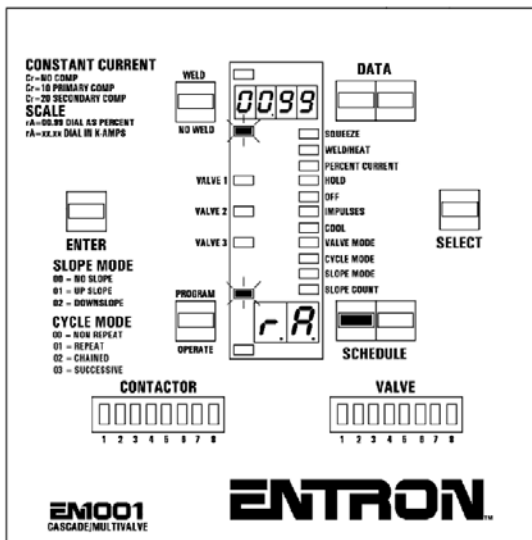
## CONSTANT CURRENT PROGRAMMING AND SETUP (EN1001 only)

Put Control in **PROGRAM** Mode, as shown in Figure B8. Find the Extended Functions by pressing the **SELECT** button until [ *EF* ] appears in the DATA Display. Use **SCHEDULE** push-buttons to scroll through the Extended Functions.

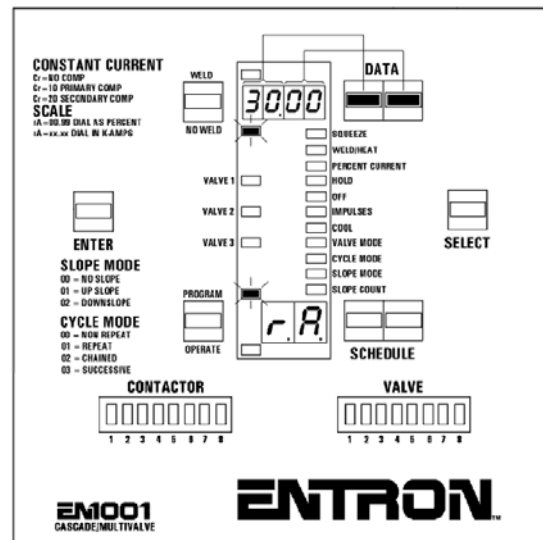
Based on current sensor and desired constant current mode, program [ *L.r.* ] and [ *r.A.* ] accordingly to enable Constant Current. For [ *L.r.* ] = 32 or 33, only kA mode is possible, and [ *r.A.* ] must be programmed according to desired range, as shown in the Table 8.4.1. Programming [%] mode is shown on Figure B21, and programming range of 30 kA for [kA] mode is shown on Figure B22.

Only two DATA push-buttons are used for programming four digits data parameters. Press **right DATA** button to increase by one, press and hold to increase by ten. Press **left DATA** button to increase by 100, and press and hold to increase by 1000.

After selecting and programming desired constant current mode, run setup only if necessary.



**Fig. B21** Program Range for [%] mode



**Fig. B22** Program Range for [kA] mode

For Primary Coil Sensing, program 10, 11, 12, ... , 18, or 19.

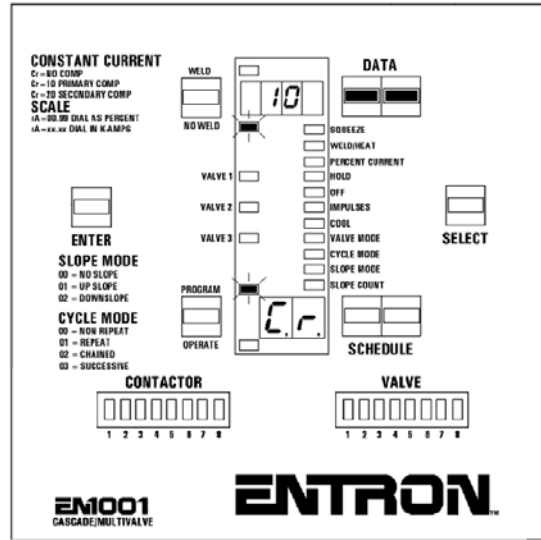
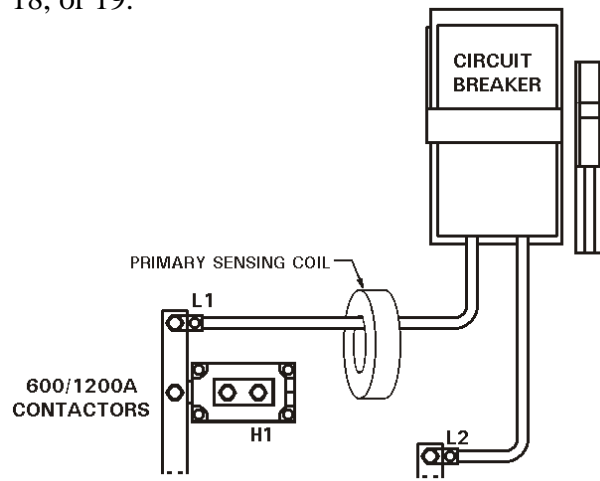


Fig. B23 For Primary Sensing Coil

For Hall Effect Secondary Sensing, program 20 or 21.

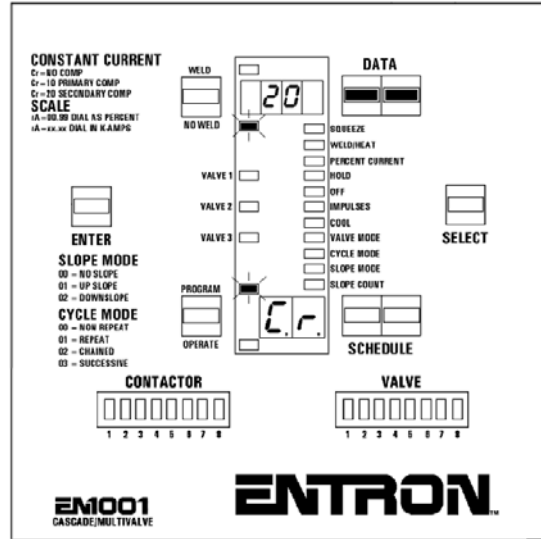
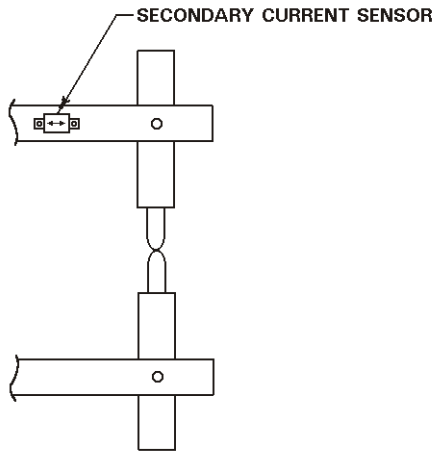


Fig. B24 For Secondary Hall-Effect

For Secondary Rogowski Coil Sensing, program 30, 31, 32, or 33.

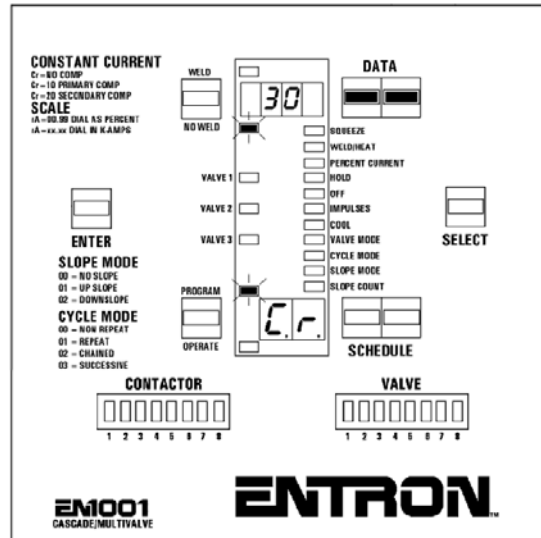
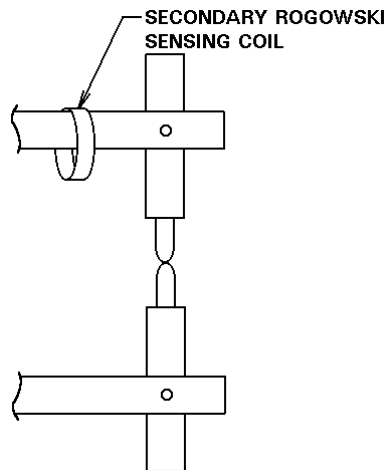


Fig. B25 For Secondary Rogowski Coil

In order to self-adjust gains for current sensor signal, Control must automatically perform **Setup Procedure**, as described in section 8.1.3. This Setup Procedure is necessary only for following constant current modes:

1. [C.r.] = 10, 11 - for Primary Coil;
2. [C.r.] = 20, 21 - for Hall-Effect Secondary;

NOTE: When setup procedure is **not** allowed due to some circumstances, even if Hall-Effect current sensor is used, a manual range selection is possible without running the setup, as described in Section 8.3.2.

3. [C.r.] = 30, 31 - for Rogowski Secondary.

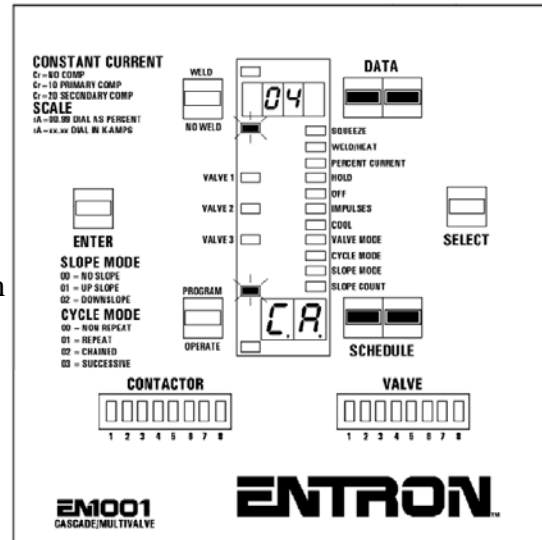


Fig. B26 Prepare Control for Set-up

After Programming [C.A.]=04 and 05, as shown on Figure B26, follow the setup procedure described in Section 8.1.3.

Initiate the control using the FS3 terminal input ONLY. Bring the heads together on a previously WELDED part. Hold the initiation contacts closed while the machine sets up the Constant Current parameters. When a Primary Sensing Coil is used, this initiation will cause the Control to fire several times then count down on the dial plate from 99 (99, 98, 97, ..., to 20). The display will switch to Schedule 00 when the Constant Current routine has completed successfully. When Secondary Hall Effect Sensor is used, some adjustment of the mounting may be required, as described in 8.3.

NOTE: Setup must be run in spot welding mode. When setting up this control on a Seam welder, the EXTENDED FUNCTIONS parameter for Seam mode should be set to [S.E.] = 00. If welding very thin gauges of material (20 Ga. or thinner), setup could be done without a coupon, wheel to wheel. If operating a Seam Welder, stop the motor which turns the wheels.