



MedWeld 3005

Resistance Weld Control



Operator's Guide
for Software Program #T93300

Revision 08
Modified: 3/17/06
Part No. M-032025

Table of Contents

<i>Getting Started</i>	<i>viii</i>
How to Get Help	viii
By Phone or Fax:	viii
By E-mail:	viii
On the Web:	viii
Symbols Used in This Manual	ix
Revision History	x
Safety Dangers	x
How To Use this Manual.....	xii
Software Updates	Xii
Acknowledgments	xii
Cooling Water Requirements	xiii
Water Flow Rate	xiii
Hoses	xiv
Working with Static-Sensitive Devices	xvi
Personnel Grounding	xvi
Handling or Moving ESDS Devices	xvi
Workstation Requirements	xvi
Contact Information	xvi
Copyright	xvi
Patents	xvi
<i>Chapter 1 MedWeld 3005 Overview</i>	<i>1-1</i>
System Description	1-1
Physical Description	1-2
Chassis	1-4
Allen-Bradley™ Power Supply	1-4
SLC-500 Processor	1-4
WTC Weld Processor	1-5
RIO Integration	1-8
RIO Network Module	1-8
DeviceNet Integration	1-8
DeviceNet Module	1-9

MODULE LED Status Indications	1-10
NET LED Status Indications	1-10
Numeric Status Codes	1-11
Combination Module	1-12
Discrete I/O Modules	1-13
Discrete Input Modules	1-13
Discrete Output Modules	1-14
Component Descriptions	1-15
Circuit Breaker	1-15
Isolation Contactor	1-16
Control Transformer	1-16
Current Coil	1-16
Firing Card	1-16
Cascade Firing Board	1-18
SCR Assembly	1-18
Secondary Current Interface Board	1-18
Available Configurations	1-19

Chapter 2 Installing the MedWeld 3005 2-1

Getting Started	2-1
Making the Required Connections	2-1
Remote Integration	2-4
Providing Local and Safety I/O	2-4
Setting the DIP Switches	2-4
Selecting the I/O Group	2-5
Selecting the Rack Size	2-5
Setting the Rack Address	2-6
Selecting the Last Rack	2-6
Setting the CLEAR ON FAULT Status	2-7
Setting the BRS (Bit Rate Select)	2-7
DeviceNet Integration	2-8
Discrete Integration	2-9
Providing MedLAN Connections	2-9
MedLAN and DEP-100S Connections	2-9
MedLAN Wiring Specifications	2-10
Cable Requirements	2-10
Cable Routing Requirements	2-11
Setting the Weld Processor MedLAN Address	2-13
Programming the Weld Processor	2-16
DEP-100S Programming Device	2-16
Welding Support System (XWSS)	2-17

Chapter 3 Communications and I/O 3-1

Local and Safety I/O	3-1
----------------------------	-----

Local Inputs	3-2
Local Outputs	3-3
Remote I/O	3-4
Organization of the DeviceNet I/O	3-4
Discrete Integration	3-5
I/O Definitions	3-5
Inputs	3-5
Outputs	3-10
DEP-100S Abbreviations	3-13
Input Abbreviations	3-14
Output Abbreviations	3-15
DIO Abbreviations	3-16
Discrete Inputs	3-16
Discrete Outputs	3-17
DEP-100S P2 (MDS-555-Style) Abbreviations	3-18
Inputs	3-18
Outputs	3-19

Chapter 4 *Weld Schedules* 4-1

What is a Weld Schedule?	4-1
Software Capabilities	4-2

List of Functions	4-4
Delay Functions	4-4
Weld Functions and Firing Modes	4-4
AVC Firing Mode (%I)	4-5
Automatic Current Compensation Firing Mode	4-6
Other Functions Controlling Weld Current	4-7
Output Control Functions	4-9
Input Monitoring Functions	4-10
Extend/Repeat Functions	4-12
Stepper Assignment Functions	4-13
Functions that Override Setup Parameters	4-14
Test Functions	4-14
Special Functions	4-18
SPC Indexing Functions	4-20
Cascade Firing Board Support	4-21
Analog Pressure Control Functions	4-22
Quick Reference	4-23
Delay Functions (pg. 4-4)	4-23

AVC Firing Mode (pg. 4-5)	4-23
ACC Firing Mode (pg. 4-6)	4-24
Other Functions Providing Weld Current (pg. 4-7)	4-24
Output Control Functions (pg. 4-9)	4-24
Input Monitoring Functions (pg. 4-10)	4-24
Extend/Repeat Functions (pg. 4-12)	4-25
Stepper Assignment Functions (pg. 4-13)	4-25
Functions that Override Setup Parameters (pg. 4-14)	4-25
Test Functions (pg. 4-14)	4-25
Special Functions (pg. 4-18)	4-25
SPC Index Functions (pg. 4-20)	4-25
CFB Support Functions (pg. 4-25)	4-25
Analog Pressure Control Functions (pg. 4-22)	4-26
Default Weld Schedules	4-26
Default Weld Sequence: Machine	4-26
Default Weld Sequence: Robot	4-26
Tip Dress Sequence #14	4-27
Tip Dress Sequence #15	4-27
Default Weld Sequence: Manual/Portable Gun	4-27

Chapter 5 *Advanced Software Features* 5-1

C-Factor	5-1
Example of Decreasing C-Factor	5-2
Example of Increasing C-Factor	5-2
Low C-Factor Limit	5-3
Determining a Low Limit:	5-3
High C-Factor Limit	5-3
Determining a High Limit	5-3
KVAT	5-4
Dynamic Current Windows	5-4
AVC Example	5-5
ACC Firing Mode	5-6
Dynamic Squeeze Features	5-7
Specifying the Test Fire Current	5-7
Defining the Current Threshold	5-7
Dynamic Squeeze Functions	5-8
SPC Indexing Capabilities	5-9
SPC Functions	5-9
SPC setup Parameters	5-10
SCR Short Detection	5-11
Retract Features	5-13
Retract Mode Setup Parameter	5-13
Cylinder Type	5-14
Air-Only Cylinders:	5-14
Initiation From Retract	5-15

<i>Chapter 6</i>	<i>Setup Parameters</i>	<i>6-1</i>
	Parameter Descriptions	6-2
	Analog Pressure Control	6-15
	Quick Reference to Setup Parameters	6-16
<i>Chapter 7</i>	<i>Stepper Data</i>	<i>7-1</i>
	What is a Stepper?	7-1
	Linear Steppers	7-2
	Default Linear Stepper Profile	7-3
	Display at the DEP-100S	7-3
	SureWeld Steppers	7-4
	SureWeld Parameters	7-5
	Display at the DEP-100S	7-7
<i>Chapter 8</i>	<i>Fault Conditions</i>	<i>8-1</i>
<i>Chapter 9</i>	<i>Hardware Troubleshooting</i>	<i>9-1</i>
	Power Supply	9-1
	SLC Processor	9-2
	Weld Processor	9-4
	RIO Network Module	9-6
	Combination I/O:	9-7
	Input Module	9-7
	Output Module	9-9
	Solving Typical Problems	9-10
<i>Application Note:</i>	<i>Cascade Welding</i>	<i>App-1</i>
	Scope	App-1
	Cascade Welding Information for AC Products	App-1
	Background Information	App-1
	Parallel Cascade Method	App-1
	Multiple Output Method	App-2
	The Differences Between Method 1 and Method 2	App-3
	Weld Schedules in Cascade Welds	App-3

<i>Appendix: I/O Image Tables</i>	<i>A-1</i>
RIO Image Tables	A-1
Host PLC Output Image Table (Welder Inputs):	A-1
Host PLC Input Image Table (Welder Outputs)	A-3
RIO_2 Host PLC Output Image Table (Welder Inputs):	A-5
RIO_2 Host PLC Input Image Table (Welder Outputs)	A-7
RIO_3 Host PLC Output Image Table (Welder Inputs):	A-9
RIO_3 Host PLC Input Image Table (Welder Outputs)	A-11
RIO_4 Host PLC Output Image Table (Welder Inputs):	A-13
RIO_4 Host PLC Input Image Table (Welder Outputs)	A-15
RIO_5 Host PLC Output Image Table (Welder Inputs):	A-17
RIO_5 Host PLC Input Image Table (Welder Outputs)	A-19
DeviceNet I/O Tables	A-21
dnet_map Welder Inputs—Node 30	A-21
dnet_map Welder Outputs—Node 30	A-22
dnet_map Welder Inputs—Node 30	A-23
dnet_map Welder Outputs—Node 30	A-24
dnet1_map Welder Inputs—Node 30	A-25
dnet1_map Welder Outputs—Node 30	A-27

Getting Started

If You Need Help . . .

.

Welding Technology Corp. (WTC)

WTC is committed to quality products, service and support. Our service department maintains an assistance hotline to assist with application or troubleshooting during normal business hours.

By Phone or Fax:

To arrange for field service, call one of these numbers:

Industrial Technical Service (ITS) Voice: (248) 477-3900
Fax: (248) 477-8897

The ITS telephone number offers 24-hour service, seven days a week. Before calling, make a note of any fault conditions, applicable software and hardware revision numbers. Record the part number of the enclosure (on the serial tag on the inside or front door of the enclosure). Also note the sequence of events leading to the problem, and the drawing numbers of the schematics you received with the enclosure. For your convenience, fill out the “Problem Report Form” on page -xviii.

By E-mail:

When an immediate response is not critical, contact WTC at the following e-mail addresses:

welding-sales@weldtechcorp.com Sales/Marketing Comments
welding-support@weldtechcorp.com Technical Support

WTC’s technical support will respond within 24 hours, Monday through Friday, to your e-mail requests. Please include your name, company name, location, product part and serial number and a description of the problem with your request. Be sure to indicate how you want us to respond, and include applicable phone and fax numbers with your e-mail address.

On the Web:

Visit our Web site at: www.weldtechcorp.com.

Symbols Used in This Manual

• • • • • • • • • •

Danger! and **WARNING!** messages indicate high-voltage hazards in weld controls, SCRs, MFDC inverters and weld monitoring equipment.

Danger!



This symbol will be used wherever failure to observe safety measures may result in death, severe bodily injury or serious damage to property.

WARNING!



This symbol will be used wherever insufficient or lacking compliance with instructions may result in personal injury.

Caution: and **NOTE:** messages indicate the following:



Caution:

This symbol denotes when insufficient or lacking compliance with the instructions may damage equipment or files.

NOTE:

This convention informs the user about special features, or where to find more information.

Revision History

• • • • • • • • • •

Revision	Release Date	Comments
2	09/04/98	Released to support T93300-16
3	07/29/99	Released to support T93300-17 Added Cascade support. Added Welding Schedule Function #11 Added weld data, fault data and limit checks for individual contactors in cascade mode. Removed stepper Status on/off toggle.
4	06/07/00	Released to support T93300-18 Added 2 I/O scan + 1 cycle delay in turn on contactor select function 11. If set to alert: Weld Schedule Fn70, 68 & 65 if fail will still attempt to weld. If set to fault: Weld Schedule Fn72 if fail will inhibit welding.
5	06/30/00	Released to support T93300-19 Added pressure control. Added Welding Schedule Fn8, 9, 13, 14. Added Setup Pressure not achieved fault, Valve #1 & Valve #2 initial pressure. Enabled DEP pressure control screen.
6	01/29/02	Released to support T93300-20 Added Secondary Current Monitoring. Added Setup Secondary Current Coil/Board fault, Current Monitor Mode, & Secondary Current Coil Factor.
7	08/27/03	Updated “getting started” section of manual.

Safety Dangers

• • • • • • • • • •

Danger!



**FAILURE TO OBSERVE SAFETY MEASURES
MAY RESULT IN DEATH, SEVERE BODILY
INJURY OR SERIOUS DAMAGE TO PROPERTY.**

Danger!



LETHAL voltages are present when applying power to the weld control. Exposure to high voltage WILL CAUSE SEVERE ELECTRICAL BURNS, INTERNAL INJURIES and/or DEATH.

Refer all necessary service on this machine ONLY to qualified maintenance personnel.

Danger!



NEVER drill into the control cabinet without properly protecting internal components from metal debris and removing power. Failure to observe this requirement may cause a potential EXPLOSION HAZARD.

Danger!



Always ensure proper flow rate, temperature and chemistry of cooling water. Obstructed or insufficient flow of cooling water may damage welding transformers, SCRs or MFDC inverters. Refer to “Cooling Water Requirements” on page -xiii for more details.

Danger!



NEVER remove circuit boards with 110 VAC (or higher voltage) power applied. Be certain to REMOVE POWER BEFORE servicing, installing or removing circuit boards.



Caution:

When lifting any weight over 20 kg (~45 lb.), use either a two-man lift or an assisted lift.

How to Use this Manual

.

This manual is designed as a reference guide. Use it as you would a dictionary. See the Table of Contents to locate the instructions or information you require. For additional details, you are referred to the appropriate sections and page numbers.

The Table of Contents lists each section and subsection. In these sections, descriptive subheadings indicate the information provided. Simply flip to the page number and subheading indicated.

Detailed procedures describe the steps required to perform each programming task. Other descriptions explain the procedures for installation, initialization and troubleshooting, along with explanations of the hardware and each weld function.

Software Updates

.

WTC reserves the right to make substitutions or changes as required to the hardware or software described in this manual.

This manual may be periodically updated to reflect software changes that will affect operation of the equipment described. Request copies of the latest updates by completing the “Comments for Feedback Form” on page -xx, or by visiting WTC’s Web site: www.weldtechcorp.com.

Acknowledgements

.

MedLAN is the proprietary local area network used to interconnect products manufactured by WTC.

The Following companies own the marks following their names:

Allen Bradley, SLC™

Microsoft, Windows™

Cooling Water Requirements

.

Specifications on the Web

The specifications for cooling water are subject to change. For the latest specifications, go to the WTC Web site:
<http://www.weldtechcorp.com/documentation/index.html>.

Cooling Water Specifications

The cooling water provided must comply with chemical and physical specifications as stated in the Resistance Welder Manufacturers' Association **Bulletin 5-005.05**:

- Maximum temperature not to exceed 104° F. (40° C.), or fall below the dew point of ambient air at about 70° F. (21° C.).
- Maximum pressure not to exceed 90 PSIG
- pH maintained between 7.0 and 8.0
- Maximum chloride content 20 parts per million (PPM)
- Maximum nitrate content 10 PPM
- Maximum sulfate content 100 PPM
- Maximum suspended solids content 100 PPM, non-abrasive
- Maximum total (suspended and dissolved) solids content 250 PPM
- Maximum calcium carbonate content 250 PPM
- Resistivity less than 2,000 ohms/cm at 25° C. (500 µS)
- The hose used must be NO LESS THAN 18 in. long across the power voltages.

NOTE:

Water that is safe for drinking is generally sufficient for cooling water, provided it is filtered to eliminate sand and rust particles. In addition, water temperature must NOT fall more than 2° C. below the temperature of the surrounding air.

Water Flow Rate

In general, the SCRs require a MINIMUM flow rate of 0.5 gallon (2 liters) per minute. The recommended maximum is 1.0 gal (4 l.) per minute. Larger SCRs (2,100 A. or greater) may require a higher flow rate. Consult WTC for more information.

SCRs with Hose Running Between Tangs at 480 VAC.

The following warning applies **ONLY** to SCRs which have the water cooling hose running between tangs at 480 VAC (non-isolated).

WARNING!



REMOVE POWER from the SCR if the cooling water is not flowing and the resistivity of the water is less than 2,000 ohms/cm @ 25° C, or conductivity is greater than 500 μ Siemens @ 25° C.

If water circulation (in hosing between tangs) stops or is interrupted while the power is on, leakage current through the water in the hose between the SCR tangs will cause gas bubbles to form. Current will arc across these voids, weakening or destroying the hose. Putting the water into circulation again develops pressure in the cooling circuit, consequently causing the hose to rupture. *Therefore, WTC does NOT recommend the use of water savers with these SCRs.*

When magnetic contactors are used, they remove power from the SCR module and prevent destruction of the hose. If cooling manifolds are used (rather than hose), leakage current in the water can cause the same destructive action to occur while power is being applied. This can destroy the cement holding the manifold together, resulting in serious water leaks. (WTC's warranty specifically EXCLUDES such failures.)

Hoses

If a cooling hose (for non-isolated SCRs) needs replacing, use a certified non-electrically conductive hose. Its inside diameter must NOT exceed 3/8". The hose between SCR tangs must be *at least* 18 inches long across the power voltages, where the SCR tangs are directly cooled.

Working with Static-Sensitive Devices

.

ESD Costs!

Electrostatic discharge (ESD) can ignite flammable materials and damage electronic components. Static electricity can attract contaminants in clean environments or cause products to stick together. Other costs of ESD-damaged electronic devices are in their replacement and production down time. Associated costs of repair and rework, shipping, labor and overhead can be significant. Reducing losses to ESD and static electricity is an ABSOLUTE NECESSITY.

Observe the following warnings AT ALL TIMES:

Danger!



NEVER use the personnel grounding system described below when working with voltages above 220 VAC.

Personnel Grounding

Before touching any Electrostatic Discharge Sensitive (ESDS) devices or circuit boards, put on and wear an Electrostatic Discharge (ESD) wrist strap. Ground this strap through a one megohm (1 MΩ) resistor.

Handling or Moving ESDS Devices

Handle all circuit boards by their edges ONLY. NEVER touch the traces or edge pad connectors.

Transport, store and ship ESDS devices and circuit boards in a static shielding container. An acceptable container is either a static shielding bag or a static shielding tote. To be effective, either type of container MUST be closed.

NOTE:

Use ONLY static-shielding containers for transporting ESDS devices or circuit boards.

Workstation Requirements

If diagnostics are required, move the circuit board to an approved ESD workstation. A static-safe workstation must include a grounded ESD mat, wrist strap and cord. The measured static voltage at a workstation MUST NOT exceed 50 volts.

Contact Information

For detailed information about ESD precautions, contact

ESD Association

Voice: 315-339-6937

Fax: 315-339-6793

Web: www.esda.org

e-mail: info@esda.org

Copyright

.

WTC software and publications are copyrighted and all rights are reserved by WTC. Distribution and sale of software is intended for the use of the original purchaser, and only for use on a single machine.

Copying, duplicating, selling or otherwise distributing this software is a violation of law.

WTC specifically does not authorize duplication of the software stored in the EEPROM, distribution media (magnetic or CD-ROM) or in print form, without prior written authorization and payment of royalty fees.

Patents

.

This product contains intellectual property owned or licensed by WTC, including (but not limited to) one or more of the following U. S. patents:

4,388,515	4,399,511	4,459,456	4,459,457	4,463,244	4,973,815
4,493,040	4,513,363	4,516,008	4,721,840	4,733,045	6,130,396
4,804,819	4,831,229	4,849,873	4,851,635	4,885,451	6,215,086
4,973,419	4,945,201	5,128,507	5,276,308	5,347,105	6,225,590
5,386,096	5,424,506	5,440,092	5,449,887	5,471,028	6,342,686
5,483,035	5,589,088	5,667,704	5,757,176	5,793,243	6,359,566

Other patents, U. S. or foreign, may be issued or pending.

The software and documentation associated with this product are protected by copyrights owned by WTC. Trademarks have been adopted and used on all or part of this product.

This page is intentionally left blank.

Problem Report Form

.

Plant Name and Location: _____

Phone: _____

Your Name: _____ **Date:** _____

Time: _____

Program # (Timer power-up message): _____ - ____ - ____ ____/____/____

Part #: _____

Fault code display. When a fault or error occurs, the Product ### displays a status code. Indicate each code that is displayed:

Description of the problem: _____

Sequence of events leading to the problem: _____

Drawing number(s) of schematic(s) shipped with the Product ###:

This page is intentionally left blank.

This page is intentionally left blank.

MedWeld 3005 Overview

1

The MedWeld 3005 welding control represents a new phase in resistance welding technology. The unit integrates a weld control with a programmable controller located in the weld control enclosure.

The card rack design allows the control to communicate with the welding automation: either machine controllers, factory automation or manually operated welders. (The type of integration is determined by the ladder software program loaded into the SLC processor.)

System Description

• • • • • • • • • •

The MedWeld 3005 weld control sits as a combination of modules mounted in the controller chassis for an Allen-Bradley™ SLC-500 Programmable Controller. A weld processor sends firing signals to its firing card through a firing cable harness plugged directly into the weld processor card.

This modular design allows use in a number of applications. Two forms of integration are possible:

- *Discrete interface (DIO)*, where the weld control can exchange I/O with a machine, robot or portable gun controller. The control communicates using inputs from the automation and outputs to the automation.
- *A remote I/O (RIO) interface*, providing a direct link to the Allen-Bradley RIO network in a host PLC. This scheme allows the weld processor to emulate a logical quarter-rack on an Allen-Bradley RIO bus, where standard remote I/O is shared by the weld control and PLC.
- *The DeviceNet™ interface*. This open communications standard provides a low-cost communications link with I/O messaging between the welding control and tool.

With the RIO interface, the rack contains an RIO network module. In addition, a combination I/O module provides discrete (local) inputs and outputs for safety interlocks. See “RIO Integration” on page 1-8.

The DeviceNet interface also requires a module in the control rack and uses the Combination I/O module to provide discrete (local) inputs and outputs for safety interlocks. This is described in “DeviceNet Integration” on page 1-8.

When the control uses a discrete interface, the rack contains an input module and an output module, described in “Discrete I/O Modules” on page 1-13.

These advanced integration options add flexibility to the WTC design, providing full-function and programming capabilities. You can program up to 99 independent weld schedules, then assign a weld schedule to one of 99 independent steppers (to compensate for lost current density). Note older programs only allow 31 welding schedules and 31 steppers.

The control compensates for changes in the welding environment by monitoring the voltage and increasing the current as required to assure consistent welds. The primary current (I) changes as the voltage fluctuates.

You can program a weld function to use either Automatic Voltage Compensation (to maintain a desired primary voltage) or Automatic Current Compensation (to maintain constant secondary current).

The MedWeld 3005 can perform the weld, delay, slope, pulsation or timing functions that your application requires. Other features allow control of outputs, and monitor the status of inputs.

Physical Description

.

The MedWeld 3005 weld processor consists primarily of two printed circuit boards: The weld processor and the firing card. The weld processor is mounted in the chassis of an Allen-Bradley programmable controller, to support the integration options.

Figure 1 on the facing page illustrates the weld control.

Figure 1: MedWeld 3005 Weld Control

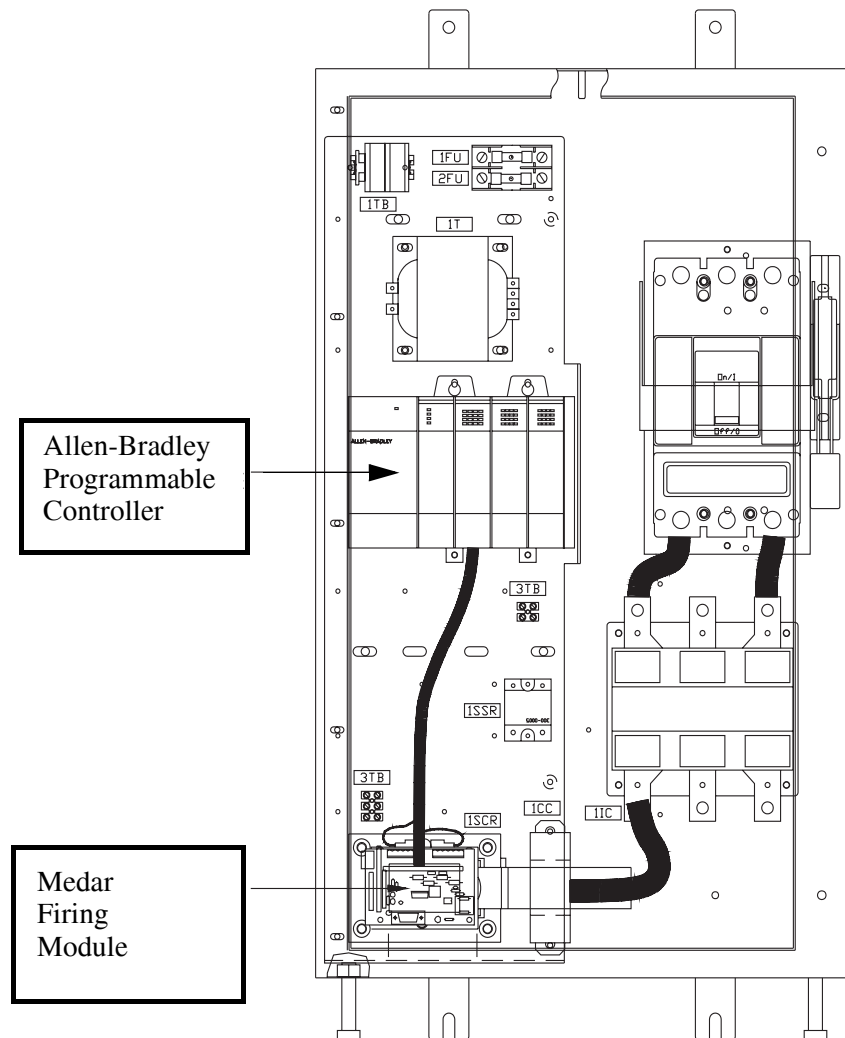

The Allen-Bradley chassis houses these major components:

- Allen-Bradley power supply, mounted on the left side of the chassis. (See Figure 2 on page 1-4.)
- SLC-500 processor (Figure 3 on page 1-4)
- MedWeld 3005 weld processor (Figure 4 on page 1-6)
- Communications modules (for RIO, DeviceNet or DIO).

The following sections describe these components.

Chassis

A 4-slot chassis mounts the SLC processor, WTC weld processor and two interface modules. (The latter can be *either* RIO Network and local modules *or* the DIO input and output modules.)

Figure 2: Allen-Bradley 4-Slot Chassis with Power Supply

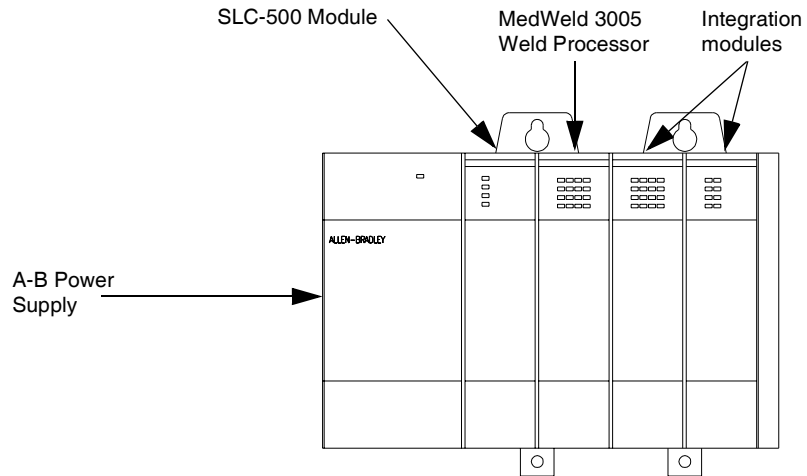

Allen-Bradley™ Power Supply

The power supply provides power to the Allen-Bradley programmable controller. It also supplies the power needed for I/O communications and external programming devices.

NOTE:

The power supply DOES NOT occupy a slot in the chassis. It mounts on the left side with two Phillips-head screws located in the top and bottom right corners, under the faceplate.

SLC-500 Processor

The Allen-Bradley SLC-500 processor provides the interface between the MedWeld 3005 processor module and any automation system or welding station.

(Refer to “Available Configurations” on page 1-19, and the integration options described in “RIO Integration” on page 1-8 and “Discrete I/O Modules” on page 1-13.)

Figure 3: Allen-Bradley SLC-500 Processor

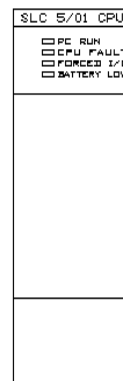

On the processor module are several LEDs (light-emitting diodes). They indicate the status of the processor. These are the status indications:

PC RUN *On steadily:* The SLC processor is in Run mode.

CPU FAULT *Flashing at power up:* The processor has not been configured.

Flashing during operation: The processor detected a major error either in the SLC processor, another card in the rack or in memory.

On steadily: This indicates any loss of communications.

FORCED I/O *Flashing during operation:* One or more input or output addresses have been forced to an ON or OFF state, but the forced ON or OFF is not enabled.

On steadily: Indicates the forced ON or OFF state is enabled.

BATTERY LOW *On (steadily):* Indicates the battery voltage has fallen below a threshold level, or the battery and the jumper are missing.



Caution:

Forced I/O is a programming/debugging tool. During normal operation, the control should NOT be functioning with forced I/O.

WTC Weld Processor

The weld processor provides a firing signal to the firing card, as required by the weld schedule. The firing card then provides the single-phase gate signals to the SCRs, which then send welding voltage to the weld transformer to apply weld current to the work piece.

The weld processor module provides three connectors for system communications; the Programming port, the MedLAN port and the WTC firing card interface port.

Programming port (top): Use this connector to plug a programming device directly into the WTC weld processor card.

- Connect a **DEP-100S** Data Entry Panel to the Programming port to program the control's basic operating parameters and set its network address.

- MedLAN port (middle). Use this connector to link the weld control to other controls and a network monitoring system through the WTC Local Area Network (**MedLAN**).
- Firing Card port (bottom). Use this connector to link the weld processor board to the WTC firing card.

These three connectors are shown in Figure 4 below:

Figure 4: WTC 3005 Weld Processor

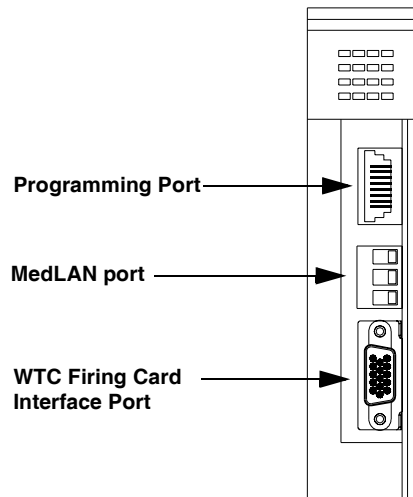

The weld processor performs the following weld timing functions required to execute a weld schedule:

- Checks input signals (provided through the SLC processor) from the I/O modules (either remote or discrete) and reacts to them accordingly.
- Operates the output signals (through the SLC processor) based on the weld schedule.
- Sends single-phase firing signals to the firing card as required by the weld schedule.
- Receives sense signals for line voltage, current and power factor from the firing card.
- Adjusts the firing signal, based on the power factor and the line voltage or primary current, based on how the weld schedule is programmed.

LED indicators on the weld processor module show control status. These indicators are described below:

PWR	This LED lights to indicate that the weld processor is receiving power and is functioning normally.
F.C.	These LEDs light to indicate that the weld processor card has sent the logic level firing signal to the firing card. These lights are normally off and should only turn <i>on</i> when current is provided by the weld schedule.
MedLAN	These two LEDs light to show that communication is occurring on the MedLAN channel.
DEP	These LEDs light to indicate that communication is taking place between the data entry panel (DEP) and the weld processor card.
RTW	This LED lights when the control is ready to weld. It indicates that the control will provide current under the following conditions: <ul style="list-style-type: none"> • No faults exist • The CONTROL STOP input is not active (off is active) • The control is in Weld Mode • The WCU is synchronized with the welding bus • The SCR OVER TEMPERATURE input is closed, or • The TRANSFORMER OVER TEMP input is closed.
IACK	This LED lights when the control starts executing a weld schedule. It turns off when the control completes weld schedule.
NWLD	This LED lights when the control is in No Weld Mode.
BATT	This LED lights when the battery on the weld processor card is low.
FLT	This LED lights when the processor detects a condition you defined as a Fault in the setup parameters.
PROC	This LED lights to indicate that the weld processor detected either a RAM Failure, a shorted contactor or an SLC I/O failure.

RIO Integration

When configured to use RIO integration, the MedWeld 3005 control has two modules in the card rack: The RIO module and the Combination module for local control of critical safety I/O.

RIO Network Module

The RIO Network module exchanges serial I/O data between the control and a host located outside of the weld control enclosure.

To install the RIO Network module, you must correctly position several DIP switches located on the module's printed circuit board. These switches enable the module to correctly interpret the system configuration and addressing. Refer to the procedure described in "Setting the DIP Switches" on page 2-4.

The RIO Network module also provides LED indicators to show the status of communications on the network, as described next.

Figure 5: RIO Network Card

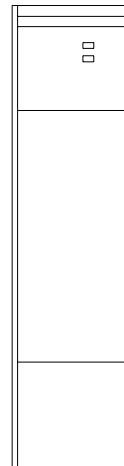

FAULT This LED lights to indicate that an internal fault was detected.

COMM This LED is normally on. It turns OFF to indicate that communication with the host has failed.

DeviceNet Integration

When the control provides DeviceNet integration, the SLC rack requires two additional modules: The DeviceNet module and the combination module (for local control of certain critical I/O).

With this integration scheme, a network of DeviceNet devices allows for rapid communications between industrial devices. The DeviceNet module communicates with the SLC controller to provide information from the welding environment to the weld processor.

DeviceNet communications protocol is an open network standard, maintained by the Open DeviceNet Vendor Association (ODVA). The DeviceNet protocol allows for peer-to-peer data (where any product can produce or consume messages and the DeviceNet product can behave as Client, Server or both). The network can have up to 64 node addresses. Each node supports an infinite number of I/O.

NOTE: *For more information on DeviceNet, contact your WTC representative.*

DeviceNet Module

The DeviceNet module is shown below:

Figure 6: DeviceNet module

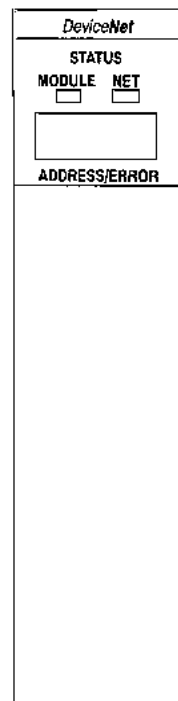

This module provides two bi-color status indicators. In addition, a numeric code display area provides diagnostic information.

MODULE LED Status Indications

The status indicator labeled MODULE uses two colors (green and red) and a flashing state to show the operating status of the DeviceNet module.

Color	Description	Remedy
Off	There is no power applied to the module.	Apply power.
Green	The module is in normal operating condition.	None
Flashing Green	The module is not configured.	Configure the module.
Flashing Red	The configuration is invalid.	Check the configuration setup.
Red	The module has an unrecoverable fault.	Replace the module.

NET LED Status Indications

The NET indicator provides troubleshooting information for the DeviceNet channel communications, as shown below:

Color	Explanation	Which Indicates:	Remedy:
Off	The device has no power or the channel is disabled for communication.	The channel is disabled for DeviceNet communications.	Power up the module, provide network power and verify that the channel is enabled in both the module configuration table and the module command word.
Green (Flashing)	The 2-digit numeric display shows an error code with more information.	The channel is enabled but there is no communication.	Configure the Scan List table for the channel to add devices.
Green	Normal operation.	All slave devices in the Scan List table are communicating with the module.	None
Red	The communications channel has failed. The 2-digit numeric display shows an error code with more information.	The module may be defective.	Reset the module. If the failures continue, replace the module.
Red (Flash)	The 2-digit numeric display for the channel displays an error code with more information.	At least one slave device in the module's Scan List has failed to communicate with the module.	Examine the failed device and the Scan List table for accuracy.

Numeric Status Codes

The numeric display (below the two bi-color indicators) also provides diagnostic information about the status of the module. The display flashes at 1-second intervals.

The table below summarizes the meanings of the numeric codes:

Code	Description	Remedy
Network Address Displays 0–63	Normal operation. The numeric display matches the scanner's node address on the DeviceNet network.	None.
70	Module failed Duplicate Node Address check. The node address you selected is already in use on that channel.	Change the module channel address to another available address.
71	Illegal data in Scan List table (node number alternately flashes).	Re-configure the Scan List table and remove any illegal data.
72	Slave device stopped communicating (node number alternately flashes).	Inspect the field devices and verify the connections.
73	Device ID does not match Scan List table entry (node number alternately flashes).	Enter a matching Scan List device ID.
74	Data overrun on port detected.	Modify your configuration and check for invalid data.
75	No network traffic has been detected.	Verify connections.
76	No direct network traffic for module detected.	None. The module hears other network communication.
77	Data size returned does not match Scan List's entry (node number alternately flashes).	Reconfigure your module and change the addressing.
78	Slave device in Scan List table does not exist (node number alternately flashes).	Add the device to the network, or delete the Scan List entry for that device.
79	Module has failed to transmit a message.	Make sure your module is connected to a valid network. Check for bad cable connections or disconnected cables.
80	Module is in IDLE mode.	None.
81	Module is in FAULT mode.	None.
82	Error detected in sequence of fragmented I/O messages from device (node number alternately flashes).	Check Scan List entry table for slave device to make sure that input and output data lengths are correct. Check slave device configuration.

Code	Description	Remedy
83	Slave device is returning error responses when module attempts to communicate with it (node number alternately flashes).	Check accuracy of Scan List table entry. Check slave device configuration.
84	Module is initializing the DeviceNet channel.	None. This code clears itself once the module attempts to initialize all slave devices on the channel.
85	Data size returned is bigger than expected.	Check accuracy of Scan List table entry. Check slave device configuration.
88	Not an error. At power-up and reset, the module displays all 14 segments of these LEDs.	None.
90	User has disabled the communications port.	Reconfigure your module.
91	Bus-off condition detected on the communications port. Module is detecting communication errors.	Check the DeviceNet connections and physical media integrity. Check system for failed slave devices or other possible sources of network interference.
92	No network power detected on communications port.	Provide network power. Make sure that module drop cable is providing network power to module communications port.
95	Application FLASH update in progress.	None. Do not disconnect the module while application FLASH in progress. You will lose any existing data in the module's memory.
97	Module halted by user command.	None.
98	Unrecoverable firmware failure.	Service or replace module.
99	Unrecoverable hardware failure.	Service or replace module.

The image table used by the DeviceNet module is provided in “DeviceNet I/O Tables” on page -21.

Combination Module

The combination module is used to provide *additional* discrete (local) inputs and outputs for *either* remote I/O or for DeviceNet integration. These inputs and outputs are provided to allow for direct control of critical local and safety interlocks.

Descriptions of the I/O provided by this module appear in “Local and Safety I/O” on page 3-1.

Figure 7: Combination I/O Module

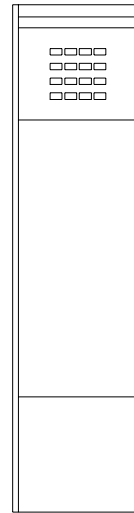

Discrete I/O Modules

When configured to use the discrete I/O integration scheme, the MedWeld 3005 uses an input module and an output module to replace the RIO Network and Combination modules.

These modules can provide either 8 or 16 connections, depending on your application requirements. In either case, the face of the module provides the appropriate number of LEDs to indicate the status of each input or output.

Discrete Input Modules

The input module allows the weld control enclosure to *receive* 8 or 16 discrete inputs from a welding machine, robot or portable gun controller. To access these I/O points, wire the inputs from the devices into the modules.

Refer to the drawing packet provided with your control for a complete list of the I/O used in your application, as well as a definition of the I/O voltage and voltage source used in your application.

Chapter 3 lists the available discrete I/O signals for a MedWeld 3005 control on page 3-5. Abbreviations that the DEP-100 uses to display the status of the inputs appear on page 3-13.

Figure 8: Input Module Options

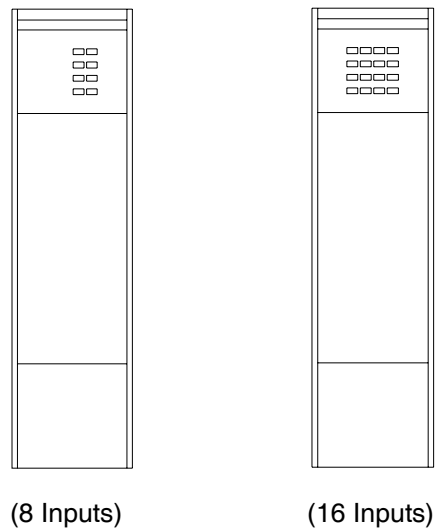

Discrete Output Modules

The output module allows the weld control enclosure to *send* 8 or 16 signals to a machine, robot or portable gun controller.

Again, wire from the output module to the external devices. Refer to the drawing packet provided with your control for a complete list of the outputs used in your application, and the definition of the I/O voltage and voltage source used in your application.

The complete list of discrete outputs available for the MedWeld 3005 appears on page 3-5.

Figure 9: Output Module Options

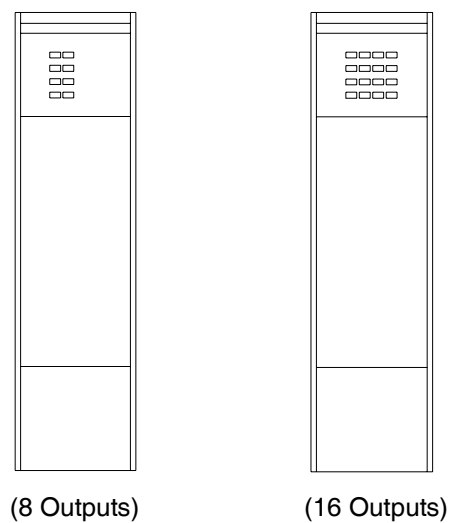

Component Descriptions

• • • • • • • • • •

This section is a brief description of the following components provided with the MedWeld 3005 control (AC type):

- Circuit breaker
- Isolation contactor
- Control transformer
- Current coil
- Timer assembly
- Discrete I/O board (optional)
- Firing card
- Cascade Firing Board (optional)
- SCR assembly
- Secondary Current Interface Board (optional).

Circuit Breaker

A circuit breaker provides the means to safely disconnect power from the control in case of a failure, and permits troubleshooting the control safely. Incoming power enters the control enclosure through the access plates at the top right of the cabinet.

The standard control configuration uses a 400 A. circuit breaker. Ratings of 250 A. or 600 A. and higher are optional.

The supply voltage (380, 480 or 600 VAC) is connected to the single-pack breaker at terminals located at the top of the breaker. Refer to “Installation Checklist” on page 2-26 for more information.

An operator handle (on the outside of the cabinet) operates the circuit breaker, and visually indicates its condition. The handle must be UP to turn ON the breaker. The handle must be DOWN to turn the breaker OFF. The middle position indicates that the breaker has tripped.

An operator mechanism interlocks the door with the circuit breaker’s status. This mechanism permits turning on the circuit breaker ONLY when the door is closed. Turning the breaker OFF permits opening the door, as a safety feature while servicing the control.

The circuit breaker has a magnetic trip coil and a dial or DIP switches to adjust the level of current the breaker trips at. The magnetic trip coil trips the breaker if instantaneous current reaches or exceeds a pre-set current threshold level.

As supplied from the circuit breaker's manufacturer, the magnetic trip coil is set to its minimum setting. The customer must adjust this setting as the application requires. It is **CRITICAL** to set this threshold correctly, for these reasons:

- Setting the magnetic trip to a too-high value can cause the upstream bus fuse to blow before the circuit breaker trips in response to an overload. This means that the fuse needs to be replaced (a time-consuming job) rather than simply resetting the circuit breaker. This is a convenience issue, not a safety issue.
- Setting the magnetic trip setting too low may cause the circuit breaker to trip under normal welding currents (even if there is no overcurrent fault). This is a nuisance issue, not a safety issue.

Isolation Contactor

The isolation contactor acts to isolate voltage from the weld transformer. It removes power from this transformer's primary circuit. This allows safely servicing the weld electrode tips or weld machine while the control is idle (or when a fault occurs). The timer monitors the state of the isolation contactor via the auxiliary contacts.

The isolation contactor is driven by a single solid-state relay, based on the status of the CONTROL STOP and WELD/NO WELD inputs, and a TURN ON function. Refer to page 4-8 for more information about these functions. Also, refer to the drawing packet of schematics provided with your MedWeld 3005.

Control Transformer

Supply voltage (380, 480 or 600 VAC) from below the circuit breaker goes to a control transformer. It reduces the supply voltage to 120 VAC, and 24 VAC. The 120 VAC is used to pull in the isolation contactor, and to activate the circuit breaker shunt trip. This transformer supplies 24 VAC to power the timer assembly. The timer assembly, in turn, provides optional 24 VDC that can power discrete inputs and outputs.

Current Coils

The standard MedWeld3005 has a coil to measure primary current. An optional coil measures secondary current.

The primary current coil is the doughnut-shaped device located near the SCR assembly in the control enclosure. It has an iron core. The control uses this device to measure the welder's primary current. Welding current flows through the center of the coil, inducing a current in the coil at the ratio of 200:1. (For example, for every 1,000 A. of primary current, 5 A. flows in the secondary.)

The optional secondary current coil has an air core. It produces current which is proportional to the secondary current's instantaneous rate of change. A Secondary Current Interface Board (Page 1-18) takes this information and determines true current values.

Firing Card

The firing card performs the following tasks:

- Provides sense signals to the processor to provide voltage, current and power factor reading, as well as properly regulating the SCRs,
- Provides gate signals to turn on the SCRs,
- Inputs and outputs all of the control's current monitoring and
- Performs high-voltage sensing.

Firing Card Input Signals

The wires connected to the firing card connector J3 (1L1 and 1L2 *without* an isolation contactor, or 1L1, 1L2 and 2L2 *with* an isolation contactor) originate across the 380/480/600 VAC supply voltage. These wires carry the zero-crossing logic signal. This signal synchronizes the weld processor with the supply.

They also provide the voltage-to-frequency logic signal that the weld processor card uses to measure line voltage.

The current coil generates a voltage signal which is proportional to the measured current. This signal enters the firing card *via* connector J4. The signal is converted to the current-to-frequency logic signal, which the weld processor board uses to measure the welder's current.

The firing card receives a logic-level firing signal through its J2 connector from the weld processor card. This signal is optically coupled to a high-voltage circuit on the firing card, and controls the SCR wired through the firing card connector J1.

Firing Card Output Signals

The firing card also outputs a group of logic level signals from the various connections at the welder's primary circuit. The weld processor uses these signals to:

- Find the zero-degree phase angle point on the supply power as a reference for its phase-angle measurements
- Measure the line voltage, current and power factor
- Adjust the firing phase angle, based on the voltage or current (depending on the firing mode) and the power factor and
- Check for shorted or misfiring SCR(s).

All of these signals are transmitted over firing card connector J2 and weld processor card connector J3.

Cascade Firing Board

The MedWeld 3005 can switch multiple contactors with one weld timer, a firing board and a system of relays. The *Cascade Firing Board* (CFB) implements this capability.

The CFB controls a system of three relays. They switch the gate lead connections between each firing board and three SCR pairs. This “pass-through” configuration of relays prevents the possibility of firing more than one SCR at a time (which can cause catastrophic failure).

The CFB is the same size as a 645 firing board, and uses the same mounting centers. The interface has four connectors to receive inputs to the SCR gate leads. Three output signal connectors go to the SCR gate leads. Three red LEDs indicate activation (if any) of its respective SCR.

Depending on which version is ordered, the CFB operates on either 120 VAC or 24 VDC.

SCR Assembly

When the SCR signal is gated in a single-pack configuration, power is passed to the weld transformer through connector H1. (Refer to the drawings supplied with your control for more information.)

Single-pack controls use a pair of SCRs. The unit has internal water cooling to minimize the external water connections.

Secondary Current Interface Board

This section describes the Secondary Current Interface Board (abbreviated to SCIB). The SCIB is an add-on accessory to kernel-based welding controls (i. e., MedWeld 3005,4000, T2200, 200, etc.). The SCIB enables the welding control to read secondary current.

The SCIB installs in-line on the cable which connects between the weld timer and the firing board. The form factor of the SCIB includes mounting holes which match those on the firing board.

The SCIB uses an air-wound (Rowgowski) current-sensing coil to measure secondary welding current. This sensing coil connects to the SCIB via a 2-pin Phoenix connector.

The SCIB is designed for use with air-core current sensing coils which meet the IEC standard of 150 mV output per kA with a sinusoidal 50 Hz current waveform (0.477 μ Hy mutual inductance). On 60 Hz, these coils output 180 mV per kA. To allow for variance in current-sensing coils, the welding control has a setup parameter to allow setting the mutual inductance between 0.05 and 0.99 μ Hy. The SCIB secondary current coil input terminals present a 1,000-ohm load to the coil. For more details on programming this parameter, see page 6-14.

The SCIB can measure AC or DC currents up to 100,000 A. For AC currents greater than 25% of full-scale, the measurement uncertainty of the SCIB itself is 1% of reading, plus the measurement uncertainty of the current-sensing coil.

For DC currents greater than 25% of full-scale, of less than 0.5 sec duration, the measurement uncertainty of the SCIB itself is 2% of reading, plus the measurement uncertainty of the current-sensing coil. Once installed and with self-calibration at recommended intervals, repeatability of the current reading from the SCIB is within +1 %.

The SCIB has three current ranges which are set with suitcase-type jumpers on the circuit board. These ranges are 0–25 kA., 0–50 kA. and 0–100 kA. Higher currents, up to any desired value, can be obtained by using a special jumper setting together with an external resistor network on the current-sensing coils.

Available Configurations

.

In addition to multiple integration options, the MedWeld 3005 can be configured in single-pack, tri-pack, six-pack or even 12-pack enclosures.

As previously described, the MedWeld 3005 supports RIO integration, DeviceNet, discrete I/O and serial I/O integration.

NOTE: *The configuration options are too numerous to detail here. Contact your WTC sales representative for assistance on configuration options.*

Installing the MedWeld 3005 2

To install the MedWeld 3005, you must provide the required connection (for either remote or discrete integration), configure the unit for the MedLAN network, set the network address and program the weld processor to meet your application requirements.

These steps are described in the sections that follow.

Getting Started

.

Making the Required Connections

To aid in installing the MedWeld 3005, tear out or copy the “Installation Checklist” on page 2-19. Use it as a checklist to follow these steps:

1. Make certain the circuit breaker handle on the enclosure is in the OFF (DOWN) position before attempting to open the door.

WARNING!



The door is interlocked with the circuit breaker to prevent opening the cabinet door while power is applied. DO NOT attempt to force open the door. Damage to the cabinet may result.

2. Inspect the inside of the enclosure for any damage caused in shipping. Check for any parts which may have come loose in shipping, any packing materials or loose connections.
3. Check the drain holes on the bottom of the cabinet. Remove any tape affixed over these holes for shipping.
4. Place the enclosure in the desired location. Secure it with the mounting tabs and holes provided. The cabinet is designed to be mounted using all four mounting tabs.



Caution:

When lifting any weight above 20 kg (~ 45 lb.), use either a two-man lift or an assisted lift.

WARNING!



WTC does NOT recommend drilling additional holes in the cabinet for additional brackets. If additional holes are required, make certain all components are covered to protect them from metal shavings. Metal debris (from drilling into the cabinet) can cause catastrophic failure. The WTC warranty does NOT cover damage caused by metal debris.

5. Removable plates may be provided to connect cooling water, weld bus voltage, the welding transformer and to allow for wiring into the I/O.
6. The fittings for cooling water are located on the bottom (or side) of the cabinet. Either pipes or hoses are acceptable.
7. Connect the cooling water and test for leaks BEFORE any wiring into the control is performed, to reduce the risk of electrical shock.



Caution:

Refer to page -xii for the requirements of cooling water quality and flow.

8. With the welding bus power off and properly locked out, connect the power cables from the welding bus to the top of the circuit breaker.
9. Verify proper sizing of cabling from the bus to the circuit breaker, and from the control to the weld transformer's primary circuit.
10. Provide the connection to the weld transformer. (Refer to the electrical schematics supplied with the control for assistance in connecting the welding transformer.)
11. Provide the I/O connections based on the control's communication scheme. See "Remote Integration" on page 2-4.

WARNING!

Check the control transformer for proper connections and voltage. Incorrect voltage from the control transformer can damage the I/O devices and/or present an electrical shock hazard to personnel.

12. Provide the MedLAN connections if a network connection is desired. Refer to “Providing MedLAN Connections” on page 2-9. Follow the recommendation provided in “MedLAN Wiring Specifications” on page 2-10.



Caution:

Physically separate the MedLAN cable from wiring greater than 50 volts. If the MedLAN cable must cross this wiring, it must do so at a 90° angle.

13. Inspect the setting of the circuit breaker’s magnetic trip. Verify that this setting is correct. Refer to “Circuit Breaker” on page 1-15.
14. If using the optional communications daughter board, configure the FieldBus DIP switch. Refer to “Setting the DIP Switches” on page 2-4 for further details.
15. If using the optional secondary current coil, inspect it and verify that its orientation is correct and the 2-pin Phoenix connector is secure.
16. Inspect all connections and verify proper crimping and torque settings. Verify that there are NO line-to-line shorts.
17. When making all the electrical connections to/from the control, verify that each connection is secure.
18. Verify that all I/O are present and correctly assigned in the software. Refer to the schematics supplied with the control.
19. Turn on the cooling water and ensure proper flow rate. The MedWeld 3005 control is now ready to power up.



Caution:

The inverter continually generates heat during operation. Water cooling is required when the unit is turned on. See page -xii for more details.

20. Program the required weld schedules (see “Weld Schedules” on page 4-1). Program the required settings of setup parameters (“Setup Parameters” on page 5-1). Program the stepper profile (refer to “Stepper Data” on page 6-1).
21. Verify proper hand-shaking of the I/O on power-up.

The MedWeld 3005 is now ready for welding.

Remote Integration

.

To install the system for remote integration, you must properly configure the RIO module (shown in Figure 5 on page 1-8). To configure the network card, you must correctly position the DIP switches to properly interpret the system addressing.

You may also wire into the combination module (shown in Figure 7 on page 1-13) to provide the local and safety I/O signals. Finally, provide the “blue hose” connection from the module to the RIO network.

Each of these steps are described in the sections that follow.

Providing Local and Safety I/O

For the remote integration scheme, you must wire into the RIO Local Combination module to provide certain critical local and safety I/O signals. These signals are defined in “Local and Safety I/O” on page 3-1.

Setting the DIP Switches

To configure the WTC 3005 for remote integration, you must correctly set the DIP switches. These switches enable the weld processor to properly interpret the system addressing and configuration.

WARNING!



To do this, FIRST remove power from the chassis. Then remove the RIO network module from the chassis.

Locate the DIP switches, shown in Figure 10 on page 2-5. The DIP switches are divided in two switch blocks: SW1 and SW2. These blocks fall into six groups:

- I/O Group (SW1)
- Rack Address (SW1)
- Rack Size (SW2)
- Last Rack (SW2)RS (Bit Rate Select) (SW2).
- Clear On Fault (SW2)
- BRS (Bit Rate Select) (SW2).

Figure 10: DIP Switch Locations

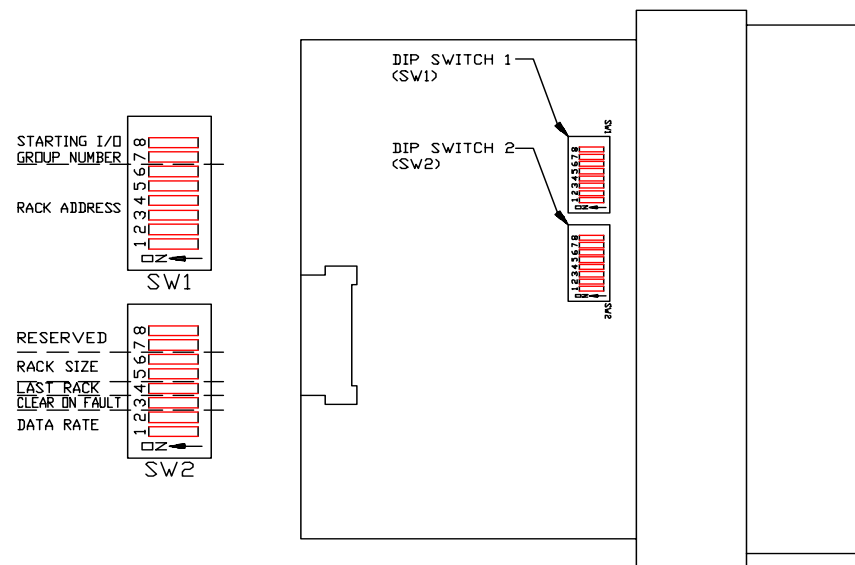

Selecting the I/O Group

The I/O group DIP switches are located in switch block SW1. Switches 7 and 8 determine the I/O group number.

DIP Switch		I/O Group Number	Valid Rack Configuration
7	8		
ON	ON	0	ALL
ON	OFF	2	3/4, 1/2, 1/4 rack
OFF	ON	4	1/2, 1/4 rack
OFF	OFF	6	1/4 rack

Selecting the Rack Size

The rack size DIP switches are located in switch block SW2. These DIP switches (5 and 6) determine the size of the RIO data transfer, with valid ranges from 1/4-rack to a full rack.

For a single WCU or a tri-pack system, set the rack size to 1/4 rack. A six-pack configuration requires setting a rack size of 1/2.

DIP Switch		Rack Size
5	6	
ON	ON	1/4
ON	OFF	1/2
OFF	ON	3/4
OFF	OFF	Full

Setting the Rack Address

The rack address DIP switches (1 – 6) are on switch block SW1. These switches set the physical address of the whole rack. Valid decimal values are 0 through 31, as shown in the following table.

DIP Switch Number						Address		
1	2	3	4	5	6	Dec.	Octal	Hex
ON	ON	ON	ON	ON	ON	00	00	00
ON	ON	ON	ON	ON	OFF	01	01	01
ON	ON	ON	ON	OFF	ON	02	02	02
ON	ON	ON	ON	OFF	OFF	03	03	03
ON	ON	ON	OFF	ON	ON	04	04	04
ON	ON	ON	OFF	ON	OFF	05	05	05
ON	ON	ON	OFF	OFF	ON	06	06	06
ON	ON	ON	OFF	OFF	OFF	07	07	07
ON	ON	OFF	ON	ON	ON	08	10	08
ON	ON	OFF	ON	ON	OFF	09	11	09
ON	ON	OFF	ON	OFF	ON	10	12	0A
ON	ON	OFF	ON	OFF	OFF	11	13	0B
ON	ON	OFF	OFF	ON	ON	12	14	0C
ON	ON	OFF	OFF	ON	OFF	13	15	0D
ON	ON	OFF	OFF	OFF	ON	14	16	0E
ON	ON	OFF	OFF	OFF	OFF	15	17	0F
ON	OFF	ON	ON	ON	ON	16	20	10
ON	OFF	ON	ON	ON	OFF	17	21	11
ON	OFF	ON	ON	OFF	ON	18	22	12
ON	OFF	ON	ON	OFF	OFF	19	23	13
ON	OFF	ON	OFF	ON	ON	20	24	14
ON	OFF	ON	OFF	ON	OFF	21	25	15
ON	OFF	ON	OFF	OFF	ON	22	26	16

DIP Switch Number						Address		
1	2	3	4	5	6	Dec.	Octal	Hex
ON	OFF	ON	OFF	OFF	OFF	23	27	17
ON	OFF	OFF	ON	ON	ON	24	30	18
ON	OFF	OFF	ON	ON	OFF	25	31	19
ON	OFF	OFF	ON	OFF	ON	26	32	1A
ON	OFF	OFF	ON	OFF	OFF	27	33	1B
ON	OFF	OFF	OFF	ON	ON	28	34	1C
ON	OFF	OFF	OFF	ON	OFF	29	35	1D
ON	OFF	OFF	OFF	OFF	ON	30	36	1E
ON	OFF	OFF	OFF	OFF	OFF	31	37	1F

Selecting the Last Rack

The last rack DIP switch is located in SW2. This switch (4) tells the I/O scanner whether this is the last logical fractional rack at the physical address.

Set this DIP switch to OFF if this *is* the last fractional rack at the physical address. Otherwise, set it to ON.

Setting the CLEAR ON FAULT Status

The CLEAR ON FAULT DIP switch is Switch 3 in switch block SW2. When setting this switch to OFF when the RIO network module detects that the PLC has entered Program, Test or Fault Mode, or detects a communications failure, the 3005 RIO module will immediately clear and hold clear all data bits in its Input Image Table.

If set to ON, all data bits will remain in their last state.

Setting the BRS (Bit Rate Select)

The BRS DIP switches are located in SW2. These DIP switches (1 and 2), determine the communications speed of the RIO link.

DIP Switch		Bit Rate Select
1	2	
ON	ON	57.6 kBaud
ON	OFF	115.2 kBaud
OFF	ON	230.4 kBaud
OFF	OFF	230.4 kBaud

DeviceNet Integration

.

To implement DeviceNet integration, the SLC rack requires two additional modules: The DeviceNet module and the combination module (for local control of certain critical I/O).

This integration scheme supports a network of DeviceNet devices, allowing rapid communications between industrial devices. The DeviceNet module communicates with the SLC controller to provide information from the welding environment to the weld processor.

DeviceNet communications protocol is an open network standard, maintained by the Open DeviceNet Vendor Association (ODVA). This protocol allows for peer-to-peer data (where any product can produce or consume messages and the DeviceNet product can function as Client, Server or both). The network can have up to 64 node addresses. Each node supports an infinite number of I/O.

To install the system using the DeviceNet integration, you must properly configure the DeviceNet module and insert it in the SLC rack. For instructions on installation, refer to “DeviceNet Integration” on page 1-8.

You may also wire into the combination module (to provide the local and safety I/O signals).

Finally, make the connection to the DeviceNet drop line at the terminal block plug provided on the DeviceNet module. To do this, match the wire insulation wire colors to the colors shown on the terminal block label.



Caution:

DO NOT wire into the network while the network power supply is turned on. This may short the network or disrupt communications.

For more information on the Input and Output image tables used with DeviceNet, refer to “DeviceNet I/O Tables” on page -21.

Discrete Integration

.

Installing the discrete integration scheme requires wiring into the input and output modules in the chassis. These modules appear in Figure 7 on page 1-13 and Figure 8 on page 1-14.

Refer to the drawing packet provided with your control for a complete list of the discrete I/O provided. A complete list of all available discrete I/O appears in “Discrete Integration” on page 3-5.

Providing MedLAN Connections

.

MedLAN (WTC’s Local Area Network) is a proprietary communications protocol. It defines how devices on the network communicate with each other.

NOTE: *The MedLAN address identifies each weld control’s location on the network; therefore each weld control’s address must be programmed BEFORE communication over the MedLAN channel is possible.*

Networking takes place over the MedLAN channel. Use a WTC data entry device (DEP-100, MedVIEW, MedLAP or WSS) for network communications or to program a single weld control.

However, for the MedLAN network, you **MUST** use a DEP-100S Programming Device to program the MedLAN address for each control on the network through the programming port at the top of the card. Refer to Figure 4 on page 1-6.

NOTE: *In some configurations, a connector is provided on the door of the enclosure for convenience in connecting the DEP-100. This port is internally wired to the weld processor card.*

This must be done before you can use MedLAN. If you do not program a MedLAN address, communication errors may result.

MedLAN and DEP-100S Connections

The network connection requires a WTC Network Power Pack for power to the DEP-100S programming device.

A Brad-Harrison, 3-pin bulkhead connector is located at the top right corner of the network power pack. This connector provides external 110/220 VAC power. The DEP-100S then plugs into the connector on the face of the network power pack.

The MedLAN cable connection originates at the 6-pin connector on the bottom of the network power pack. This cable runs to the 3-pin MedLAN connector (J2) on the 3005 weld processor card in the SLC chassis.

For network configurations, the MedLAN cable connection is daisy-chained to the other controls on the network.

MedLAN Wiring Specifications

The MedLAN interface is an optically-isolated RS-485 connection. The interface is a 3-position, removable Phoenix connector with a pin spacing of 5 mm. The baud rate of this connection is 9,600.

Cable Requirements

WTC recommends using the Belden 9463 cable or equivalent. The following tables list the cable pinouts.

MedLAN Connector (on the network power pack):

Designator	Pin #	Function	Wire Color (BELDEN #9463)
MDP2	6	+ 24 V.	
MDPS	5	Com	
MDP1	4	Not used	
MDL2 *	3	MedLAN Line 2	Clear
MDLS *	2	Line Shield	
MDL1 *	1	MedLAN Line 1	Blue

* Some versions of the control use a 6-pin MedLAN connector with all the positions connected as listed here. Other versions use a 3-pin MedLAN connector. It uses only these three pins as noted with an asterisk (*).

MedLAN Connector (on the weld processor card):

Designator	Pin #	Function	Wire Color (BELDEN #9463)
MDL2	3	MedLan Line 2	Clear
MDLS	2	Line Shield	
MDL1	1	MedLAN Line 1	Blue

Caution (when connecting with the DEP-104 Programming Device):



Remove power BEFORE attempting to connect or disconnect cabling. Exercise care when making the MedLAN cable connections. If the MedLAN cable should become connected to the MDP1 and MDP2 power connections, serious damage to communication components WILL occur.

WARNING!



NEVER connect any of the communication ports to the MDP- power wires. Damage to the ports or other internal components may result.

Designator	Function
MDL1 - MedLAN Line 1	This is the TX/RX + line of the RS-485 signal. Attach it to the blue wire of the cable.
MDL2 - MedLAN Line 2	This is the TX/RX - line of the RS-485 signal. Attach it to the clear or white wire of the cable.
Shield	Connect the shield to the drain wire of the cable.

Cable Routing Requirements

Wire the MedLAN network ONLY in a “daisy-chain” method. NEVER use “stub” wiring.

The maximum total length of the MedLAN network cable is 3,000 feet. Up to 30 weld controls may be connected to a single MedLAN network.

A maximum of one WSS (Welding Support System) and one Network Power Pack (DEP-100S), OR two Network Power Packs (DEP-100S), OR one computer running MedView or MedCommander may be connected to a single MedLAN network.

The MedLAN cable wire ends terminate into MTSB (Phoenix) connectors. Terminate the cable with this procedure:

1. Strip the cable jacket to 1 inch.
2. Remove foil shield strands outside the foil.
3. Cover the shield with heat shrink.
4. Cover the cable insulation end with one inch of heat-shrink tubing.
5. Strip 1/4 inch of insulation off each wire.
6. Install wires in each connector as shown in Figure 11 below.
7. Torque the terminal screws to 5 in.-lb.

Figure 11: Terminating the MedLAN Cable

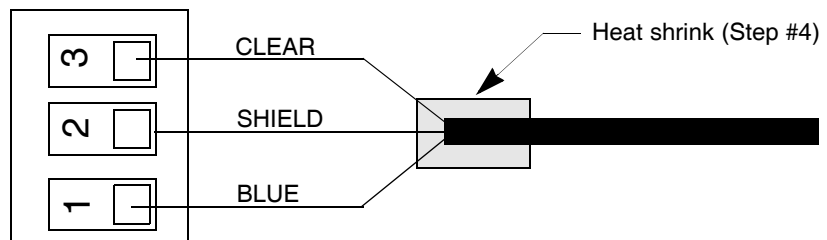

You must provide strain relief at the MedLAN cable entry and exit points at the weld control enclosure. If the enclosure requires drilling entry/exit holes, exercise cautions to assure that no metal shavings are left inside the control.

WARNING!



Be certain to cover all components to protect them from metal shavings. Metal debris (from drilling into the cabinet) can cause catastrophic failure. The WTC warranty does NOT cover damage caused by metal debris.

Physically separate the MedLAN cable from wiring greater than 50 volts. If the MedLAN cable must cross this wiring, it must do so at a 90° angle.

Figure 12 illustrates the recommended wiring configuration. Note that this diagram shows optional equipment.

Figure 12: Recommended MedLAN Wiring

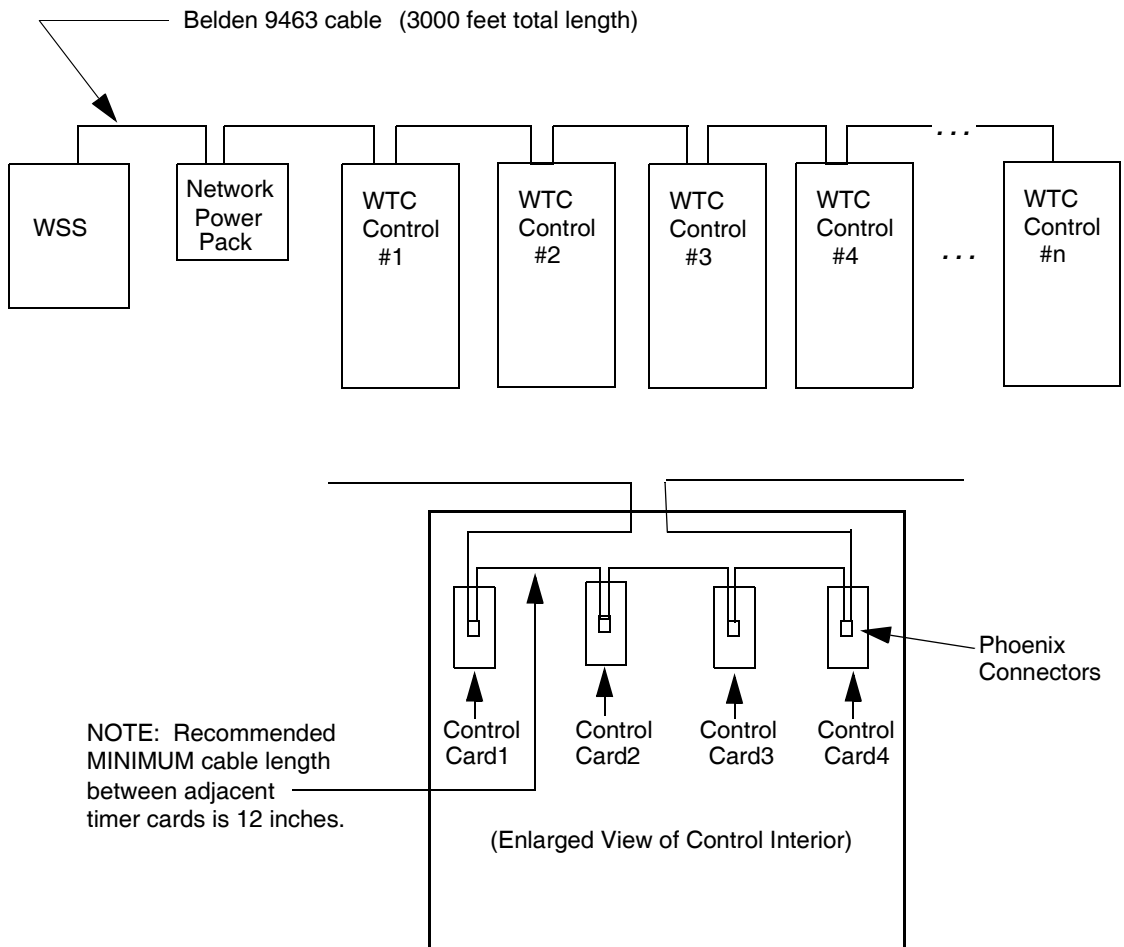

Setting the Weld Processor MedLAN Address

The MedWeld 3005 uses MedLAN (WTC's proprietary Local Area Network) to create a communications network between devices. After configuring each control, establishing the MedLAN connection and powering it up, you must set the MedLAN address for each device its before it can respond to the network.

Use the WTC DEP-100S to program the MedLAN address for each individual weld control, through the top (DEP) port of the weld processor card.

NOTE: *The steps required to set the address are listed below. Refer to the manual provided with the DEP-100S programming device for more information on operation.*

This illustrates the layout of the DEP-100S keypad and LCD:

Figure 13: WTC DEP-100S
Programming Device)

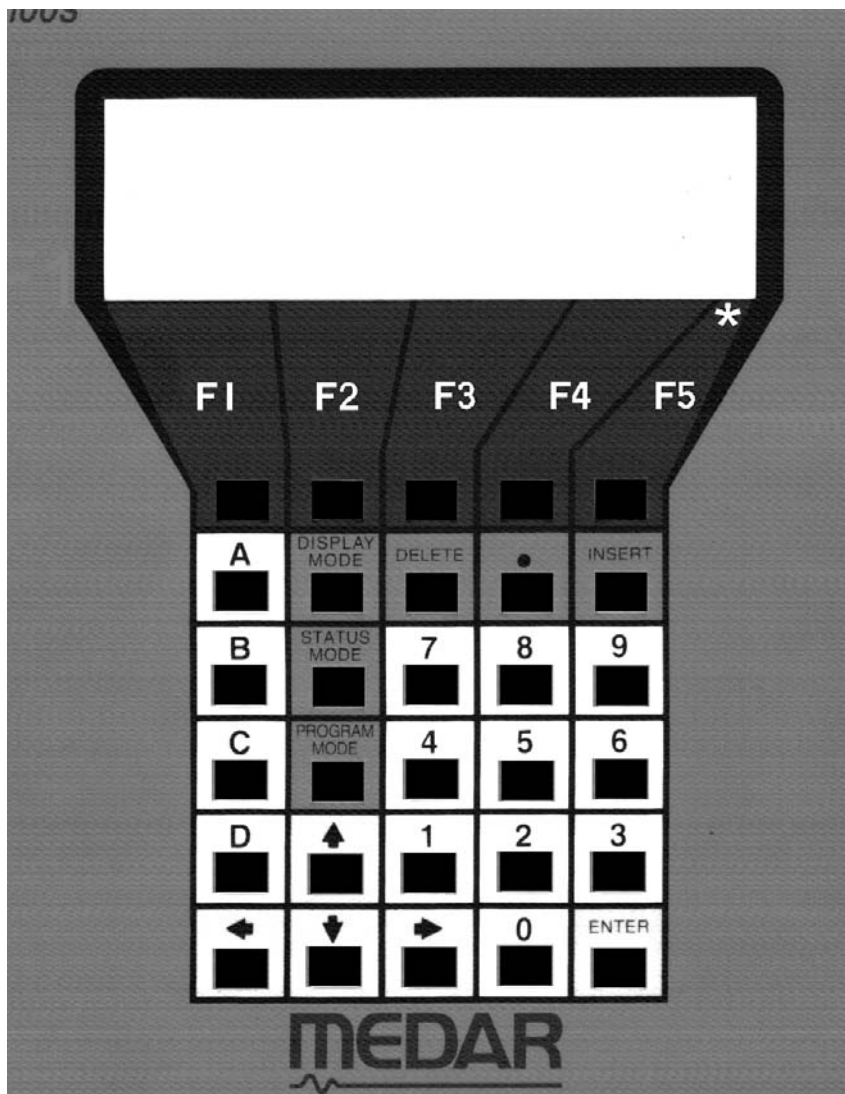

To set the addresses for each weld control, follow this procedure:

1. Plug the DEP-100S into the DEP (top) port on the weld processor card (or the DEP port on the enclosure door, if provided).

2. Press the key labeled **PROGRAM MODE** on the DEP-100S. You will see this screen:

```

POWER ON                                COMM ON
.....
- PROGRAM MODE -
REVIEW      REVIEW      REVIEW      RELOAD
SCHEDULE    STEPPER     SETUP      DEFLT  *
.....
F1          F2          F3          F4

```

3. Press **F5** on the DEP-100S (for additional functions). The following screen appears.

```

POWER ON                                COMM ON
.....
- PROGRAM MODE -
WELDER      TRANSFER    NETWORK
ID           DATA      ADDR          *
.....
F1          F2          F3          F4

```

4. Press **F4** to select network addressing (**NETWORK ADDR**). This display will appear.

```

POWER ON                                COMM ON
.....
NETWORK ADDRESS PROGRAMMING
port #02                                download  exit
.....
F1          F2          F3          F4

```

5. Press the **F1** key to select the port # (MedLAN address).
6. With the numeric keys, enter an address (“port”) number (00–29). In the example shown, the address is port 02.
7. Press **Enter** to tell the DEP-100S you have completed your selection.

8. Press the **F3** (**download**) to send the new MedLAN address to the device. (A message that the download was completed will appear briefly.)
9. Unplug the DEP-100S and move to the next control. Follow this procedure for every control in the network.



Caution:

Make certain that each device has a **unique** address. Duplicate addresses may cause the network to lock up.

Programming the Weld Processor

.

Each weld processor provides multiple functions for defining weld schedules. It also lets you configure the device to meet your application requirements by programming setup parameters. The control also provides a programmable stepper to compensate for lost current density over the life of the electrodes.

All of these features are programmable from several different programming devices:

- Plug the WTC DEP-100S programming device into the connector on the enclosure door or on the weld processor module or the WTC Network Power Pack.
- When connecting the MedWeld 3005 to a network controlled by the WTC Weld Support System (XWSS), programming and data acquisition can be done through WTC's proprietary programs.
- Use the WebVIEW communication programs to program weld schedules, steppers and setup parameters from a Microsoft Windows™ interface.

Each programming option is outlined below. For more complete information, refer to the manual provided with each programming device.

DEP-100S Programming Device

WTC's DEP-100S Programming Device is a data entry device. Use it to program one, several or up to 30 weld processors on a MedLAN network.

- When programming locally, the DEP-100S is plugged directly into the port on the WTC control.
- When using a MedLAN network, a WTC Network Power Pack is required to provide external power for the DEP-100S.

When communicating through a local port, the DEP-100S is still required (to set the MedLAN address for each weld processor). The DEP-100S is shown in Figure 13 on page 2-14. Its multi-line display and “soft” function keys allow you to see weld data or to program weld settings.

As described in the *DEP-100S Programming Guide*, the DEP-100S displays information based on the software revision contained in both the DEP and the weld processor. This manual explains how to use displays that are specific to the MedWeld 3005 processor.

Refer to “Display at the DEP-100S” on page 7-3 for details on how to use the DEP-100S stepper status and stepper profile programming displays.

Welding Support System (XWSS)

The WTC Welding Support System (XWSS) allows you to control a network of WTC controls (including the MedWeld 3005). XWSS runs in the UNIX™ environment under the X–Windows graphic interface.

Programming and data acquisition can also be performed from a single host personal computer. Refer to the XWSS documentation or consult your WTC sales representative for more information.

This page is intentionally left blank.

Installation Checklist

.

Copy or tear out this checklist, to aid in installing the MedWeld 4000. Be certain to verify and check off each step after performing it. Also, the responsible service technician should sign their initials after completing each step.

<u>Step Number</u>	<u>Check-off</u>	<u>Initials</u>	<u>Action to Take</u>
Step 1	<input type="checkbox"/>	_____	Ensure proper lock-out at welding bus. Circuit breaker handle DOWN.
Step 2	<input type="checkbox"/>	_____	Inspect interior of control for loose/missing parts and/or damage in shipping.
Step 3	<input type="checkbox"/>	_____	Check drain holes; ensure they are open.
Step 4	<input type="checkbox"/>	_____	At desired location, mount control by ALL 4 mounting tabs.
Step 5	<input type="checkbox"/>	_____	Remove access plates to drill for: Weld bus, cooling water, welding transformer and I/O.
Step 6	<input type="checkbox"/>	_____	Connect cooling water supply to fittings.
Step 7	<input type="checkbox"/>	_____	Lock-out at welding bus. Connect power cables: Bus to line side (top) of circuit breaker.
Step 8	<input type="checkbox"/>	_____	Connect weld transformer.
Step 9	<input type="checkbox"/>	_____	Connect all I/O points.
Step 10	<input type="checkbox"/>	_____	Connect external power. WARNING! Verify Proper connections and voltage.
Step 11	<input type="checkbox"/>	_____	Make MedLAN connections.
Step 12	<input type="checkbox"/>	_____	Verify CORRECT magnetic trip setting on circuit breaker.
Step 13	<input type="checkbox"/>	_____	(If using optional FieldBus communications): Configure DIP switch on daughter board.
Step 14	<input type="checkbox"/>	_____	(If using optional secondary current coil): Inspect and verify correct orientation and secure connection.

- | | | | |
|----------------|--------------------------|-------|--|
| Step 15 | <input type="checkbox"/> | _____ | Inspect all connections: Verify proper crimping and torque. Verify NO line-to-line shorts. Refer to page 2-19. |
| Step 16 | <input type="checkbox"/> | _____ | Verify all I/O are present and correctly assigned in software. |
| Step 17 | <input type="checkbox"/> | _____ | Ensure cooling water supply and proper flow rate. |
| Step 18 | <input type="checkbox"/> | _____ | Program required weld schedules, settings for setup parameters and stepper profile. |
| Step 19 | <input type="checkbox"/> | _____ | Verify proper hand-shaking of I/O on power-up. |

The MedWeld 3005 communicates with automation equipment using one of three integration schemes:

- **Remote I/O.** This transmits I/O via the “Blue Hose” connection to a host PLC outside the weld control enclosure.
- **DeviceNet,** where I/O is transmitted to a DeviceNet drop line and sent to a network via the PLC host.
- **Discrete I/O.** Inputs and outputs are directly wired into the control’s enclosure.

The type of integration provided is determined by software provided in the ladder logic for the PLC, as well as the physical modules contained in the PLC chassis. These are detailed in “Physical Description” on page 1-2.

The following sections describe each option and the I/O provided.

Local and Safety I/O

.

When the MedWeld 3005 is part of a network (as with the Remote I/O or DeviceNet integration), the WTC combination module provides for local (discrete) control of certain critical inputs and outputs.

These outputs are the same for both integration options. As described in “Providing Local and Safety I/O” on page 2-4, the connections to these I/O should be provided. These tell the processor factors such as the status of the isolation contactor, the control stop condition and fault conditions.

This I/O is in addition to the I/O mapping provided for remote I/O and DeviceNet operation.

Local Inputs

This section covers all possible inputs/outputs supported. Your application may not require all of this I/O. Refer to the drawing packet provided for your exact I/O availability and designations.

CONTROL STOP Input

When this input is de-activated, the control aborts the present schedule and will not initiate another schedule until the input becomes activated. The isolation contactor also drops out (to disable weld current). A CONTROL STOP fault condition is generated.

Attempting to initiate a weld when this input is inactive will activate a CONTROL STOP Fault and de-activate the NO FAULT Output.

ISOLATION CONTACTOR Input

This is an input to the weld control enclosure, showing whether the isolation contactor is open or closed. It is normally open.

If this contact fails to change states after a valid schedule is initiated, the control will generate a ISO-CNTR OFF WHEN NEEDED fault condition.

If this contact fails to return to its original state after the contactor is turned off (including the Isolation Contactor Delay), the control will generate an ISO-CNTR ERR BKR TRIPPED fault condition. It will also de-energize the NO FAULT output and trip the circuit breaker.

THERMAL SWITCH Input

This input to the weld processor indicates that the weld enclosure has reached an over-temperature condition.

If this input is not active when the control receives the signal to initiate a weld, the weld processor completes the schedule in No Weld, generates a SYSTEM COOLING fault and de-energizes the NO FAULT output (to indicate an active fault condition).

DUAL CONTACTOR Input

This input enables a tri-pack system to run as a dual-pack (only two active weld processors). If this input is jumpered HIGH, the PLC will not export data to the third weld processor in the chassis. This lets you disable or remove the third weld processor card from the chassis.

(When this input is LOW, the third weld processor is enabled and cannot be removed from the chassis.)

Local Outputs

NO FAULT Output

This output is ON to indicate that the control is functioning normally. If the control shuts down as the result of a fault condition, this output will be turned OFF.

ALERT Output

This output is OFF to indicate that the control is functioning normally. Alert conditions are usually less serious than faults and are normally used to warn the operator that maintenance is required.

ISOLATION CONTACTOR Output

The ISOLATION CONTACTOR output operates the weld transformer isolation contactor. Output #12 on the SLC output module informs the MFDC inverter when it is required to pull in the charging pack.

The charging pack remains energized. It will drop out only when an inverter fault is generated, or during an emergency stop condition.

SHUNT TRIP Output

Activating this output trips the circuit breaker in case of a catastrophic failure.

INITIATE ACKNOWLEDGE Output

This output indicates that a schedule is being executed by the weld processor.

Remote I/O

• • • • • • • • • •

When remote integration (RIO) is used, the WTC 3005 RIO Network Module must be mounted in the SLC-500's rack. This module provides a direct link between the control enclosure and the Allen-Bradley RIO network module located in the host PLC. (The host PLC then communicates with machine controllers and robots.)

The local and safety I/O is wired directly into the Combination module, which provides inputs and outputs for local use and safety interlocks.

The remote integration scheme uses some of the same signals as those used in the discrete I/O operation. The main difference is that the I/O is transmitted over a remote I/O link from the RIO Network Module (in the controller chassis) via the "blue hose" connection to a host PLC outside the weld control enclosure.

The image table for I/O used with remote I/O integration is provided in "RIO Image Tables" on page A-1.

Organization of the DeviceNet I/O

• • • • • • • • • •

Using DeviceNet integration requires the Allen-Bradley™ DeviceNet Module (#1747-SDN Scanner Module). It is mounted in the SLC-500 programmable controller rack.

This module establishes a direct link between the control enclosure and the host PLC. The module provides the drop to the DeviceNet as well as communication with the PLC.

The local and safety I/O is wired directly into the Combination module. This module provides inputs and outputs for local use and safety interlocks.

The DeviceNet integration scheme uses some of the same signals as those used in the discrete I/O operation. The major difference is that the I/O is transmitted over a DeviceNet link from the DeviceNet module (in the controller chassis).

The DeviceNet module provides I/O for a six- or 12-pack configuration. (When using a 12-pack configuration with the DeviceNet integration, two network modules are required.)

The DeviceNet image table uses nodes 30 and 31. The image tables are shown in "DeviceNet I/O Tables" on page A-21.

Discrete Integration

• • • • • • • • • • •

The discrete interface (DIO) scheme allows the weld control to exchange data points with any automation system.

For further information, refer to “Discrete Input Modules” on page 1-13. To make these inputs available to the weld processor, and to allow the MedWeld 3005 to activate the outputs, wire into the discrete I/O modules in the controller rack.

I/O Definitions

• • • • • • • • • • •

NOTE: *This chapter defines **all** possible I/O. Your weld processor may not provide all of this I/O, based on the requirements of your application. Refer to the drawing packet provided for your exact I/O availability and designations.*

Inputs BINARY SELECT Inputs (#1, #2, #4, #8 & #16)

These inputs select the schedule to be initiated (1 – 31). The schedule is selected by a combination of these inputs. Each input has a weighted value (1, 2, 4, 8 or 16). The schedule initiated is the one selected by adding the weighted values of the active inputs.

For example, to initiate schedule #4, activate BINARY SELECT Input #4. To initiate schedule #7, activate BINARY SELECT Inputs #1, #2, and #4 (because $1 + 2 + 4 = 7$).

WELD ENABLE Input

When this input is activated, the weld control executes the schedule that was selected by the BINARY SELECT Inputs.

NOTE: *If your application does not use this input, the control uses a two-cycle timed delay to determine when all of the inputs are active. (After receiving a BINARY SELECT or PARITY Inputs, the control delays for two cycles to assure that all of the desired inputs have become active.)*

PARITY Input

The control will recognize only an ODD number of BINARY SELECT Inputs. If the schedule to be operated requires closure of an even number of BINARY SELECT Inputs, the PARITY Input must also be closed to provide the required odd number of inputs.

This arrangement helps to prevent possible malfunctions if a required input should fail to close.

WELD/NO WELD Input

This is a Weld Input to the control. With this input closed (HIGH), the control is in Weld Mode. If this input is open, the control is in No Weld Mode.

With this input open (No Weld Mode), the control will turn on the NO WELD Output and no weld current will flow.

NO STROKE/NO WELD Input

When this input is active, the control is in No Stroke/No Weld. This tells the weld control to cycle without supplying current and without turning on the valves. This input affects the weld valves only. It does not affect any other outputs.

CONTROL STOP Input

This is a normally HIGH input. When this input goes LOW (de-activated) the control aborts the current schedule, generates a CONTROL STOP Fault, de-activates the NO FAULT Output and will not initiate another schedule until this input goes HIGH.

TRANSFORMER OVER-TEMPERATURE Input

This input tells the state of the cooling system. It is provided as an external welding transformer over-temperature switch. If not used, this input must be jumpered HIGH.

If this input is not active when the control receives a schedule initiate, a SYSTEM COOLING Fault will be generated, and the NO FAULT Output will be de-energized.

A SYSTEM COOLING Fault also occurs if a weld schedule contains Function #79 (WAIT nnn CY FOR SYSTEM COOLING), and this input does not become active within the number of cycles specified.

SCR THERMAL SWITCH Input

This input to the weld processor indicates that an SCR has reached an over-temperature condition. It also acts as a ready to weld (RTW) signal from the regulator board to the inverter assembly.

If this input is not active when the control receives the signal to initiate a weld schedule, the weld processor generates a SYSTEM COOLING fault and de-energizes the NO FAULT output, to indicate an active fault condition. It completes the sequence in no weld.

The weld processor also generates a SYSTEM COOLING fault and sequence in No Weld if the weld schedule contains the function WAIT nnn CYC FOR SYSTEM COOLING and this input does not become active within the number of cycles specified.

SYSTEM COOLING Input

This input tells the weld processor the state of the contactor cooling system. If the weld schedule contains the function WAIT nnn CY FOR SYSTEM COOLING and this input does not become active within the programmed number of cycles, the weld processor completes the weld schedule in No Weld.

The function CHECK SYSTEM COOLING will complete the sequence in No Weld if the input is not active when checked by the weld schedule.

If the schedule contains the unconditional wait function WAIT FOR SYSTEM COOLING and the initiate is removed before this input becomes active, the control will abort the weld schedule and generate a SYSTEM COOLING fault.

RETRACT 1 PILOT Input

This input changes the state of the RETRACT VALVE 1 output. The action of the valve is based on the status of the Retract Mode setup parameter.

NOTE: *If your application is set to support dual-solenoid retract valves, this input will activate Retract Valve A and B, based on the cylinder type (CYL) setup parameter. Refer to page 5-13.*

RETRACT 2 PILOT Input

This input changes the state of the RETRACT VALVE 2 output. The action of the valve depends on the status of the Retract Mode setup parameter.



Caution:

On power-up, it may be necessary to activate the RETRACT Input (1 or 2) to energize the output, to correct the internal state of the retract pilot.

CLOSE BACKUP OPEN BACKUP

These two inputs control the status of the BACKUP VALVE outputs, opening and closing as required by the user.

When this input is set to open, the OPEN BACKUP VALVE output is set. When set to closed, the CLOSE BACKUP VALVE output is set. (If *both* inputs are set, the OPEN BACKUP VALVE output is set.)

FAULT RESET Input

This input allows the control to remotely reset all faults.

STEPPER RESET Input

This input will reset all the steppers to Step 1 and the weld count to 0.

TIP DRESS/ADVANCE Input

This input moves the stepper to the beginning of the second step in the stepper profile.

PRESSURE SWITCH Input

If the weld schedule contains the function WAIT nnn CY FOR PRESSURE SWITCH, and this input does not become active in the number of cycles specified, the control generates a PRESSURE SWITCH fault and continues with the schedule.

The control aborts the weld schedule and generates a PRESSURE SWITCH fault if the weld initiate is removed while the control is waiting in the function WAIT FOR PRESSURE SWITCH.

ISOLATION CONTACTOR Input

This input to the weld processor shows the state of the isolation contactor: Either open or closed. It is normally open.

If this contact fails to change states after a valid schedule is initiated, the control will generate a ISO-CNTR OFF WHEN NEEDED fault condition.

If this contact fails to return to its original state after the contactor is turned off (including the Isolation Contactor Delay), the control will generate an ISO-CNTR ERR BKR TRIPPED fault condition. It will also de-energize the NO FAULT output and trip the circuit breaker.

ENABLE ISOLATION CONTACTOR Input

This input must be active (HIGH) to enable the weld processor to activate (close) the isolation contactor.

ISOLATION CONTACTOR SAVER Input

This input tells the weld processor to enable the isolation contactor delay timer. The delay timer (programmed in the setup parameters, as described on page 6-12), holds the isolation contactor closed after a weld schedule is completed, to prevent it from dropping out between welds.

If this input is active at the end of a schedule, the weld processor will hold the isolation contactor closed for the amount of time programmed.

If this input is not active, the isolation contactor will drop out at the end of the weld schedule. However, if this input drops out during the delay time, the remaining time on the delay timer is aborted and the isolation contactor is immediately opened.



Caution:

(If the weld schedule contains Function #77, it overrides the isolation contactor delay which was programmed in the setup parameters. Refer to page 6-12 for more information.)

PROGRAM MODE SECURITY Input

If this input is active (locked HIGH), only data under the Stepper Status Mode and Heat Display Mode can be changed.

If this input is used in conjunction with the HT DISPLAY SECURITY input, only data under the Stepper Display Mode can be changed.

HHT DISPLAY SECURITY Input

This input must be used in conjunction with the PRM MODE SECURITY Input. If this input is active (locked HIGH), there can be NO changes made to any of the programmable data except under the Stepper Status Mode.

User Inputs 1 – 8

These are generic inputs from the SLC. These inputs can be used to force the weld processor to wait in a weld schedule using the user input functions, as described on page 5-11.



Caution:

These inputs are arbitrarily assigned numbers from 1 -8. Do NOT confuse this label (for example, Input #1) used by the weld function with an actual input position. That is, User Input #1 is NOT NECESSARILY assigned to input #1.

Outputs

WELD VALVE Outputs (1 – 6)

These outputs are activated or de-activated when the MedWeld 3005 executes Function #54 (TURN ON WELD VALVE #n) or Function #55 (TURN OFF WELD VALVE #n).

NOTE:

Valves #1 and #2 are shared outputs; they function as the two Advance (Fluid) valves when enabling OHMA cylinder operation for the processor.

PRESSURE SELECT Outputs (1 – 4)

These outputs are activated or de-activated when the MedWeld 3005 executes functions #56 (TURN ON PRESSURE SELECT #n) and #57 (TURN OFF PRESSURE SELECT #n).

**RETRACT 1 VALVE
RETRACT 2 VALVE**

These outputs respond to the on/off status of the RETRACT VALVE 1 and 2 PILOT Inputs, based on the Retract Mode setup parameter. Refer to page 6-10 for more details.

ISOLATION CONTACTOR Output

This output is activated or de-activated when the MedWeld 3005 executes function #52 (TURN ON ISOLATION CONTACTOR) or function #53 (TURN OFF ISOLATION CONTACTOR).

Function #77 (ISOLATION CONTACTOR DELAY nn SEC) also affects this output, as described in the setup parameters on page 6-12.

The output is used to remove power from the high-voltage circuitry when it is not required by the weld schedule.

SHUNT TRIP Output

This output is provided to trip the circuit breaker in case of a catastrophic failure.

WELD/NO WELD Output

When the WELD/NO WELD input is opened, it energizes this output (to indicate that the control is in No Weld Mode). If a valid weld initiate is received while the control is in No Weld Mode, the weld schedule will schedule normally, but weld current WILL NOT FLOW.

FAULT Output

This output is normally OFF, indicating that the control is functioning normally. If the control shuts down as the result of a fault condition, this output will be turned ON.

NO FAULT Output

Certain applications use the NO FAULT output (rather than the FAULT output above). This output is normally ON (to indicate that no fault conditions exist). If the control shuts down as the result of a fault condition, this output will be turned OFF.

NO ALERT Output

This output is normally ON. It turns OFF to indicate an alert condition. Alert conditions are usually less serious than faults and normally serve to warn the operator that maintenance is required.

ALERT Output

This output is normally OFF and turns *on* to indicate an alert condition. Alert conditions are usually less serious than faults and are normally used to warn the operator that maintenance is required.

INITIATE ACKNOWLEDGE Output

This output indicates that the control is executing a schedule.

END OF STEPPER Output

The control will activate this output when the stepper completes the last weld in the last step.

This output becomes active when one or more steppers has reached the end of its programmed limit.

WELD IN PROGRESS Output

The control turns this output ON and OFF in response to the output control function. For more details, see “Output Control Functions” on page 4-8.

WELD COMPLETE Output

This output turned on and off by the weld control in response to Functions #50 and #51. Refer to “Output Control Functions” on page 4-8.

READY TO WELD Output

When active, this output indicates that the control is ready to weld and will pass current if

- The control is in Weld Mode,
- NO faults exist,
- The CONTROL STOP input is HIGH,
- The WCU is synchronized with the line voltage,
- System cooling is provided:
 - The SCR OVER TEMP input is closed
 - On DIO/RWC1-P2 controls only: The TRANSFORMER OVER TEMP input is closed.

When this output is activated, the **RTW** LED on the WTC weld processor will light.

STEPPER APPROACHING LAST STEP

For linear steppers, this output will activate when the control reaches the start of the last step in the stepper profile.

For SureWeld steppers, this output will light when the control reaches the programmed value in the Stepper Approaching Max. Welds setup parameter.

WELD MISMATCH Output

This output is active to indicate that the control is in Weld Mode and the data entry device is in No Weld Mode.

User Outputs (1-8)

These are generic outputs to the SLC. The weld processor turns these outputs ON or OFF in a weld schedule, using the functions described in “Output Control Functions” on page 4-8.



Caution:

These outputs are arbitrarily assigned numbers from 1–8. Do NOT confuse this **label** (Output #1, for example) used by the weld function with an **actual output** position. That is, User Output #1 is NOT NECESSARILY assigned to output #1.

DEP-100S Abbreviations

• • • • • • • • • •

The DEP-100S provides an I/O Status display to help troubleshoot the I/O. This display shows the state of each input and output provided by your control.

Status indications are either a **0** or a **1**. Zero indicates the input or output is *inactive*. One indicates that the input or output is *active*.

The following tables list the abbreviations used to represent the I/O for DeviceNet or RIO at the DEP-100S Programming Device.

Input Abbreviations

Note: The processor displays all of the possible I/O on the DEP-100S programming device. However, only the Local and Safety I/O and the I/O in the image table are accessible. (Other I/O can be accessed only through local ladder logic.) For more details, refer to the drawing package provided with your control.

BINARY SELECT #1 Input.....	BS1
BINARY SELECT #2 Input.....	BS2
BINARY SELECT #4 Input.....	BS4
BINARY SELECT #8 Input.....	BS8
BINARY SELECT #16 Input.....	BS16
WELD SCHEDULE ENABLE Input.....	INT
WELD/NO WELD Input (HIGH for weld).....	WLD
BINARY SELECT #32 Input	BS32
CONTROL STOP Input (HI = operational, LOW = control stop).....	
ISOLATION CONTACTOR SAVER Input.....	CSTP
REMOTE STEPPER RESET Input.....	CSVR
FAULT RESET Input.....	SR
PROGRAM MODE SECURITY Input	FR
HEAT DISPLAY SECURITY Input	PSEC
TIP DRESS/ADVANCE Input.....	HSEC
PARITY (Odd) Input /BINARY SELECT #64	TIPD
	PTY

PRESSURE SWITCH Input.....	PS1
WELD PROCEED Input.....	WPRO
STEPPER AUXILIARY COUNTER RESET Input..	SACR
RETRACT PILOT #1 Input.....	RP1
RETRACT PILOT #2 Input.....	RP2
Programmable Input #1	PRG1
Programmable Input #2	PRG2
Programmable Input #3	PRG3
Programmable Input #4	PRG4
Programmable Input #5	PRG5
Programmable Input #6	PRG6
Programmable Input #7	PRG7
Programmable Input #8	PRG8
SYSTEM COOLING (SCR THERMAL SWITCH)	
Input.....	COOL
ISOLATION CONTACTOR (AUXILIARY CONTACTS) Input.....	
	IC
User Input #1	UI1
User Input #2	UI2
User Input #3	UI3
User Input #4	UI4
User Input #5	UI5
User Input #6	UI6
User Input #7	UI7
User Input #8	UI8

Output
Abbreviations

WELD IN PROGRESS Output.....	WIP
WELD FAULT Output (LOW for fault).....	FLT
WELD ALERT Output	ALT
WELD/NO WELD MISMATCH Output.....	WM
STEPPER IS RESET Output	SRST
WELD COMPLETE Output	WCMP
READY TO WELD Output	RTW
HAS WELDED Output	HWO
END OF STEPPER Output.....	EOS
STEPPER ALERT Output	SALT
TIP DRESS REQUEST	TPDR
STEPPER AUXILIARY COUNTER AT MAXIMUM	SACM
VALVE #1/ADVANCE (Fluid) VALVE #1 Output ...	VLV1
VALVE #2/ADVANCE (Fluid) VALVE #2 Output ...	VLV2
VALVE #3 Output.....	VLV3
VALVE #4 Output	VLV4
VALVE #5 Output.....	VLV5
VALVE #6 Output.....	VLV6
RETRACT VALVE #1	RV1
RETRACT VALVE #2	RV2

PRESSURE SELECT #1 Output	PV1
PRESSURE SELECT #2 Output	PV2
PRESSURE SELECT #3 Output	PV3
PRESSURE SELECT #4 Output	PV4
INTENSIFICATION (Air) VALVE Output.....	INTV
WELD/NO WELD Output (LOW for weld).....	WNO
ISOLATION CONTACTOR (SSR Relay) Output ...	SSR
SHUNT TRIP Output.....	PO2
INITIATE ACKNOWLEDGE Output	IACK
User Output #1.....	UO1
User Output #2.....	UO2
User Output #3.....	UO3
User Output #4.....	UO4
User Output #5.....	UO5
User Output #6.....	UO6
User Output #7.....	UO7
User Output #8.....	UO8

DIO Abbreviations

The following table shows the abbreviations the DEP-100S will display for each discrete input or output.

Discrete Inputs

BINARY SELECT #1 Input.....	FS2
BINARY SELECT #2 Input.....	FS3
BINARY SELECT #4 Input.....	FS4
BINARY SELECT #8 Input.....	FS5
BINARY SELECT #16 Input.....	FS6
WELD SCHEDULE ENABLE Input.....	FSE
WELD/NO WELD Input (HIGH for weld).....	NW2
BINARY SELECT #32 Input.....	FS7
CONTROL STOP Input (HI = operational, LOW = control stop).....	CS2
ISOLATION CONTACTOR SAVER Input.....	CSVR
REMOTE STEPPER MANUAL RESET Input.....	A2
FAULT RESET Input.....	FR
PROGRAM MODE SECURITY Input	PSEC
HEAT DISPLAY SECURITY Input	HSEC
TIP DRESS/ADVANCE Input.....	TIPD
PARITY (Odd)/BINARY SELECT #64 Input	PTY
PRESSURE SWITCH Input.....	PS1
WELD PROCEED Input.....	WPRO
STEPPER AUXILIARY COUNTER RESET Input ..	SACR
RETRACT PILOT #1 Input.....	RP1
RETRACT PILOT #2 Input.....	RP2

Programmable Input #1	PRG1
Programmable Input #2	PRG2
TRANSFORMER OVER-TEMPERATURE Input ..	TS2
Programmable Input #4	PRG4
Programmable Input #5	PRG5
Programmable Input #6	PRG6
Programmable Input #7	PRG7
Programmable Input #8	PRG8
SYSTEM COOLING Input (SCR THERMAL SWITCH + TRANSFORMER OVER-TEMP Inputs	COOL
ISOLATION CONTACT (Auxiliary Contacts) Input	IC
User Input #1	UI1
User Input #2	UI2
User Input #3	UI3
User Input #4	UI4
User Input #5	UI5
User Input #6	UI6
User Input #7	UI7
User Input #8	UI8

Discrete Outputs

WELD IN PROGRESS Output.....	WIP
FAULT Output (LOW for fault)	FLT
WELD ALERT Output	ALT
WELD / NO WELD MISMATCH Output	WM
STEPPER RESET Output	SRST
WELD COMPLETE Output.....	WCMP
READY TO WELD Output	RTW
HAS WELDED Output	HWO
END OF STEPPER Output	EOS
STEPPER ALERT Output	SALT
TIP DRESS REQUEST Output	TPDR
STEPPER AUXILIARY COUNTER AT MAXIMUM	SACM
VALVE #1/ADVANCE (Fluid) VALVE #1 Output ...	SV2
VALVE #2/ADVANCE (Fluid) VALVE #2 Output ...	SV3
VALVE #3 Output.....	SV4
VALVE #4 Output	SV5
VALVE #5 Output.....	SV6
VALVE #6 Output.....	SV7
RETRACT VALVE #1 Output.....	RV1
RETRACT VALVE #2 Output.....	RV2
PRESSURE SELECT #1 Output	PV1
PRESSURE SELECT #2 Output	PV2
PRESSURE SELECT #3 Output	PV3

PRESSURE SELECT #4 Output	PV4
INTENSIFICATION (Air) VALVE #1 Output.....	INTV
WELD/NO WELD Output (LOW for weld).....	NWO
ISOLATION CONTACTOR (SSR Relay) Output ...	SSR
SHUNT TRIP Output.....	PO2
INITIATE ACKNOWLEDGE Output.....	IACK
User Output #1.....	UO1
User Output #2.....	UO2
User Output #3.....	UO3
User Output #4.....	UO4
User Output #5.....	UO5
User Output #6.....	UO6
User Output #7.....	UO7
User Output #8.....	UO8

DEP-100S P2 (MDS-555-Style) Abbreviations

Inputs

BINARY SELECT #1 Input.....	FS2
BINARY SELECT #2 Input.....	FS3
BINARY SELECT #4 Input.....	FS4
BINARY SELECT #8 Input.....	FS5
BINARY SELECT #16 Input.....	FS6
WELD SCHEDULE ENABLE.....	FSE
WELD/NO WELD Input (HIGH for weld).....	WLD
BINARY SELECT #32 Input.....	FS7
CONTROL STOP Input (LOW for control stop)	CS2
ISOLATION CONTACTOR SAVER Input.....	2S13
STEPPER RESET Input	A2
FAULT RESET Input.....	FR
PROGRAM MODE SECURITY Input	PSEC
HEAT DISPLAY SECURITY Input	HSEC
TIP DRESS/ADVANCE Input.....	TIPD
PARITY (Odd)/BINARY SELECT #64 Input	PTY
ENABLE ISOLATION CONTACTOR Input.....	WCE
NO STROKE/NO WELD Input.....	NSNW
TRANSFORMER OVER-TEMP Input.....	TS2
CLOSE BACK-UP CYLINDER Input.....	CLBU
OPEN BACK-UP CYLINDER Input.....	OPBU
CLOSE BACK-UP VALVE Output Status	SV6A
OPEN BACK-UP VALVE Output Status	SV6B
SYSTEM COOLING Input (SCR THERMAL SWITCH input + TRANSFORMER OVERTEMP)..	COOL
ISOLATION CONTACTOR Input (AUXILIARY CONTACTS input)	IC

Spare Input #1	SPI1
Spare Input #2	SPI2
Spare Input #3	SPI3
Spare Input #4	SPI4
Spare Input #5	SPI5
Spare Input #6	SPI6
Spare Input #7	SPI7
Spare Input #8	SPI8

Outputs

WELD IN PROGRESS Output.....	WIP
FAULT Output (LOW for fault)	FLT
ALERT Output.....	ALT
WELD/NO WELD MISMATCH Output.....	WM
STEPPER RESET Output	SRST
WELD COMPLETE Output.....	WCMP
READY TO WELD Output	RTW
HAS WELDED Output	HWO
END OF STEPPER Output.....	EOS
STEPPER APPRO. LAST STEP Output	SALT
TIP DRESS REQUEST.....	TPDR
VALVE #1/ADVANCE (Fluid) VALVE #1 Output ...	SV2
VALVE #2/ADVANCE (Fluid) VALVE #2 Output ...	SV3
VALVE #3 Output.....	SV4
VALVE #4 Output	SV5
VALVE #5 Output.....	SV6
VALVE #6 Output.....	SV7
INTENSIFICATION (Air) VALVE	INTV
WELD/NO WELD Output (LOW for weld).....	WNO
ISOLATION CONTACTOR (SSR Relay) Output ...	SSR
SHUNT TRIP Output.....	PO2
INITIATE ACKNOWLEDGE Output	IACK
Spare Output #1.....	FCB1
Spare Output #2.....	FCB2
Spare Output #3.....	FCB3
Spare Output #4.....	FCB4
Spare Output #5.....	FCB5
Spare Output #6.....	FCB6
Spare Output #7.....	FCB7
Spare Output #8.....	FCB8

The MedWeld 3005 control is a full-function device, capable of storing up to 99 unique weld schedules. Each weld schedule can then be assigned to one of 99 independent steppers.

Several methods are available to program the weld processor. Refer to “Programming the Weld Processor” on page 2-16 for more information, or refer to the documentation provided with each programming device.

This chapter does not describe how to create or modify a weld schedule. (These steps will depend on the programming device.) This chapter only describes all of the weld functions available for use in programming a weld schedule.

What is a Weld Schedule?

.

A weld *schedule* is a list of commands that the control is to execute. For example, to perform a simple spot weld, you might use a weld schedule consisting of the following functions:

```
LINEAR STEPPER #2 ASSIGNED  
TURN ON WELD SOLENOID #1  
TURN ON ISOLATION CONTACTOR  
SQUEEZE 20 CYCLES  
WELD 10 CY 50% I  
HOLD 02 CYCLES  
WAIT FOR NO INITIATE IF FAULT  
TURN OFF WELD SOLENOID #1  
TURN OFF ISOLATION CONTACTOR
```

Software Capabilities

.

The MedWeld 3005 provides commands for:

- Assigning a schedule to a stepper,
- Defining the type of stepper to use (linear or SureWeld),
- Turning selected outputs on or off and
- Providing weld current.

Other functions enable

- Overriding the setup parameters,
- Controlling the I/O by monitoring inputs and activating outputs,
- Regulating weld current to fall within a prescribed range, and repeat the weld if the current is not within that range,
- Statistical process control (SPC) functions,
- Selecting the firing mode (to assure consistent voltage or to assure constant secondary current) and
- Pausing in a schedule to wait for certain operating conditions to become true.

Add or delete functions from this list, or change any of the numeric values specified in a function. This lets you create a schedule that meets your application requirements.

The following sections describe the functions available for use in a weld schedule, including the two-digit function code and the action each function produces.

The functions are grouped according to their purpose in a weld schedule, and to aid your understanding their overall interaction.

List of Functions

.

NOTE: *Unless otherwise indicated, **nn** represents any two-digit number from 0 – 99. **nnn** is a 3-digit number from 0 – 999. Exceptions to this convention will appear next to the function.*

Delay Functions

Delay functions all have the same effect on the weld schedule: They cause the control to wait for the number of cycles specified. (Different names are assigned for describing the reasons for a delay.)

During these functions, weld current does not flow and I/O status is not changed.

- 01 SQUEEZE nn CYCLES
- 02 COOL nn CYCLES
- 03 HOLD nn CYCLES
- 04 OFF nn CYCLES
- 05 INITIAL SQUEEZE nn CYCLES
- 07 WAIT nn CYCLES

Weld Functions and Firing Modes

Weld functions provide a specified amount of weld current for the number of cycles programmed. The function selected also selects the type of firing mode desired.

The weld function you select also tells the weld processor the type of firing mode to use to control the energy provided to a weld. Specify weld current as either

- A percentage of maximum available current, or
- The amount of secondary current.

This function tells the control how to compensate for changes in the welding environment:

- **%I** uses a feature called **Automatic Voltage Compensation**. AVC monitors *primary voltage*, using a nominal voltage reference point (programmed in the setup parameters) to determine when compensation is required for voltage swings on the weld bus. This method does NOT compensate for changes in the welder secondary circuit.
- **Automatic Current Compensation** ACC monitors the *current* during each cycle. It compensates for changes detected during the next cycle, to maintain secondary current at the level programmed.

Functions using the AVC firing mode specify weld current as nn%I (representing the *percentage of maximum available* current). Functions using the ACC firing mode specify a set amount of *secondary current*, displayed as **nnnn0 AMPS**.



Caution:

The Transformer Turns Ratio setup parameter (described on page 6-13) must be accurately programmed for the control to supply the correct amount of secondary current in ACC firing mode.

NOTE:

The weld data generated by the control (and displayed at the DEP or a data monitoring device) does NOT include every function that provides weld current. Keep this in mind when programming a weld schedule. Only the following functions are included in the Weld Data display:

AVC Firing Mode (%I)

- 20 WELD nn CY/IMP mm %I *
- 21 TEMPER nn CY/IMP mm %I
- 22 PREHEAT nn CY/IMP mm %I
- 23 POSTHEAT nn CY/IMP mm %I
- 24 PRE-WELD nn CY/IMP mm %I
- 25 WELD nn CY/IMP mm.m %I *
- 26 WELD nn HALF CYCLES mm.m %I *

* The stepper is active during this function. Functions #20–26 select the AVC firing mode.

NOTE:

For all weld functions, mm = 20 – 99. (The processor can fire a range from 20% to 99% I.) For half-cycle functions, the range is from 20.0% to 99.9% I. AVC faults may occur when the control is firing at or near the upper and lower limits (20 and 99%).

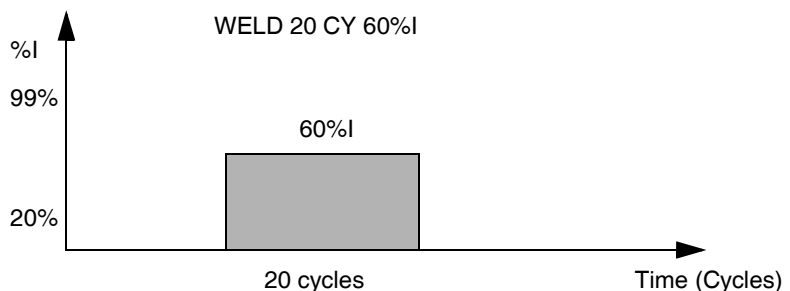

NOTE: When Function #60 appears before any weld function in a schedule, the control displays **IMP** (impulses) rather than **CY** (cycles) to indicate the weld control will **pulsation** weld. Refer to Function #60 on page 4-7 for more information.

Automatic Current Compensation Firing Mode

The following weld functions will select the Automatic Current Compensation (ACC) firing mode.

- 30 WELD nn CY/IMP nnnn0 AMPS*
- 31 TEMPER nn CY/IMP nnnn0 AMPS
- 32 PREHEAT nn CY/IMP nnnn0 AMPS
- 33 POSTHEAT nn CY/IMP nnnn0 AMPS
- 34 PRE-WELD nn CY/IMP nnnn0 AMPS

* The stepper is active during this function.

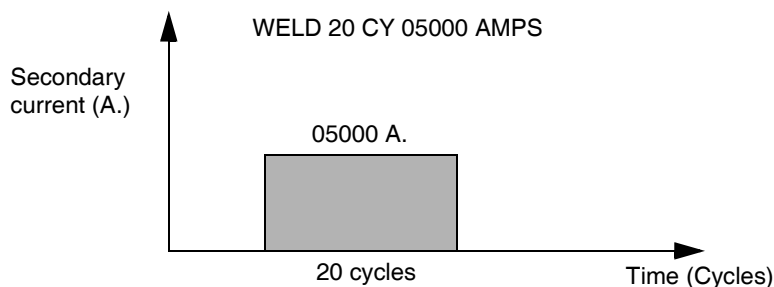

NOTES: ACC faults may occur when the control is firing at or near the high and low range of current. The current range for each control is unique and depends on factors such as the size of the weld transformer. Experiment with the control to determine the upper and lower range of current each control can provide.

When Function #60 appears before any weld function in a schedule, the control displays **IMP** (impulses) rather than **CY** (cycles) to indicate that the weld control will **pulsation** weld. See Function #60 on page 4-7 for more information.

When monitoring secondary current, the minimum “no-weld” current for the selected current range will be used for ACC and stepper increment. This is versus the 16 A. no-weld current used when monitoring primary current. The SCIB minimum “no-weld” cycle currents for 25 kA., 50 kA. and 100 kA. jumper settings are 300, 600 and 1200 A., respectively.

Other Functions Controlling Weld Current

Note: For all weld functions, $mm = 20 - 99$. The processor can fire a range from 20% to 99% I.

40 SLOPE nn CY mm %I TO mm %I

45 SLOPE nn CY nnnn0 AMPS TO nnnn0 AMPS

These functions provide weld current that starts at the first value and increase or decreases linearly to the second value over the number of cycles specified.

Either function will fire for the number of cycles specified. For example, the function

40 SLOPE 30 CY 45% I TO 65% I

tells the control to fire one cycle at 45% of the maximum available current. Then, over the next 29 cycles, gradually increase the heat provided to 65%.

NOTE: *The processor can fire a range from 20% to 99% I. AVC faults may occur when firing at or near these ranges.*

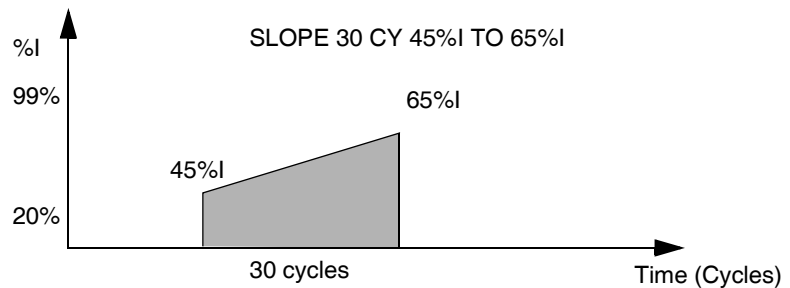

However, by defining the slope as an *impulse* (Function #60 appears before this function in the schedule), the weld processor gradually increases the energy provided by each impulse, until it has sloped to the desired energy.

For example, the following two functions will have the action shown in the diagram below

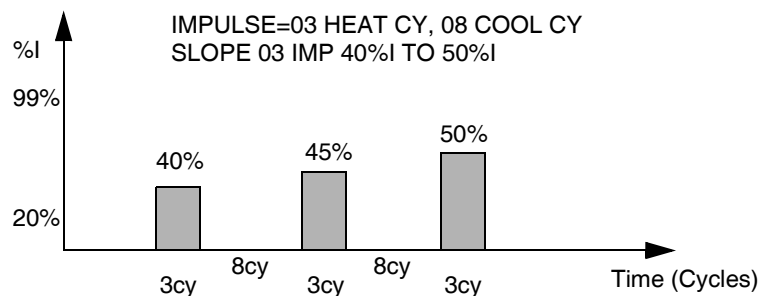

60 IMPULSE= nn HEAT CY, nn COOL CY (*nn=1-99*)

This function defines the length of a weld impulse. It tells the weld processor that the next function in the schedule should pulsation weld (providing heat cycles followed by cool cycles, rather than just heat cycles).

When this function appears before any weld function, the control displays IMP (impulse) rather than CY (cycles) to indicate the weld control will pulsation weld.

Pulsation welding provides a specified number of impulses. (An impulse is a number of heat cycles—when weld current flows—followed by a number of cycles when current does not flow.) Consider the following schedule:

```
60 IMPULSE = 10 HEAT CY, 10 COOL CY
20 WELD 04 IMP 65%I
```

In this example, the weld processor will actually fire for 10 cycles at 65% heat, then wait for 10 cycles with NO heat, *and repeat this pattern 4 times.*

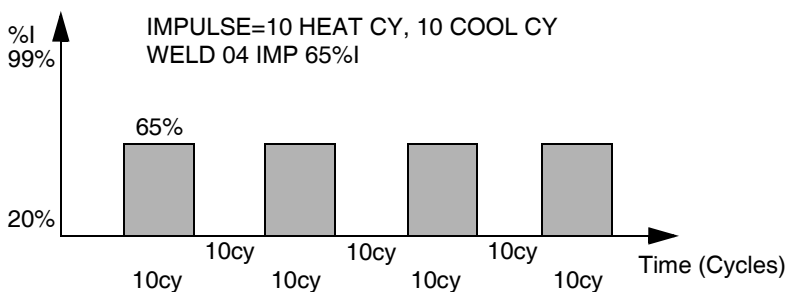

This function only affects the next function in a weld schedule. It should appear before every weld or slope function you want to pulsation weld in the schedule.

74 WELD nnn IMP mm %I HIGH mm %I LOW (*nn=1-999 mm=20-99*)

Function #74 enables welding at two different heat settings. It **MUST** immediately follow Function #60 (which defines the length of the impulse) in the weld schedule.

The control uses the first current setting (*nn %I HIGH*) for the heat cycles of the impulse. The second heat setting (*nn %I LOW*) defines the amount of heat to provide during the cool cycles of an impulse.

The cool cycles actually fire at a reduced % heat. For example, the following schedule will have the action illustrated here:

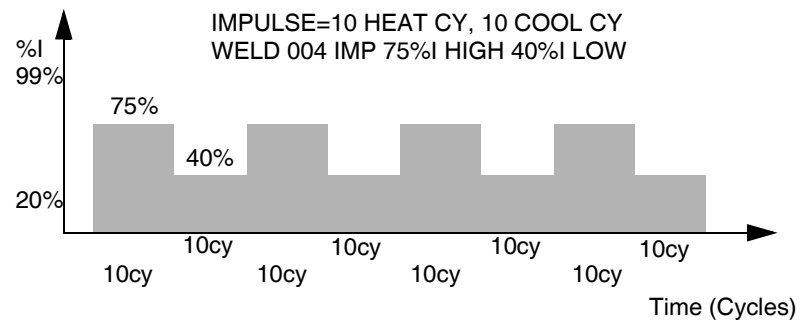

Output Control Functions

Note: These functions require certain outputs. Before programming these functions, check the packet of drawings that came with your control for I/O availability.

These functions allow the control to turn outputs on or off within a weld schedule.

- 50 TURN ON WELD COMPLETE
- 51 TURN OFF WELD COMPLETE
- 52 TURN ON ISOLATION CONTACTOR
- 53 TURN OFF ISOLATION CONTACTOR
- 54 TURN ON VALVE #n ($n = 1-6$)
- 55 TURN OFF VALVE #n ($n = 1-6$)
- 56 TURN ON PRESSURE SELECT #n ($n = 1-4$)
- 57 TURN OFF PRESSURE SELECT #n ($n = 1-4$)
- 58 TURN ON WELD IN PROGRESS
- 59 TURN OFF WELD IN PROGRESS
- 63 TURN ON OUTPUT #n ($n = 1-8$)
- 64 TURN OFF OUTPUT #n ($n = 1-8$)

NOTES:

The function TURN ON WELD COMPLETE will only activate the WELD COMPLETE output under the following conditions: There are no active fault conditions, AND the BINARY SELECT or WELD INITIATE inputs are still active.

Function #52 (TURN ON ISOLATION CONTACTOR) will first check to determine if the isolation contactor is already closed, and will pull in the isolation contactor only if it is open. This is designed to improve the process speed, bypassing the delay provided to wait for the isolation contactor to close.

Input Monitoring Functions

Note: These functions require certain inputs. Before programming these functions, check the packet of drawings that came with your control for I/O availability.

- 65 WAIT nnn CY FOR INP #m TO BE #p (0=OFF, 1=ON) (*m = 1-8 p = 0-1*)
- 66 WAIT FOR INPUT #m TO BE p (0=OFF 1=ON) (*m = 1-8 p = 0-1*)
- 68 WAIT nnn CY FOR PRESSURE SWITCH INPUT
- 69 WAIT FOR PRESSURE SWITCH INPUT
- 70 WAIT nnn CY FOR WELD PROCEED INPUT
- 71 WAIT FOR WELD PROCEED INPUT
- 72 WAIT nnn CY FOR LINE > nnn VOLTS
- 73 WAIT FOR LINE > nnn VOLTS
- 79 WAIT nnn CY FOR SYSTEM COOLING

These functions tell the control to check the status of an input. They wait either indefinitely for an input to be active, or wait for only a specified number of cycles for the input to be active.

If the input does not become active within the specified delay, the processor generates the appropriate fault condition, as listed below. (The wait functions with no programmable delay will abort the schedule and generate the fault if the initiate is removed while the weld processor is waiting.)

- Functions #65 and #66: WELD PROCEED fault. Function #65 will wait in the sequence for up to the specified number of cycles, **nnn** for a given input to become either activated or deactivated. Function #66 waits indefinitely.

Function #65 continues the sequence in No Weld mode to inhibit weld current from flowing if the Weld Proceed setup parameter is programmed as a FAULT. If this parameter is programmed as an ALERT or as NONE, it continues with the sequence as normal.

- Functions #68 and #69: PRESSURE SWITCH fault. Function #68 waits in the sequence for up to the specified number of cycles, **nnn**. Function #69 waits indefinitely.

Function #68 continues the sequence in No Weld mode to inhibit weld current from flowing if the Pressure Switch setup parameter is programmed as a FAULT. If programming this parameter as an ALERT, it continues with the sequence as normal.

- Functions #70 and #71: WELD PROCEED fault. Function #70 pauses and waits for up to the specified number of cycles **nnn** for the WELD PROCEED input to become active. Function #71 operates the same way, but will wait indefinitely.

Function #70 continues the sequence in No Weld mode to inhibit weld current from flowing if the Weld Proceed setup parameter is programmed as a FAULT. If this parameter is programmed as an ALERT, it continues with the sequence as normal.

- Functions #72 and 73: INSUFFICIENT LINE VOLTAGE fault. Function #72 will wait in the sequence for up to the specified number of cycles, **nnn** for the WELD PROCEED input to become active. Function #73 waits indefinitely.

Function #72 continues the sequence in No Weld mode to inhibit weld current from flowing if the Insufficient Line Voltage setup parameter is programmed as a FAULT. If programming this parameter as either an ALERT or NONE, it continues with the sequence as normal.

- Function #79: SYSTEM COOLING fault. (As a safety measure, the control cycles in No Weld to inhibit weld current from flowing.)



Caution:

DO NOT confuse the **label** used by the weld function (Input #1, for example) with an **actual input** position. That is, User Input #1 is NOT NECESSARILY assigned to input #1.

85 WAIT FOR NO INITIATE IF FAULT

This function tells the control to check if any faults exist. If the output is de-energized (a fault condition is present), the control waits 10 cycles in the weld schedule for the weld initiate to be removed. This function should appear after Function #78 (PROCESS WELD FAULTS) in the weld sequence.

If the initiate is still present after 10 cycles, the control uses the NO ZERO CROSSING SYNCHRONIZATION Fault to indicate that a fault condition was active. (This is to prevent the control from performing a repeat of the sequence after receiving a fault reset signal.)

Extend/Repeat Functions

Note: These functions require certain inputs. Before programming these functions, check the packet of drawings that came with your control for I/O availability.

67 EXTEND WHILE INPUT #n IS #m (0 = OFF 1 = ON) (n = 1-8 m = 0-1)

This function tells the control to monitor a specific user input (#n), and to extend the *previous* function in the weld sequence while the input is either off or on. The control extends until the status of the input changes.

For example, if the function is programmed to extend while User Input #5 is 0 (OFF), the control will extend the previous function until User Input #5 turns ON.



Caution:

DO NOT confuse the **label** used by the weld function (Input #1, for example) with an **actual input** position. That is, User Input #1 is NOT NECESSARILY assigned to input #1.

75 EXTEND UNTIL NO INITIATE

This function tells the weld processor to monitor the status of the WELD INITIATE input, and to extend only *the previous function in the weld schedule* until it detects that the WELD INITIATE input is inactive.

62 REPEAT (AT NEXT FUNCTION)

This function also monitors the status of the weld initiate. When the control completes a weld schedule, it repeats the remaining functions in the schedule. At the end of the schedule, it returns to the repeat function, again checks the status of the WELD INITIATE input, and repeats the rest of the schedule. This continues *until* the processor detects that the WELD INITIATE input has been removed.

NOTE: *Functions #62 and #75 are mutually exclusive. They should NOT appear in the same sequence.*

Stepper Assignment Functions

- 82 LINEAR STEPPER #nn ASSIGNED (0 = OFF)
- 83 SUREWELD STEPPER #nn ASSIGNED (0 = OFF)
(nn = 1-99)

Function #82 assigns a linear stepper to a weld schedule. Function #83 assigns a SureWeld stepper to a weld schedule.

The MedWeld 3005 can have up to 99 independent linear steppers, and up to 99 SureWeld steppers. Linear steppers have 5 programmable levels (called “steps”) to provide additional energy. When either function appears in a weld schedule, the appropriate

stepper is advanced (incremented) each time you execute the weld schedule.

If it is used in a weld schedule, either function MUST be the *first* function in the schedule.

Valid stepper numbers are 1 – 99. To disable a stepper for a schedule, assign the stepper as zero (#0). For more details about steppers, refer to Chapter 7, “Stepper Data”.

86 TIP DRESS ADVANCE GROUP #nn STEP #M
(nn = 1-99 m = 1-5)

This function advances all the steppers assigned to the group number programmed in this function, to the step number specified in the function.

Suppose this function reads: TIP DRESS ADVANCE GROUP #02 STEP #05. Every stepper (1 – 99) assigned to group #02 would advance to Step #5.

NOTES: *This function can advance several steppers simultaneously. For example, your application may use several different weld schedules to execute a weld on the same tool, but those schedules may be assigned to different steppers (to account for weld variations).*

*This function allows you to advance every stepper assigned to a group each time **any** schedule finishes a weld. (Every time the electrodes weld, EVERY stepper involved is also advanced.)*

Program the group assignments using the Stepper Display provided from the DEP-100S. For more information, see “Linear Steppers” on page 7-2.

Functions that Override Setup Parameters

The following functions allow setting programming limits that are unique to a given weld schedule. The new limits override the limits programmed in the setup parameters, and apply only to the weld schedule where they appear. They also take priority over any other limits established.

NOTE: *Refer to “Parameter Descriptions” on page 6-2 for detailed descriptions of these limit settings as programmed in the setup parameters.*

76 SEC. CURR LIMITS: HI=nnnn0 LOW=nnnn0
 77 ISOLATION CONTACTOR DELAY=nn SEC
 90 TRANSFORMER TURNS RATIO nnn:1 (nnn=1-256)
 96 POWER FACTOR LIMIT: HI=nn% LOW=nn%
 97 C-FACTOR LIMIT: HI=nnn LO=nnn

19 KVAT LIMIT: HI=nnnn LO=nnnn (FOR T93301 ONLY)

This function defines the acceptable range of KVAT. This is the measure of actual energy applied to the weld.

84 WINDOW: HI=+ nn% LO= -nn% C-FACTOR=nnn

This function permits defining a current limit window with high and low limit values. The action of this function is based on the firing mode used by the weld function: %I or Automatic Current Compensation. For further details of this feature, refer to “Dynamic Current Windows” on page 5-4.

Test Functions

39 TEST FIRE nn% CURRENT (*nn = 20-99*)

When it executes Function #39, the control will fire one cycle of weld current at the percentage of maximum available current programmed.

The control monitors and records both the actual current and the power factor during that cycle.

The control uses this test fire to determine the initial secondary resistance of the weld, and whether the electrodes tips were touching, based on current draw. Other functions (described below) also use the data generated by the test fire.

91 FAULT IF TIPS TOUCHING

This function generates a fault condition if the test fire from Function #30 (above) determined that the welding electrodes were touching.

These conditions must be true when using this function:

- Function #39 (TEST FIRE nn% CURRENT) MUST appear in the weld sequence.
- Function #91 must appear after the test fire function (#39) in the weld sequence.
- Function #92 (FAULT IF TIPS NOT TOUCHING) cannot appear in the weld sequence.

When it executes Function #39, the control monitors the actual weld current. If the control detected *more than* 10 A. primary current, it assumes that the electrode tips *were* touching and generates a TIPS TOUCHING Fault.



Caution:

If Function #39 appears more than once in a sequence, the control uses the data from the most recently-executed test fire.

92 FAULT IF TIPS NOT TOUCHING

This function can generate a fault condition if the control determines that the welding electrodes are NOT touching.

These conditions MUST be true when using this function:

- Function #39 (TEST FIRE nn% CURRENT) must appear in the weld sequence.
- Function #92 must appear after the test fire function (#39) in the weld sequence.
- Function #91 (FAULT IF TIPS TOUCHING) cannot appear in the weld sequence.

When Function #39 executes, the actual weld current during that one cycle weld is monitored. If *less than* 10 A. primary current is detected, the control assumes that the electrode tips were NOT touching. It generates a TIPS NOT TOUCHING fault.

93 INITIAL PF LIMIT: HI=nn% LOW=nn%

This function is used to generate a fault condition if the initial power factor read during the test fire function (#39) does not fall within the high and low limits programmed in this function.

The following conditions must be true when using this function:

- Function #39 must appear in the weld schedule.
- This must appear after the test fire function (#39) in the weld schedule.

If the power factor read during the test fire was not within the range programmed, the control generates an INITIAL P.F. OUT OF RANGE fault.

98 GOTO SEQ#mm IF CURRENT LESS THAN nnnn0 (mm = 1-99)

This function determines if the current provided during the weld portion of the schedule will be sufficient to make a good weld.

These conditions must be true when using this function:

- Function #39 must appear in the weld schedule and
- This function must appear after the test fire function (#39) in the weld schedule.

NOTE: *Function #98 may appear in a schedule more than once, to allow setting-up for different welding requirements.*

An example appears in the following schedule of functions. (*This is NOT a recommended weld schedule. Your application requirements may vary.*)

```

START OF SCHEDULE #01
54  TURN ON VALVE #1
01  SQUEEZE 15 CYCLES
39  TEST FIRE 25% CURRENT
98  GOTO SEQ#02 IF CURRENT LESS THAN 02500
98  GOTO SEQ#03 IF CURRENT LESS THAN 03500
30  WELD 08 CY. 04000 AMPS
03  HOLD 02 CYCLES
55  TURN OFF VALVE #1
03  HOLD 10 CYCLES
END OF SCHEDULE #01

```

When Function #39 executes, if the current detected is less than the value programmed, the control will jump to the GOTO schedule number to complete that weld schedule. (The control will not return to complete the original weld schedule.)

NOTES:

Phase shift during test fire will NOT vary by voltage compensation. The reported current will be extrapolated to what the value of current would have been delivered, using the following calculation:

$$\text{Current Reported} = \frac{\text{Current Measured} \times \text{Nominal Voltage}}{\text{Measured Voltage}}$$

This is implemented because the test fire is a single-cycle pulse, and the control is monitoring only changes in resistance (rather than changes in current).

80 VERIFY TIPS DOWN EVERY nn CY nn TIMES

This function lets you verify that the electrode tips are making full contact with the work piece, using the control's dynamic squeeze capabilities.

During this function, the control fires one cycle of weld current at the percent entered for the Tips Down Test Fire setup parameter, then monitors the weld current provided and the power factor.

This is compared to the value programmed in the Tips Down Verified Current setup parameter, (described on page 6-13). If the primary current detected *exceeds* the value programmed, the control proceeds to the next function in the weld schedule.

If the current is *less* than the value programmed, the control waits for the number of cycles programmed (nn CY), then repeats the test

fire. This wait-and-fire process continues up to the programmed number of tries (nn TIMES).

If the current never reaches the value programmed, the control generates a TIPS NOT TOUCHING fault and schedules in No Weld. (Refer to “Dynamic Squeeze Features” on page 5-7.)

81 SLOW CYLINDER TEST EVERY nn CY nn TIMES

This function is similar to the previous function (VERIFY TIPS DOWN), but reports a different fault. It will schedule in Weld mode even when it detects a fault.

If the primary current detected by the control *exceeds* the Tips Down Verified Current: nnnn setup parameter, it proceeds to the next function in the weld schedule.

If the current is *less than* the setup parameter, the control waits the number of cycles programmed (nn CY), then repeats the test fire.

If the current never reaches the setup parameter limit, the control will continue the schedule in Weld mode, but generates a SLOW CYLINDER fault to indicate the condition.

Special Functions

94 EXTEND WELD IF LOW CURRENT LIMIT FAULT

This function tells the weld processor to automatically repeat the weld function if it detects a LOW CURRENT LIMIT fault.

This function must appear immediately after the PROCESS WELD FAULTS function in the schedule. If it detects the LOW CURRENT LIMIT fault, the control restarts the weld schedule and generates the EXTEND WELD fault/alert condition.

The control will repeat the schedule *only once*. If the desired current is not provided on the re-weld, the control generates a LOW CURRENT LIMIT fault/alert condition.

95 EXTEND WELD IF CURRENT LESS THAN nnnn0 AMPS

This function has the same result as Function #94, but monitors *secondary current* instead of the LOW CURRENT LIMIT fault.

If the secondary current provided during the schedule does not reach the minimum value programmed, the control restarts the weld schedule and generates the REWELDED fault or alert condition.

The control will repeat the schedule *only once*. If the desired current is not provided on the re-weld, the control generates a REWELDED fault.

NOTE:

When it is in No Weld mode, the control bypasses these Extend Weld functions. (The weld processor will not monitor the amount of current provided, because the control is in No Weld.)

78 PROCESS WELD FAULTS

This function provides a one-cycle delay in the weld schedule. It asks the MedWeld 3005 to indicate any faults that may have been generated so far in the schedule.

The control normally processes all fault conditions at the *end* of the weld schedule. This function allows forcing the control to process fault conditions before it completes the weld schedule. It should appear in the weld schedule **BEFORE** any functions that check fault status or require current weld data.

Cautions:

This function also causes the control to calculate the voltage, current and power factor averages and the C-factor for the weld. It also terminates the weld summary data collection, to assure the integrity of the weld data collected.



This function only processes the weld data: It does **NOT** update the **FAULT** and **ALERT** outputs. These outputs will be updated when the control executes the function **TURN ON WELD COMPLETE OR** at the end of the weld schedule.

This function will be executed only once by the processor. If it appears more than once in the schedule, it will be executed the **first** time it appears in the weld schedule.

89 VERIFY CYLINDER #n IS OUT OF RETRACT (*n = 1-2*)

This function tells the control to check that the selected cylinder is out of retract. If the cylinder is **NOT** out of retract, the control will abort the schedule and generate a **RETRACT PILOT** fault.

61 ABORT IF NO INITIATE FOR nn CYCLES

This function tells the control to verify that the weld initiate has remained active. The control waits the number of cycles programmed while checking the initiates. If the initiates are not present at any time while it is waiting, the control will abort the sequence and generate the **WELD INITIAT NOT PRESENT** fault.

99 GOTO SEQ#nn (nn = 1-99)

This function is an unconditional jump to another weld schedule. It tells the control to stop the present weld schedule, and continue with the first function in another schedule.

This function can be used to save memory space in the control, by allowing multiple schedules to execute commonly-used functions.

The control considers the schedule *originally* initiated as the last schedule. The stepper assigned to the original schedule is also the only one incremented. This function should appear as the *last* function in a schedule, because the control will not return to the original schedule when it completes the new schedule.

**Caution:**

It is possible to create an infinite programming loop with Functions #98 (GOTO SEQ #nn IF CURRENT LESS THAN nnnn0 AMPS) and #99.

SPC Indexing Functions

The following functions permit collecting weld data for use in SPC (Statistical Process Control) Indexing. Refer to “SPC Indexing Capabilities” on page 5-9 for a detailed description of the control’s SPC capabilities.

87 SET SPC OFFSET TO nn

This function establishes the starting bin number for SPC indexing. Bin #99 is the last usable bin. If the control reaches bin #99 and is still collecting data, data from each weld will be stored in bin #99 until a new offset is assigned. As a result, data accumulated in this bin is unsuitable for analysis.

NOTE:

This function does NOT tell the control to collect weld data. It only assigns a data storage bin number. Refer to the Data Collection Sample Size and Data Collection Sample Frequency setup parameters on page 5-10 for instructions on how to specify data collection.

88 SEND ALL SAMPLES UNTIL NEXT SPC OFFSET

This function tells the control to start collecting weld data for all welds. This function should follow the SPC OFFSET function in the weld schedule because it is still necessary to assign a starting bin number.

Weld data collection continues until the control executes another schedule containing the SPC OFFSET function (without *this* function), to reset the global data collection process.

This function *overrides* the global Data Collection Sample Size and Data Collection Sample Frequency setup parameters described on page 5-10.



Caution:

This function is not designed for use in a normal production run. It is intended for special situations (such as tear-down) which require continuous data collection.

Cascade Firing

Programs #T93300-17 and greater will support for firing multiple contactors from a single phase supply. A Cascade Firing Board (CFB) installed in the control allow the switch of one firing signal to multiple SCR units. To used this feature you insert Function 10 TURN ON CONTACTOR SELECT & Function 11 TURN OFF CONTACTOR SELECT into the welding schedule.

NOTE:

There must be a MINIMUM of 5 cycles delay programmed after turning ON any CONTACTOR SELECT prior to any weld current statement. This time is embedded into the Turn On Contactor Select after software T93300-00-18

10 TURN ON CONTACTOR SELECT #nn (nn=1 - 15)

This function selects the SCR number to enable for firing. This function also allows you to set multiple limit and transformer settings through an individual schedule.

You can only select one SCR at a time. If no SCR is selected in the schedule, the default SCR (1) will be enabled.

Danger!



If any two SCRs are selected at the same time, Catastrophic damage to the unit will occur. This is protected in the hardware of the CFB when properly installed.

When using Function 10, this function should precede any stepper assignments function, current limit function, etc. that will be used for this contactor.

11 TURN OFF CONTACTOR SELECT #nn (nn=1 - 15)

This function turns off the contactor select allowing a new SCR to be selected. Also this function terminates the weld data collection for this weld.

NOTE: *In the DEP100s Weld Data Screen, the up arrow will allow the user to scroll through the individual welds made in a single schedule. This screen continually updates, if another weld is made the DEP will load the new information.*

Analog Pressure Control Functions

Programs #T-93300-19 and greater will support analog I/O through an analog card in the SLC rack. To implement this support, four new functions have been added to this version. For all these functions, pressure channel #1 corresponds to the SLC Analog card channel #0. Pressure channel #2 corresponds to Analog channel #1.

08 SET VALVE *n* CYLINDER PRESSURE TO *mm* PSI
(*n* = 1,2; *m* = 0–99)

This function sets the final pressure that the cylinder for either weld gun must achieve before welding begins.

n is the weld gun number, either 1 or 2. Set the final pressure *mm* in the range 0 – 99 PSI.

09 WAIT *nn* CYCLES FOR PRESSURE ACHIEVED
(*nn* = 0–99)

This function tells the control to pause in a weld sequence until it detects that the valve pressure programmed (in Functions #08, #13 and #14) has been achieved.

Set the number of cycles *nn* in the range 0 – 99.

If more than one valve pressure setting is in a sequence, this function monitors only the *last* pressure function it sees.

If the valve pressure is not achieved after the programmed number of cycles, the control generates a PRESSURE NOT ACHIEVED condition. If the Pressure Not Achieved setup parameter is programmed to generate a FAULT, the control continues with the sequence in No Weld mode to inhibit weld current from flowing. If programming this parameter as an ALERT or NONE, it continues with the sequence as normal.

13 SET VALVE *n* TOUCH DOWN PRESSURE TO *mm* PSI
(*n* = 1,2; *m* = 0–99)

This function sets a reduced “touch down” pressure for the weld gun to approach and initially touch the work pieces, prior to clamping them and applying the final pressure before welding. This prevents the weld gun from closing too fast and hard on the work pieces.

n sets the cylinder number: Either #1 or #2. Set the pressure *mm* in the range 0 – 99 PSI.

14 SET VALVE *n* TIP DRESS RESSURE (PSI)
(*n* = 1,2; *m* = 0–99)

This function sets a pressure for the specified weld gun that can be different from the welding or “touch down” pressure settings. This is used when running tip dress schedules.

n sets the cylinder number: Either #1 or #2. Set the pressure *mm* in the range 0 – 99 PSI.

Quick Reference

.

The following list provides a quick reference for functions and the two-digit code assigned. They are grouped functionally:

Delay Functions (pg. 4-3)	01	SQUEEZE <i>nn</i> CYCLES
	02	COOL <i>nn</i> CYCLES
	03	HOLD <i>nn</i> CYCLES
	04	OFF <i>nn</i> CYCLES
	05	INITIAL SQUEEZE <i>nn</i> CYCLES
	07	WAIT <i>nn</i> CYCLES
	AVC Firing Mode (pg. 4-4)	20
21		TEMPER <i>nn</i> CY/IMP <i>mm</i> %I
22		PREHEAT <i>nn</i> CY/IMP <i>mm</i> %I
23		POSTHEAT <i>nn</i> CY/IMP <i>mm</i> %I
24		PRE-WELD <i>nn</i> CY/IMP <i>mm</i> %I
25		WELD <i>nn</i> CY 00.0 %I
26		WELD <i>nn</i> HALF-CYCLES 00.0 %I
ACC Firing Mode (pg. 4-5)	30	WELD <i>nn</i> CY/IMP <i>nnnn</i> 0 AMPS*
	31	TEMPER <i>nn</i> CY/IMP <i>nnnn</i> 0 AMPS
	32	PREHEAT <i>nn</i> CY/IMP <i>nnnn</i> 0 AMPS
	33	POSTHEAT <i>nn</i> CY/IMP <i>nnnn</i> 0 AMPS
	34	PRE-WELD <i>nn</i> CY/IMP <i>nnnn</i> 0 AMPS
	36	WELD <i>nn</i> HALF-CYCLES <i>nnnn</i> 0 AMPS

Other Functions Providing Weld Current (pg. 4-6)	40	SLOPE nn CY (IMP) mm% TO mm% I
	45	SLOPE nn CY nnnn0 AMPS TO nnnn0 AMPS
	60	IMPULSE = nn HEAT CY, mm COOL CY
	74	WELD nnn IMP nn% HIGH nn% LOW
Output Control Functions (pg. 4-8)	50	TURN ON WELD COMPLETE
	51	TURN OFF WELD COMPLETE
	52	TURN ON ISOLATION CONTACTOR
	53	TURN OFF ISOLATION CONTACTOR
	54	TURN ON VALVE #n
	55	TURN OFF VALVE #n
	56	TURN ON PRESSURE SELECT #n
	57	TURN OFF PRESSURE SELECT #n
	58	TURN ON WELD IN PROGRESS
	59	TURN OFF WELD IN PROGRESS
Input Monitoring Functions (pg. 4-9)	63	TURN ON OUTPUT #n
	64	TURN OFF OUTPUT #n
	65	WAIT nnn CY FOR INP #m TO BE #p (0=OFF, 1=ON) (<i>m = 1-8 p = 0-1</i>)
	66	WAIT FOR INPUT #m TO BE #p (0=OFF, 1=ON) (<i>m = 1-8 p = 0-1</i>)
	68	WAIT nnn CY FOR PRESSURE SWITCH INPUT
	69	WAIT FOR PRESSURE SWITCH INPUT
	70	WAIT nnn CY FOR WELD PROCEED INPUT
	71	WAIT FOR WELD PROCEED INPUT
	72	WAIT nnn CY FOR LINE > nnn VOLTS
	73	WAIT FOR LINE > nnn VOLTS
79	WAIT nnn CY FOR SYSTEM COOLING	
85	WAIT FOR NO INITIATE IF FAULT	
Extend/Repeat Functions (pg. 4-10)	67	EXTEND WHILE INPUT #n IS #m (0 = OFF 1 = ON) (<i>n = 1-8 m = 0-1</i>)
	75	EXTEND UNTIL NO INITIATE
	62	REPEAT (AT NEXT FUNCTION)
Stepper Assignment Functions (pg. 4-11)	82	LINEAR STEPPER #nn ASSIGNED (0 = OFF)
	83	SUREWELD STEPPER #nn ASSIGNED (0 = OFF)
	86	TIP DRESS ADVANCE GROUP #nn STEP #m (<i>nn = 1-99 m = 1-5</i>)

Functions that Override Setup Parameters (pg. 4-12)	19	KVAT LIMIT: HI=nnnn0 LOW=nnnn0
	76	SEC. CURR LIMITS: HI=nnnn0 LOW=nnnn0
	77	ISOLATION CONTACTOR DELAY=nn SEC
	84	WINDOW: HI=+ nn% LO= -nn% C-FACTOR=nnn
	90	TRANSFORMER TURNS RATIO NNN:1 (NNN=1-256)
	96	POWER FACTOR LIMIT: HI=nn% LOW=nn%
	97	C-FACTOR LIMIT: HI=nnn LO=nnn
Test Functions (pg. 4-13)	39	TEST FIRE nn% CURRENT (<i>mm = 20-99</i>)
	80	VERIFY TIPS DOWN EVERY 00 CY mm TIMES
	81	SLOW CYLINDER TEST EVERY 00 CY mm TIMES
	91	FAULT IF TIPS TOUCHING
	92	FAULT IF TIPS NOT TOUCHING
	93	INITIAL PF LIMIT: HI= nn% LOW = nn%
	98	GOTO SEQ#mm IF CURRENT LESS THAN nnnn0
Special Functions (pg. 4-16)	94	EXTEND WELD IF LOW CURRENT LIMIT FAULT
	95	EXTEND WELD IF CURRENT LESS THAN nnnn0 AMPS
	99	GOTO SEQ #nn
	78	PROCESS WELD FAULTS
	89	VERIFY CYLINDER #N IS OUT OF RETRACT (<i>n = 1-2</i>)
	78	PROCESS WELD FAULTS
	80	VERIFY CYLINDER #0 IS OUT OF RETRACT
SPC Index Functions (pg. 4-18)	87	SET SPC OFFSET TO nn
	88	SEND ALL SAMPLES UNTIL NEXT SPC OFFSET
Cascade Firing (pg. 4-19)	10	TURN ON CONTACTOR SELECT nn
	11	TURN OFF CONTACTOR SELECT nn
Analog Pressure Control Functions (pg. 4-20)	08	SET VALVE n CYLINDER RESSURE TO mm PSI
	09	WAIT nn CYCLES FOR PRESSURE ACHIEVED
	13	SET VALVE n TOUCH DOWN RESSURE TO mm PSI
	14	SET VALVE n TIP DRESS RESSURE (PSI)

Default Weld Schedule

.

Following is the default sequence for program #T93300-00-1:

Default Weld
Sequence:
Machine

```

START OF SEQUENCE #nn
82  LINEAR STEPPER #00 ASSIGNED (0 = OFF)
76  SEC CURR LIMITS: HI=0000 LO=9999
90  TRANSFORMER TURNS RATIO: 100:1
58  TURN ON WELD IN PROGRESS
52  TURN ON ISOLATION CONTACTOR
01  SQUEEZE 30 CYCLES
30  WELD 10 CY. 0050 AMPS
78  PROCESS WELD FAULTS
03  HOLD 05 CYCLES 50TURN ON WELD COMPLETE
59  TURN OFF WELD IN PROGRESS
75  EXTEND UNTIL NO INITIATE
51  TURN OFF WELD COMPLETE
53  TURN OFF ISOLATION CONTACTOR
END OF SEQUENCE # nn
    
```

Default Weld
Sequence: Robot

```

START OF SEQUENCE #nn
82  LINEAR STEPPER #0 ASSIGNED (0 = OFF)
88  TURN ON ISOLATION CONTACTOR
50  TURN ON PRESSURE SELECT #1
52  TURN ON WELD SOLENOID #1
01  SQUEEZE 12 CYCLES
72  WAIT 000 CY FOR LINE > 440 VOLTS
24  EXTEND WELD 00 CY. 30%
02  COOL 00 CYCLES
20  WELD 10 CY. 50%
03  HOLD 10 CYCLES
53  TURN OFF WELD SOLENOID #1
51  TURN OFF PRESSURE SELECT #1
85  PROCESS WELD FAULTS
54  TURN ON EWS OUTPUT
75  EXTEND UNTIL NO INITIATE
55  TURN OFF EWS OUTPUT
89  TURN OFF ISOLATION CONTACTOR
END OF SEQUENCE #nn
    
```

Tip Dress Sequence
14

```

START OF SEQUENCE #nn
52  TURN ON WELD SOLENOID #1
01  SQUEEZE 12 CYCLES
53  TURN OFF WELD SOLENOID #1
54  TURN ON EWS OUTPUT
14  DELAY (5 CYCLES)
55  TURN OFF EWS OUTPUT
90  TIP DRESS ADVANCE: STPR GROUP 1 – STEP 2
END OF SEQUENCE #nn
    
```

Tip Dress Sequence
#15

START OF SEQUENCE #nn
 52 TURN ON WELD SOLENOID #2
 01 SQUEEZE 12 CYCLES
 53 TURN OFF WELD SOLENOID #2
 54 TURN ON EWS OUTPUT
 14 DELAY (5 CYCLES)
 55 TURN OFF EWS OUTPUT
 90 TIP DRESS ADVANCE: STPR GROUP 2 – STEP 2
 END OF SEQUENCE #nn

Default Weld
Sequence: Manual/
Portable Gun

START OF SEQUENCE #nn
 82 LINEAR STEPPER #01 ASSIGNED (0 = OFF)
 76 SEC CURR LIMITS: HI=00000 LO=99990
 90 TRANSFORMER TURNS RATIO: 100:1
 54 TURN ON VALVE #1
 05 INITIAL SQUEEZE 25 CYCLES
 62 REPEAT (AT NEXT FUNCTION)
 54 TURN ON VALVE #1
 01 SQUEEZE 30 CYCLES
 30 WELD 10 CY. 00050 AMPS
 78 PROCESS WELD FAULTS
 03 HOLD 05 CYCLES
 55 TURN OFF VALVE #1
 04 OFF 20 CYCLES
 END OF SEQUENCE # nn

Advanced Software Features 5

This chapter describes some of the advanced features of the MedWeld 3005 control.

C-Factor

.

C-Factor is the value of current obtained for each *change* in percentage of the maximum secondary current delivered. C-Factor equals 1% of the total available current during a weld.

The C-Factor can be used in various ways:

- It can be used as a conversion factor between %I values and the actual value of current that would be produced.
- A change in C-Factor will indicate changes in the welding environment.

The actual C-Factor is calculated by the MedWeld 3005 after every weld, and is displayed by the programming device in the Weld Data displays.

The processor calculates C-Factor is by dividing the average secondary current during the weld by the %I fired. The following formula shows this:

$$\text{C-Factor} = I_{\text{pri}} \times \frac{n}{\%I} \times \frac{V_{\text{nominal}}}{V_{\text{line}}} = \frac{I_{\text{sec}}}{\%I} \times \frac{V_{\text{nominal}}}{V_{\text{line}}}$$

where *n* = transformer turns ratio.

The C-Factor varies with changing conditions in the secondary. Decreasing C-Factor indicates that the total capacity of the system is decreasing. This is evident when the tool current pathways become more resistive. This, in turn, results in deterioration in the secondary circuit. (Two examples of this are cable wear and deterioration of connections.)

Example of Decreasing C- Factor

In an application of shunts in a fixture indexing gun, the guns will pull on the cable. These forces cause strands of wire in the cable to break. As fewer conducting strands remain, the current pathway will decrease, increasing the resistance. This, in turn, will decrease the C-Factor.

This is illustrated by the following data:

- The control is firing the following weld function:
WELD 10 CYC 10000 A.
- The control required 53% initially to achieve the 10,000 A. Over time, the control actually requires 60% to achieve the desired 10,000 A.
- The initial C-Factor = 10,000 A. / 53% = 189
- Final C-Factor = 10,000 A. / 60% = 167

Conversely, where C-Factor increases, the total capacity of the system is increasing. This increase in C-Factor is associated with shorting/shunting conditions in the welding environment.

When shorting or shunting arises, less resistance is seen because the full current is not passing through the entire welding circuit.

This is a concern. If the full current is not passing through the weld point, a weld below the desired current will occur. Depending on the amount of shunting, the weld nugget may possibly fail to be formed.

Example of Increasing C-Factor

In this example, a robot uses a kickless cable. The robot's motions will cause the cable to twist. As a result, individual wires within the cable will rub against each other.

This action will eventually cause the cable insulation to break down. When this breakdown occurs, the current will start to shunt between wires within the kickless cable.

As this grows, the current at the weld will diminish, and the current pathway will actually decrease. This, in turn, will increase the C-Factor.

This is illustrated by the following data:

- The weld control is firing the following function:
WELD 10 CYC 65% I
- The control initially sees 12,450 A.
- After the shorting condition occurs, the control may see 14,300 A.
- Initial C-Factor = 12,450 A. / 65% = 192.
- Final C-Factor = 14,300 A. / 65% = 220.

C-Factor can be used to alert the maintenance staff of a welder's deteriorating secondary circuit. You can establish upper and lower C-Factor limits that correspond to a current threshold, to meet the needs of the welding process.

The MedWeld 3005 also provides Function #97 (C-FACTOR LIMIT: HI=000 LO=000) to define the high and low C-Factor limits for a weld schedule. Use to determine when the welding conditions indicate the need for maintenance.

When the weld processor detects that the high or low C-Factor limits were exceeded, it activates the High or Low C-Factor Limit condition (which can be defined as either a Fault or an Alert in the setup parameters).

- Low C-Factor is a monitoring condition and usually defined as an ALERT
- High C-Factor is a welding quality issue, and usually defined as a FAULT.

Low C-Factor Limit

The low C-factor limit detects cable and connection deterioration.

Determining a Low Limit:

Suppose a weld schedule requires 14,000 A. at the end of a stepper program. However, you do not want to exceed 90% of the tool's maximum current capacity.

This means that the lowest full-current capacity of the tool should be 15,555 A. ($14000/90=155.555$). This makes the low C-Factor limit 155.

High C-Factor Limit

The high C-factor limit can detect secondary shunting paths.

Determining a High Limit

A spot weld requires 10,000 A. The maximum current achievable is 20,000 A. Then the C-Factor is 200.

However, if shunting conditions are simulated and the welds become substandard at C-Factor of 230, then the High C-Factor limit can be set to 230.

KVAT

• • • • • • • • • •

The weld processor also monitors the power delivered to a weld. This value, known as the KVAT, represents the actual power delivered to a weld. It is computed by the equation:

$$V_p \times I_p \times Cycles / 1000 = KVAT$$

Where

V_p is average primary voltage

I_p is average primary current

Cycles is number of cycles weld current.

The MedWeld 3005 provides a function to define the range of acceptable KVAT values.

19 KVAT LIMIT HIGH=0000 LOW=0000

This defines the range of KVAT that is within acceptance. The processor monitors actual KVAT, and will generate a fault condition if the actual KVAT exceeds the range specified in the weld sequence.

The High Current/KVAT Limit Fault and Low Current/KVAT Limit Fault setup parameters define the severity of the fault condition generated by the weld processor when the limits defined in Function #19 are exceeded.

Dynamic Current Windows

• • • • • • • • • •

You can define a window of acceptable values for current. To define this window, use the setup parameters: High Current Limit and Low Current Limit.

These parameters, along with the Nominal C-Factor parameter, define the acceptable range of current to expect. You can also override the values in the setup parameters by inserting into the weld schedule Function #84 (WINDOW: HI=+00% LO=00% C-FACTOR=000).

Function #84 defines a current limit window with high and low limit values and a new nominal C-Factor. (Refer to the discussion of C-Factor on page 5-1.)

The target current is determined by the firing mode used by the weld function: %I or automatic current compensation. This calculation is shown below:

AVC:

Target current =

(%I programmed in Function #20 + stepper boost) x C-Factor

ACC:

Target current =

A. programmed in Function #30 + stepper boost

Calculate the high and low current limits using this equation:

$$\text{Limit} = \text{Target current} \pm \left(\text{Target current} \times \frac{\text{HI or LO Limit percentage}}{100 \%} \right)$$

AVC Example

In this mode, the target value is determined by the following calculation:

Target current =

%I in Function #20 + Stepper boost x C-factor

An example of how these calculations are used is shown below:

- Function #20 is WELD 10 CY 50%I
- Stepper Boost is 2%
- C-Factor is 170
- High Current Limit = 10%
- Low Current Limit = 20%.

To determine the target current:

Target current =

(%I programmed in Function #20 + Stepper boost) x C-Factor

$$= (50 + 2) \times 170 = 8,840 \text{ A.}$$

To determine the High Current Limit:

High Current Limit = Target + (Target x %High Limit/100)

$$= 8,840 + (8,840 \times 10/100)$$

$$= 8,840 + (884) = 9,724 \text{ A.}$$

To determine the Low Current Limit:

$$\begin{aligned} \text{Low Current Limit} &= \text{Target} - (\text{Target} \times \% \text{Low Limit}/100) \\ &= 8,840 - (8,840 \times 20/100) \\ &= 8,840 - (1,768) = 7,072 \text{ A.} \end{aligned}$$

ACC Firing Mode

In this firing mode, the target value is established by the following calculation:

$$\text{Target current} = \text{A. in Function \#30} + \text{Stepper boost}$$

An example of how these calculations are used is shown below.

- Function #30 is WELD 08 CY 11000 A. SEC
- Stepper Boost is 700 A. SEC
- High Current Limit = 10%
- Low Current Limit = 20%

To determine the Target Current:

$$\begin{aligned} \text{Target current} &= \text{A. in Function \#30} + \text{stepper boost} \\ &= 11,000 + 700 = 11,700 \text{ A.} \end{aligned}$$

To determine the High Current limit:

$$\begin{aligned} \text{High Current Limit} &= \text{Target} + (\text{Target} \times \% \text{High limit}/100) \\ &= 11,700 + (11,700 \times 10/100) \\ &= 11,700 + (1170) = 12,870 \text{ A.} \end{aligned}$$

To determine the Low Current Limit:

$$\begin{aligned} \text{Low Current Limit} &= \text{Target} - (\text{Target} \times \% \text{Low limit}/100) \\ &= 11,700 - (11,700 \times 20/100) \\ &= 11,700 - 2,340 = 9,360 \text{ A.} \end{aligned}$$

Dynamic Squeeze Features

• • • • • • • • • •

The MedWeld 3005 provides a test fire function. Use it to determine the initial secondary resistance of a test fire, and whether the electrode tips were touching, (based on current draw).

The data generated by the test fire can be used by the control in several ways.

Specifying the Test Fire Current

First, use the setup parameter Tips Down Test Fire %I to tell the processor the amount of heat to use in the welding schedule when the control executes Function #80 (VERIFY TIPS DOWN EVERY nn CYC. nn TIMES) or Function #81 (SLOW CYLINDER TEST EVERY nn CYC. nn TIMES).

Set this parameter value to be low enough to reduce the open secondary voltage, but high enough so that the current detected when tips are down exceeds the Tips Down Verified Current setup parameter.

NOTES:

DO NOT *confuse the Tips Down Test Fire %I setup parameter with Function #39 (TEST FIRE nn%). This setup parameter is used ONLY by the VERIFY TIPS DOWN and SLOW CYLINDER TEST functions.*

Function #39 performs a 1-cycle test fire at the percent heat programmed. The test functions (described on page 5-7) use the results of this test fire to check conditions such as initial power factor and the amount of current provided by the weld.

Defining the Current Threshold

You must also define the setup parameter Tips Down Verified Current to define the current threshold to use when executing the dynamic squeeze functions: Function #80 (VERIFY TIPS DOWN nn CY. nn TIMES) or Function #81 (SLOW CYLINDER TEST EVERY nn CYC. nn TIMES).

The best way to determine this value is by experimenting to distinguish open and closed secondary currents for various heat settings.

Dynamic Squeeze Functions

Once you define the dynamic current setup parameters, use the following functions with the test fire function in a weld schedule, as described below:

80 VERIFY TIPS DOWN EVERY nn CY nn TIMES

This function uses the dynamic squeeze capabilities to verify that the electrode tips are making full contact with the workpiece. The control fires one cycle of weld current at 20%. It then monitors the weld current provided and determines the power factor.

This is compared to the value programmed in the Tips Down Verified Current setup parameter, (described on page 6-13). If the primary current detected *exceeds* the programmed value, the control proceeds to the next function in the weld schedule.

If the current is *less* than the value programmed, the control waits for the number of cycles programmed (nn CY), then repeats the test fire. This wait-and-fire process continues up to the programmed number of tries (nn TIMES).

If the current never reaches the value programmed, the control generates a TIPS NOT TOUCHING fault and sequences in No Weld.

81 SLOW CYLINDER TEST EVERY nn CY nn TIMES

This function is nearly identical to Function #80, but reports a different fault and will schedule in Weld mode even when it detects a fault.

If the primary current detected by the control *exceeds* that set in the Tips Down Verified Current: nnnn setup parameter, it proceeds to the next function in the weld schedule.

If the current is *less than* the setup parameter, the control waits the number of cycles programmed (nn CY), then repeats the test fire. If the current never reaches the setup parameter limit, the control continues the schedule in Weld Mode, but generates a SLOW CYLINDER fault to indicate the condition.

SPC Indexing Capabilities

• • • • • • • • • •

With *SPC* (Statistical Process Control) **Indexing**, the control collects weld data in temporary storage bins. This data can be collected either in controlled intervals or continuously (in special situations such as tear-down).

Analyzing the collected weld data can help recognize certain welding trends such as changes in resistance of the work piece, primary current and line voltage. You can then use the WTC XWSS (Weld Support System) to retrieve and analyze the stored data.

To perform SPC indexing, use the following functions in a weld schedule, along with the SPC setup parameters described below.

SPC Functions

87 SET SPC OFFSET TO nn

For the purpose of data collection, each weld is assigned a data storage bin number (00 – 99). This function establishes the starting bin number for SPC indexing. Here is an example:

Car Type #1:

Weld Schedule #20 - (SET SPC OFFSET TO 01)
 Weld Schedule #01 - 15 Welds Made (Bins 1–15)
 Weld Schedule #02 - 15 Welds Made (Bins 16–30)
 Weld Schedule #03 - 18 Welds Made (Bins 31–48)

Car Type #2:

Weld Schedule #21 - (SET SPC OFFSET TO 51)
 Weld Schedule #04 - 12 Welds Made (Bins 51–62)
 Weld Schedule #05 - 12 Welds Made (Bins 63–74)
 Weld Schedule #06 - 14 Welds Made (Bins 75–88)

After establishing a bin number, the program stores the data for each weld made in its own individual bin. The bin numbers increase by one each time a weld is made, until another schedule with a different offset is executed.

Bin #99 is the last usable bin. If the weld control reaches bin #99 and is still collecting data, the data for each weld will be stored in bin #99 until a new offset is assigned, therefore making the data unsuitable for analysis.

NOTE:

This function does NOT tell the control to collect weld data. It only assigns a data storage bin number. Refer to the Data Collection Sample Size and Data Collection Sample Frequency setup parameters described below for instructions on how to specify data collection.

88 SEND ALL SAMPLES UNTIL NEXT SPC OFFSET

This function tells the control to start collecting weld data for all welds. This function should follow the SPC Offset function in the weld schedule because it is still necessary to assign a starting bin number.

Weld data collection continues until the control executes another schedule containing this function (without the offset function), to reset the global data collection process.

This function *overrides* the global Data Collection Sample Size and Data Collection Sample Frequency setup parameters. These are described next.



Caution:

This function is NOT designed for use in a normal production run. It is intended for special situations (such as tear-down) which require continuous data collection.

SPC setup
Parameters

DATA COLLECTION SAMPLE SIZE: 05 (1–99)
DATA COLLECTION SAMPLE FREQUENCY:0100(1–9999)

These two parameters set a global command which allows the weld control to sample data for analysis at controlled intervals.

The sample size is the amount of weld data collected for analysis (number of consecutive welds, per bin). The sample frequency is the total number of welds per bin, where data was collected (the samples are taken from).

For example, by setting the Data Collection Sample Size parameter to 2 and the Data Collection Sample Frequency parameter to 8, the control will collect weld data for 2 consecutive welds (in bin #1), and flag the XWSS to retrieve the data. It will then collect data for 6 more cycles (without flagging XWSS) before starting the process again.

The example table on the next page is for Bin #1 ONLY.

Sample/ Frequency	WCU Process	WIS/WSS Process
1/8	Data flagged for retrieval	Data uploaded
2/8	Data flagged for retrieval	Data uploaded
3/8	Data collected	Data ignored
4/8	Data collected	Data ignored
5/8	Data collected	Data ignored
6/8	Data collected	Data ignored
7/8	Data collected	Data ignored
8/8	Data collected	Data ignored
1/8	Data flagged for retrieval	Data uploaded
2/8	Data flagged for retrieval	Data uploaded
3/8	Data collected	Data ignored
4/8	Data collected	Data ignored
5/8	Data collected	Data ignored
6/8	Data collected	Data ignored
7/8	Data collected	Data ignored
8/8	Data collected	Data ignored

NOTE: *Weld Data Collection is bin dependent. Each bin has its own independent counter and is uploaded to XWSS separately.*

SCR Short Detection

.

The MedWeld 3005 provides two parameters to aid in detecting either shunting current or a shorted SCR.

By setting the SHORT DETECTION setup parameter to ENABLE, the processor continuously monitors the primary voltage across the SCRs when the control is not executing a weld function.

DO NOT disable short detection (by setting this parameter to DISABLE) for normal operating conditions.

Danger!



When disabling short detection, the control will not shunt trip the circuit breaker in case of an SCR short. The control will not detect situations such as a catastrophic SCR failure. This can cause tool damage, and create the potential for serious injury or death.

When the processor detects no voltage drop across the SCRs during four out of seven half-cycles, it examines the primary current to determine whether the drop was due to a shorted SCR:

- Primary current *exceeding* a preset amperage indicates a shorted SCR. The weld processor *immediately* generates a SHORTED SCR fault.
- If the primary current is *less than* a preset amperage, the processor checks the SCR Cycle Limit parameter to determine whether the voltage drop was due to a shorted SCR or shunting current.
- The SCR Cycle Limit parameter sets the maximum number of consecutive cycles where a shorted SCR condition (without current) can occur before the breaker is tripped. The control then generates the appropriate fault (SHORTED SCR or CURRENT SHUNTING fault).

WARNING!



If the control detects a shorted SCR condition with current for four out of seven half-cycles, the control will trip the breaker, regardless of the programmed value of this setup parameter.

- If the control detects no primary current for 3 or more consecutive cycles, it generates the WELDER CURRENT SHUNTING fault. (If the SCR is shorted or current is shunting, primary current will not be detected.) This fault conditions indicates that shunting was detected for more than 3 cycles *but less than* the number of cycles programmed in the Shorted SCR Cycle Limit setup parameter.

NOTE:

These parameters check different conditions. Shorted Cycle Limit checks

for shorted conditions when current is applied. Weld Current Shunting checks for problems when primary current is NOT detected.

Retract Features

• • • • • • • • • •

This section details the retract operation and how certain programmable functions and setup parameters affect the operation:

- Retract Mode
- Initiate from Retract and
- Cylinder Type.

WARNING!



For safety, the MedWeld 3005 ignores any changes to these parameter settings until power is removed from the control. (The control checks the status of these parameters only at power-up.)

Retract Mode Setup Parameter

The Retract Mode setup parameter determines how the control will react to the presence of an active RETRACT PILOT input. (This parameter is described in detail on page 6-10.)

- **UNLATCHED** tells the control to let the output for the Retract valve follow the state of the RETRACT PILOT input. This is for applications which use a toggle or selector switch. (The output will be active while the input is active.)

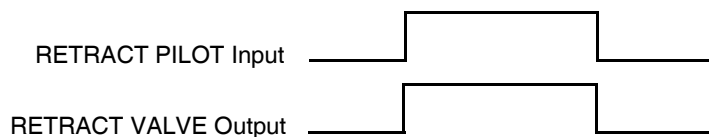

- **LATCHED** tells the control to change the state of the output each time it receives a pulse from the RETRACT PILOT input. (The control expects a brief pulse from the input, such as from a push button.)

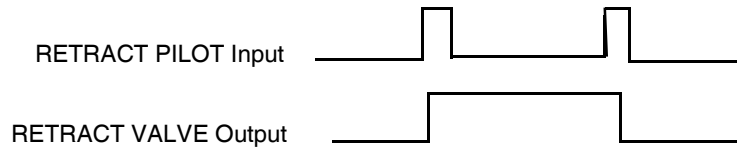

NOTE: *Selecting LATCHED retract may require toggling the state of the RETRACT PILOT input at power-up (to change the state of the RETRACT VALVE output). This will be required if the control powers up in the incorrect retract state, or if the of the RETRACT PILOT input status changes while the control is in a C-Stop condition (the CONTROL STOP input is LOW).*

Cylinder Type

This parameter defines the type of gun cylinder being used in the control application. This parameter enables defining the retract operation, as shown below:

Air-Only Cylinders:

With air-only cylinders, two valves control the weld gun: The Weld valve and the Retract valve.

- The **Retract** valve allows the gun to close to a set gap position. Usually, a spring or a second return valve returns the gun to the full open position.
- The **Weld** valve closes the gun under the welding air pressure.

The air-only cylinders are identified as shown below in the CYLINDER TYPE setup parameter:

- **AIR-NORMAL** tells the control the gun is an air-only cylinder using “normal” retract. (The output is turned OFF to close the gun.)

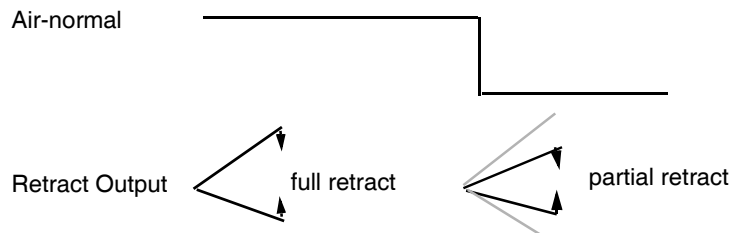

- **AIR-INVERTED** indicates an air-only cylinder, but the output is turned ON to close the gun.

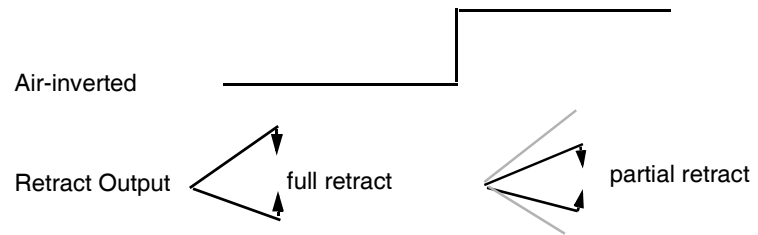

The following sections detail the retract operation under a variety of combinations of parameter settings. (The Retract Mode setup parameter is described on page 6-10.)

Initiation From Retract

The processor also provides a function which you can place in a weld schedule to tell the control to check whether the selected cylinder is out of retract. Function #89 (VERIFY CYLINDER #n IS OUT OF RETRACT) will abort the schedule and generate a RETRACT PILOT fault if the cylinder is NOT out of retract.

NOTE:

Program the RETRACT PILOT fault as an ALERT condition in the setup parameters, so the operator can place the valve in the partial retract position and re-initiate the weld schedule.

If this condition is defined as a FAULT, the control will require a fault reset before it can continue. (An exception is when the Initiation On Fault setup parameter is set to ALLOW, as described on page 6-9.)

If the weld schedule does NOT contain this function, the control will allow you to execute a sequence with the gun in the full retract position.

The MedWeld 3005 provides a number of programmable *setup parameters*. They allow for customizing the control to meet your application requirements.

These parameters “inform” the control about its operating environment. They also define the hardware (such as the type of transformer used and its turns ratio), and describe acceptable limits on the ranged of weld parameters (such as secondary current, power factor and C-factor).

Some parameters define the severity of fault conditions (as either FAULT or ALERT). They tell the control how to respond when it detects a fault condition:

- **FAULT** tells the control to turn OFF the NO FAULT output, or turn ON the FAULT output. This indicates that a fault condition was detected.

Fault conditions normally inhibit initiation of a weld schedule. (Refer to the INITIATION ON FAULT setup parameter on page 6-9.)

- **ALERT** tells the control to activate the ALERT output. An alert condition generally will not inhibit initiating a weld schedule.
- **NONE** tells the control to log that the condition was detected, but neither output is activated. This condition will not inhibit initiation of a weld schedule.

Parameter settings are programmable (with some exceptions). However, the *list* of parameters is fixed. You CANNOT remove a parameter from this list.

You can change the value assigned to a parameter from the DEP-100S Programming Device, XWSS system, MedVIEW, MedVIEW *lite* or MedCommander. (Refer to “Programming the Weld Processor” on page 2-16 for further information on these programming options.)

NOTE: *To protect the operator or equipment, some parameters are NOT programmable. For these, you CANNOT change the setting or value.*

The following section shows each setup parameter as displayed at the programming device, along with all of the possible settings. For example, if a parameter is always defined as a fault condition, (FAULT) will appear. If it can be changed to an alert condition, you will see (FAULT)(ALERT).

If a parameter is a numeric value, this manual lists the default setting of that value. The acceptable range of values will also appear in parentheses.

Parameter Descriptions

.

INVALID SEQUENCE SELECTED: (FAULT)

This fault is generated if the PARITY input (when provided) was not used to provide the odd number of inputs needed to initiate a schedule. It can also indicate that the BINARY SELECT inputs have changed state while the processor is repeating.

WELD INITIATE NOT PRESENT: (FAULT) (ALERT)

If the weld schedule is using the function to TURN ON WELD COMPLETE, the MedWeld 3005 expects the INITIATE WELD input to remain active while executing the weld schedule. If this input is not active when the weld control executes the function TURN ON WELD COMPLETE, the control generates this condition.

If the weld schedule does not contain the TURN ON WELD COMPLETE function, the control does not generate this fault/alert condition.

CONTROL STOP: (FAULT) (ALERT)

This fault is generated if the CONTROL STOP input (normally high) goes low during the execution of a weld schedule, or if the CONTROL STOP input is not active when the control receives a weld initiate.

STEPPER APPROACHING MAX: (FAULT) (ALERT) (NONE)

When a weld schedule is assigned to a linear stepper, this fault indicates that the stepper has begun the final step of the assigned stepper.

END OF STEPPER: (FAULT) (ALERT)

The END OF STEPPER fault indicates that a stepper has completed the last weld in the final step of the assigned stepper.

SUREWELD TREND LIMIT: (FAULT) (ALERT)

If the last weld schedule initiated was assigned to a SureWeld stepper, this condition indicates that a stepper reached a programmed alert point (as defined by the stepper parameters). This indicates that the stepper is applying the maximum current boost allowed to the weld.

HIGH CURRENT LIMIT: (FAULT) (ALERT)**LOW CURRENT LIMIT: (FAULT) (ALERT)**

These faults indicate that the welding conditions during a weld function, exceeded or fell below the range programmed in the setup parameters.

SCR MISFIRE: (FAULT) (ALERT)

This condition occurs if there is conduction on one half-cycle and no conduction on the next half-cycle during a weld function. This condition may result if arcing occurs during the weld functions.

TIPS NOT TOUCHING: (FAULT)**TIPS TOUCHING: (FAULT)**

These two conditions are mutually exclusive. (Both cannot occur within one weld schedule.) Three causes can generate these faults:

- **If the schedule contains the test fire function (#39) and the function FAULT IF TIPS TOUCHING, AND the control detects *more than 10 A.* of primary current during the test fire, the control assumes that the tips were *closed*. It then generates the TIPS TOUCHING fault.**
- **If the schedule contains the test fire function and the function FAULT IF TIPS NOT TOUCHING, AND the control detects *less than 10 A.* of primary current during the test fire, the control assumes that the tips were *open*. It generates the TIPS NOT TOUCHING fault.**
- **If the weld schedule contains the function VERIFY TIPS DOWN EVERY nn CYC nn TIMES, and the control performs the maximum number of test fires without reaching the desired current value (in the Tips Down Verified Current: nnnn setup parameter), it generates a TIPS NOT TOUCHING fault. (Refer to “Dynamic Squeeze Features” on page 5-7.)**

SLOW CYLINDER FAULT: (FAULT) (ALERT)

This fault is generated when the control executes the function SLOW CYLINDER TEST EVERY nn CYC. nn TIMES, and it detects that primary current has never reached the value programmed in the Tips Down Verified setup parameter.

(The control repeats the test fire the number of tries programmed in this function.) Refer to “Dynamic Squeeze Features” on page 5-7.

INITIAL P.F. OUT OF RANGE: (FAULT) (ALERT)

This fault is generated when the test fire function (#39) appears in a weld schedule before the function INITIAL PF LIMIT: HI=nn% LOW=nn%.

If the power factor (indicating secondary resistance) detected during the test fire is not within the range specified in this function, this condition is generated.

POWER FACTOR LIMIT: (FAULT) (ALERT)

This condition is generated when the power factor detected while executing a weld schedule does not fall within the range defined by the High and Low Power Factor Limit setup parameters.

NOTE: *Function #96 permits overriding the setup parameter for power factor limits.*

VOLTAGE COMPENSATION LIMIT: (FAULT) (ALERT)

This fault indicates that the %I firing mode could not fully compensate for a large swing in line voltage. (The processor can provide weld current in a range from 20% to 99%I. However, AVC faults may occur if the programmed range is at or near these limits.)

INSUFFICIENT LINE VOLTAGE: (FAULT) (ALERT)

This fault indicates that the weld initiate was removed or time expired while the control waited for the programmed line voltage (in Function #72 or #73).

EXTENDED WELD: (FAULT) (ALERT)

This fault is generated under one of two conditions, based on which REWELD function appears in the weld schedule:

- **If the schedule contains the function REWELD IF CURRENT LESS THAN 00000 AMPS, this indicates that the control was not able to provide the desired secondary current during the weld, and performed an unsuccessful reweld.**

- **If the schedule contains the function REWELD IF LOW CURRENT LIMIT FAULT, this indicates that the control performed a reweld, and the desired current *was* provided during the reweld.**

ISO CNTR OFF WHEN NEEDED: (FAULT)

The isolation contactor was not pulled in when required by the weld schedule. This parameter is NOT programmable.

This fault is generated when the control detects that the isolation contactor is open when it is trying to execute a weld function. (The contactor must be closed to provide weld current.)

On detecting this condition, the control schedules in No Weld and generates this fault condition. If the control is in No Weld mode, it does not generate a fault.

**CURRENT REGULATION LIMIT: (FAULT) (ALERT)
(NONE)**

The secondary current provided to a weld is monitored each cycle during an ACC weld function, to provide the desired current to a weld. If necessary, the control adjusts the current provided based on the current read during the previous cycle.

This fault occurs if the control hits a firing limit while trying to obtain the desired current, indicating that it could not compensate for the current drop. It can also occur if the amount of current programmed in the weld function causes the control to fire below 20%I.

ISO CNTR ERR-BRKR TRIPPED: (FAULT)

This fault is generated when the MedWeld 3005 signals to open the isolation contactor (to cut off weld current) but the isolation contactor did NOT open. It can also occur if the isolation contactor is pulled in when a weld initiate is not present.

NO ZERO CROSSING SYNC: (FAULT)

This condition is generated when the control is unable to synchronize with the line voltage. This parameter is NOT programmable. This fault is observed when the circuit breaker is turned off or tripped.

LOW BATTERY: (FAULT) (ALERT)

A battery back-up maintains RAM integrity while the control is powered down. This condition is generated when the control detects that the battery's charge is low. To clear this fault, replace the battery within 30 to 60 days.

HIGH C-FACTOR LIMIT: (FAULT) (ALERT)
LOW C-FACTOR LIMIT: (FAULT) (ALERT)

These two conditions indicate that the actual C-Factor read during the weld exceeded or fell below the values programmed in the C-Factor function (C-FACTOR LIMIT: HI=nnn LOW=nnn).

The low limit is helpful to detect cable and connection deterioration. The upper limit can detect secondary bridges and shunting paths. (Refer to “C-Factor” on page 5-1 for more information.)

SYSTEM COOLING: (FAULT)

This fault is generated if the control receives a valid weld initiate and the TRANSFORMER OVER-TEMPERATURE/SYSTEM COOLING input is not active. This fault is also generated if the SCR thermal switch is tripped.

HEAT CYCLE LIMIT: (FAULT) (ALERT)

This fault is generated when the control detects that the number of consecutive weld cycles where conduction occurred exceeded the limit programmed in the Heat Cycle Limit (0=SEAM) setup parameter.

When the limit is exceeded, the weld schedule is finished in No Weld Mode. The control generates a HEAT CYCLE LIMIT fault.

WELD INTERRUPTION: (FAULT) (ALERT)

This fault is generated under three conditions:

- **If the control moves into No Weld Mode while sequencing.**
- **If the control powers down while sequencing.**
- **If the SLC processor and the WTC weld processor lose communication while the control is executing a schedule.**

I/O UPDATE: (FAULT)

This fault may occur in one of these conditions:

- The SLC processor entered Program Mode while the control was executing a weld sequence.
- The WTC weld processor and the SLC processor lose communications for more than the time specified in the I/O Update Timeout (mSEC): nnn setup parameter. The fault may be set at any time, including when the control is initiating a schedule. If this occurs, the schedule is aborted.

When the control is idled and not initiated, the timeout interval is fixed at 10 sec.

- The SLC processor stopped scanning.
- When the weld processor and PLC processor cannot communicate over the rack backplane. If this timeout occurs, major system bus faults are suspect.
- If the SLC processor moves out of Run Mode while the control is executing a schedule.

RIO COMM ERROR/NOT IN RUN MODE: (FAULT)

This fault occurs

- If the host PLC connected to the RIO link moves out of Run Mode, or
- The link encounters a fatal communication error while the control is executing a schedule.

In either case, this fault is flagged regardless of the state of the I/O VALID input.

WELD PROCEED: (FAULT) (ALERT)

This fault is generated if the WELD PROCEED input does not become active within the number of cycles specified in the function WAIT nnn CY. FOR WELD PROCEED.

PRESSURE SWITCH: (FAULT) (ALERT)

This fault is generated if the PRESSURE SWITCH input does not become active within the number of cycles specified in Function #68 (WAIT nnn CY. FOR PRESSURE SWITCH) or if the weld initiate is removed while the control is waiting in Function #69 (WAIT FOR PRESSURE SWITCH).

RETRACT PILOT: (FAULT) (ALERT)

The function VERIFY CYLINDER #n IS OUT OF RETRACT tells the control to confirm that the selected cylinder is out of retract. If the cylinder is NOT out of retract, the control will abort the schedule and generate this fault.

WELDER CURRENT SHUNTING: (FAULT) (ALERT)

This fault is generated when the control detects that a shorted SCR condition occurred for 3 or more consecutive cycles, but less than the programmed value, in the Shorted SCR Cycle Limit setup parameter.

ISO CONTACTOR NOT ENABLED: (FAULT)

This fault is generated if the isolation contactor is de-activated (opens) while the control is sequencing.

CONTROL IN NO WELD: (FAULT) (ALERT)

This fault occurs if the control moves from Weld Mode into No Weld Mode while sequencing. This fault is also generated if the control receives a weld initiate while in No Weld Mode.

INITIATION ON POWER-UP (FAULT)

This fault is set if initiates are present on power-up.

PRESSURE NOT ACHIEVED: (FAULT)

Program #T93300-19 and above supports analog I/O through an analog card in the SLC rack. Three setup parameters implement this support.

This fault occurs when the proportional valve pressure (programmed by functions #08, #13 or #14), was not achieved within the number of cycles programmed in Function #09 (WAIT nn CY FOR PRESSURE ACHIEVED).

If the sequence contains more than one valve pressure setting, the processor will only monitor the last pressure function contained in the sequence, if you do not use the Cascade Firing support.

This parameter is permanently set to the FAULT condition. You CANNOT program it.

SECONDARY CURRENT COIL/BOARD: (FAULT)

Program T93300-00-20 and above support secondary current monitoring through a secondary current coil. This fault will be generated under the following conditions:

- **If an error occurred while attempting to initialize or configure the SCIB due to a malfunction on the SCIB board or an improper connection to the weld timer.**
- **If an error occurred during the secondary current calibration process due to an improper connection to the secondary current coil.**
- **If an error occurred during the secondary calibration process due to a loss of primary power (no zero-crossing synchronization).**
- **If an error occurred during the secondary calibration process due to a missing current range jumper on the SCIB board.**

CURRENT MONITOR MODE: (PRIMARY)
(SECONDARY)

Program T93300-00-20 and above support secondary current monitoring through a secondary current coil. Select either *primary* or *secondary* current monitoring. If selecting secondary current monitoring, a Secondary Current Interface Board (SCIB) and secondary current-sensing coil must be attached.

TRANSFORMER TYPE: (AC WOUND)
(DC WOUND)
(AC STACKED)
(DC STACKED)

This parameter has four selections: AC WOUND, AC STACKED, DC WOUND or DC STACKED.

When selecting *AC STACKED* or *DC STACKED*, the first half-cycle of each pulse is fired completely, as required by the weld schedule.

By selecting *AC WOUND* or *DC WOUND*, the control uses delayed firing to prevent damage caused by firing at too great a phase angle on the first cycle of a weld or impulse.

AC regulates on the current that is actually read. DC uses a special algorithm to approximate the current.

CURRENT LIMIT MODE: (AVERAGE) (PEAK)

This parameter specifies which method the control will use during current limit processing.

- **If this parameter is set to *PEAK*, the fault is generated if the current limit is exceeded during any one cycle.**
- **If set to *AVERAGE*, the control adds the current read during each cycle and divides by the number of cycles to determine average current. The fault is generated only if the average current exceeds the limit.**

INHIBIT INITIATION ON FAULT
ALLOW INITIATION ON FAULT

This parameter tells the control how to react if it receives a weld initiate when a fault condition is present.

- ***INHIBIT* tells the control to ignore the initiate and generate this fault.**
- ***ALLOW* tells the control to ignore the fault condition and initiate the schedule.**

SHORT DETECTION: (ENABLED) (DISABLED)

This parameter can override the Shorted SCR Cycle Limit and Welder Current Shunting setup parameters.

Setting to **DISABLE** means that NO shorted SCR conditions of any kind will be detected. No faults will be generated.

ENABLE tells the control to check for shorted SCRs. Refer to the discussion of this feature in “SCR Short Detection” on page 5-11.

Danger!



Use this parameter for test purposes only! Disabling the short detection features can cause catastrophic failure and dangerous operating conditions. ALWAYS set this parameter to ENABLED under normal operating conditions.

RETRACT MODE: (LATCHED)
(UNLATCHED)

This parameter tells the control how to react when it receives the RETRACT input:

- **UNLATCHED** tells the control to let the RETRACT output follow the state of the RETRACT input. (When the input is on, the output is ON; when the input is off, the output is OFF.)
- **LATCHED** tells the control to change the state of the RETRACT output when the input is briefly turned on and then off (pulsed).

WARNING!



For safety, the MedWeld 3005 ignores any changes made to this parameter until you reset the control (by cycling power).

CYLINDER: (AIR-NORMAL)
(AIR-INVERTED)

This setup parameter defines what type of weld gun cylinder is being used.

- **AIR-NORMAL**—Select this type of cylinder when the machine uses an air-only cylinder, AND the RETRACT output is turned OFF to close the gun.

- **AIR-INVERTED**—Select this type of gun cylinder when the machine uses an air-only cylinder, AND the RETRACT output is turned ON to close the gun.

WARNING!

For safety, the MedWeld 3005 ignores any changes made to this parameter, until you reset the control (by cycling power).

HIGH POWER FACTOR LIMIT (%): 99 (10–99)

LOW POWER FACTOR LIMIT (%): 10 (10–99)

These two parameters tell the weld control the range of acceptable values for power factor. If the power factor exceeds or falls below these limits, a HIGH or LOW POWER FACTOR LIMIT fault is generated.

The HIGH POWER FACTOR LIMIT fault can help warn of a deteriorating secondary. A LOW POWER FACTOR LIMIT fault can indicate a control malfunction, or an increase in inductive resistance.

NOTE:

Function #96 permits overriding the High and Low Power Factor Limit setup parameters.

TIPS DOWN TEST FIRE %%l: 20 (20–99)

The welding schedule uses this value of heat when the control executes the functions VERIFY TIPS DOWN EVERY nn CYC. nn TIMES or SLOW CYLINDER TEST EVERY nn CYC. nn TIMES.

Program the lowest value possible to reduce the open secondary voltage, while keeping this value high enough so that the current detected when tips are down exceeds the TIPS DOWN VERIFIED CURRENT setup parameter.

For more information, refer to the description of this parameter in “Dynamic Squeeze Features” on page 5-7.

VALVE 1 INITIAL PRESSURE (PSI): (nn)

VALVE 2 INITIAL PRESSURE (PSI): (nn)

This parameter lets you set a base pressure for each pressure valve. This sets the initial pressure to be supplied to the valve at power-up and at the end of a weld sequence.

nn sets the pressure in the range 0 – 99 PSI. The default setting is **50 PSI**.

HEAT CYCLE LIMIT (0=SEAM): 60 (0–99)

This parameter defines the maximum number of consecutive cycles of heat conduction. (After nine consecutive cycles without conduction, the heat cycle counter is reset to zero.)

For seam welding applications, disable this function by setting the cycle limit to zero.

ISOLATION CONTACTOR DELAY: 05 SEC(0–99)

This parameter tells the control how long to hold the isolation contactor pulled in after the function TURN OFF ISOLATION CONTACTOR executes. This is designed to prevent wear on the isolation contactor caused by dropping in and out between welds.

When the ISOLATION CONTACTOR SAVER input is available and set LOW, it disables this delay timer.

NOTE: *Function #77 overrides this setup parameter.*

HIGH CURRENT LIMIT WINDOW: 20 % (0–99)

LOW CURRENT LIMIT WINDOW: 20 % (0–99)

These two parameters define a global current range for every weld schedule.

The MedWeld 3005 calculates the high current window as a percentage boost over the current expected. The low current window is a percentage decrease from the expected current. (The expected current is the base current—programmed in the weld function—plus the current that the stepper is providing.)

For ACC, the base is the actual secondary current value programmed. %I is derived by determining the maximum current deliverable, and the percentage of that current programmed in the weld schedule.

SHORTED SCR CYCLE LIMIT: 60 (3–99)

This parameter sets the maximum number of consecutive cycles where a shorted SCR condition (without current) can occur before the breaker is tripped.

WARNING!



If the control detects a shorted SCR condition with current for four out of seven half-cycles, the control will trip the breaker regardless of the programmed value of this setup parameter. Refer to the description of these features in “SCR Short Detection” on page 5-11.

DATA COLLECTION SAMPLE SIZE: n 5 (1–99)
 DATA COLLECTION SAMPLE
 FREQUENCY: nnnn (1–9999)

These two parameters set a global command which allows the weld control to sample data for analysis at controlled intervals.

The sample size is the amount of weld data collected for analysis (number of consecutive welds, per bin). The sample frequency is the total number of welds (per bin) where data is collected (the samples are taken from). See “SPC Indexing Capabilities” on page 5-9 for more information.

TIPS DOWN VERIFIED CURRENT: nnnn (0–9999)

This is the value of current that is used as the threshold when the control executes the functions VERIFY TIPS DOWN nn CY. nn TIMES or SLOW CYLINDER TEST EVERY nn CYC. nn TIMES.

Determine this value by experimenting to distinguish open and closed secondary currents for various heat settings.

For more information, refer to the description of this parameter in “Dynamic Squeeze Features” on page 5-7.

TRANSFORMER TURNS RATIO: nnn:1 (1–256:1)

This parameter tells the control the turns ratio of the welding transformer used. This lets the control determine secondary current during a weld. (Secondary current equals the primary current multiplied by the turns ratio.)

Cautions:

The control uses this value to determine the secondary current provided. Be certain to correctly program this parameter for the operating environment BEFORE attempting to use the weld functions using Automatic Current Compensation (ACC). (**Note:** The TURNS RATIO function allows overriding this parameter setting.)



When programming the control for ACC Firing (Functions #30–34), if you change the turns ratio, the control will require the first two cycles of the next weld to adjust the current.

NOMINAL LINE VOLTAGE: nnn (100–650)

The control use this parameter to establish a reference point for determining the compensation required for line voltage fluctuations when welding in the %I firing mode.

NOMINAL C-FACTOR: nnn (0–999)

The C-factor represents the value of current obtained or expected for each percentage of maximum current deliverable. The programming device displays the actual C-Factor detected by the MedWeld 3005. You can program the acceptable range of C-factor in a weld schedule.

To determine the nominal C-Factor, first perform a series of welds. Record the actual C-factor displayed at the programming device. Calculate the average, and enter that as the nominal C-factor value.

I/O UPDATE TIMEOUT (MSEC): nnnn (0–9999)

This setup parameter programs the maximum length of time in which the WTC weld processor and SLC processor can lose communications while initiating without generating an I/O TIMEOUT fault.

The following parameter supports operation of the Secondary Current Interface Board (SCIB):

SEC. CURR COIL MULTIPLIER (X1000): nnnn (0-9999)

Program T93300-00-20 and above support secondary current monitoring through a secondary current coil. Use this setup parameter when monitoring secondary current as an adjustment to accommodate for secondary current sensing coils of different sensitivities. Setting this parameter to 1000 will result in accurate secondary current readings for coils of 0.477 μ Hy mutual inductance (150 mV/kA @ 50 Hz, or 180 mV/kA @ 60 Hz). Setting this parameter *above* 1,000 will increase the reading. Setting *below* 1,000 will decrease the reading.

Quick Reference to Setup Parameters

• • • • • • • • • •

The following list shows the default value for each parameter, as programmed at the factory:

INVALID SEQUENCE SELECTED	(FAULT)
WELD INITIATE NOT PRESENT	(ALERT)
CONTROL STOP	(FAULT)
STEPPER APPROACHING MAX	(ALERT)
END OF STEPPER	(FAULT)
SUREWELD TREND LIMIT	(ALERT)
HIGH CURRENT LIMIT FAULT	(FAULT)
LOW CURRENT LIMIT FAULT	(FAULT)
SCR MISFIRE	(ALERT)
TIPS NOT TOUCHING	(FAULT)
TIPS TOUCHING	(FAULT)
SLOW CYLINDER FAULT	(ALERT)
INITIAL P.F. OUT OF RANGE	(ALERT)
POWER FACTOR LIMIT	(ALERT)
VOLTAGE COMPENSATION LIMIT	(ALERT)
INSUFFICIENT LINE VOLTAGE	(ALERT)
EXTENDED WELD	(FAULT)
ISO CNTR OFF WHEN NEEDED	(FAULT)
CURRENT COMPENSATION LIMIT	(ALERT)
ISO CNTR ERR-BRKR TRIPPED	(FAULT)
NO ZERO CROSSING SYNC	(FAULT)
LOW BATTERY	(ALERT)
HIGH C-FACTOR LIMIT	(ALERT)
LOW C-FACTOR LIMIT	(ALERT)
SYSTEM COOLING	(FAULT)
HEAT CYCLE LIMIT	(FAULT)
WELD INTERRUPTION	(FAULT)
I/O UPDATE	(FAULT)
RIO COMM ERROR/NOT IN RUN MODE	(FAULT)
WELD PROCEED	(FAULT)
PRESSURE SWITCH	(FAULT)
RETRACT PILOT	(FAULT)
WELDER CURRENT SHUNTING	(ALERT)
ISO CONTACTOR NOT ENABLED	(FAULT)
CONTROL IN NO WELD:	(ALERT)
INITIATION ON POWER-UP	(FAULT)
PRESSURE NOT ACHIEVED	(FAULT)
SECONDARY CURRENT COIL/BOARD	(FAULT)
CURRENT MONITOR MODE	(PRIMARY)
TRANSFORMER	(AC WOUND)
CURRENT LIMIT MODE	(AVERAGE)
INITIATION ON FAULT	(INHIBIT)

SHORT DETECTION	(ENABLED)
RETRACT MODE	(LATCHED)
CYL	(AIR-NORMAL)
HIGH POWER FACTOR LIMIT	(99%)
LOW POWER FACTOR LIMIT	(10%)
TIPS DOWN TEST FIRE %I	(20%)
VALVE 1 INITIAL PRESSURE	(50 PSI)
VALVE 2 INITIAL PRESSURE	(50 PSI)
HEAT CYCLE LIMIT (0=SEAM)	(60 CYCLES)
ISOLATION CONTACTOR DELAY	(5 SEC)
HIGH CURRENT LIMIT WINDOW	(20%)
LOW CURRENT LIMIT WINDOW	(20%)
SHORTED SCR CYCLE LIMIT	(60 CYCLES)
DATA COLLECTION SAMPLE SIZE	(5)
DATA COLLECTION SAMPLE FREQUENCY	(100)
TIPS DOWN VERIFIED CURRENT	(10 AMPS)
TRANSFORMER TURNS RATIO	(100:1)
NOMINAL LINE VOLTAGE	(468 VOLTS)
NOMINAL C FACTOR	(999)
I/O UPDATE TIMEOUT	(250 mSEC)
SEC. CURR COIL FACTOR (X1000)	(1000)

The MedWeld 3005 provides *steppers*, to help compensate for changes in the welding environment. These stepper settings are programmable, to control how the weld processor will compensate for these variations.

What is a Stepper?

.

The MedWeld 3005 provides two distinct types of steppers:

- A *linear* stepper (which adds heat according to a stepper profile that you program) and
- The *SureWeld* stepper. This monitors expulsion and maintains the weld current at a point just below expulsion, based on a list of parameters you program.

You program steppers using the WTC programming device. Tell the weld processor which type of stepper you want to control the weld schedule, by using the stepper assignment functions (#82 or #83). These assign both a stepper number and the type of stepper (linear or SureWeld) to the weld schedule.

You can program up to 99 linear steppers and 99 SureWeld steppers. The following sections describe each stepper type, along with directions on how to program the steppers.

You can assign a stepper to a group. This capability allows for incrementing the stepper when the control executes any weld schedule assigned to that group. You can also advance or reset a group of steppers.

Linear Steppers

• • • • • • • • • •

The conventional linear stepper tracks the number of welds completed. It increases the heat provided to the weld at several programmed set points. This serves to compensate for drifts in the welding process.

The stepper profile consists of a number of linear steps, and a parameter to allow stepper grouping. Each linear step applies additional weld current over a number of welds.

Because the stepper is linear, if a step is programmed to add 3% current over 100 welds, it will actually add 1% after 33 welds, and another 1% after 66 welds. (Heat is added in minimum increments of 1%, based on the function selected.) By the 100th weld, the stepper is adding the full 3% current boost to the amount of current programmed in the weld function.

At the end of a weld schedule, the control will verify the stepper that was activated to see which group it belongs to. The control then bumps up the weld count on all steppers that are associated to the group. (Use the DEP-100S or other programming device to assign steppers to a group.)

For example, if one gun (tips) was used to several different schedules using different steppers, grouping allows you to automatically increment the stepper for every schedule in the group every time the gun is fired.

When the control completes the last weld in the last step, the electrode tips must be dressed and the stepper reset.

To use the linear stepper, you must include Function #82 as the *first* function in the weld schedule.

NOTE: *The stepper is not active during every weld function: it is incremented only when you execute the following functions that provide weld current:*

```

20  WELD 00 CY 00 %I
25  WELD 00 CY 00.0%I
26  WELD 00 HALF CYCLES 00.0%I
30  WELD 00 CY 00000 AMPS
36  WELD 00 HALF CYCLES 00000 AMPS
40  SLOPE 00 CY 00% TO 00% I
45  SLOPE 00 CY 00000 AMPS TO 00000 AMPS

```

Default Linear Stepper Profile

As shipped from the factory, the linear steppers use this profile by default:

```

START OF STEPPER
STEP #1 03 %i 0700 AMPS IN 0060 WELDS
STEP #2 03 %i 0700 AMPS IN 0180 WELDS
STEP #3 03 %i 0700 AMPS IN 0300 WELDS
STEP #4 03 %i 0700 AMPS IN 0600 WELDS
STEP #5 03 %i 0700 AMPS IN 0800 WELDS
STEP #6 00 %i 0700 AMPS IN 0000 WELDS
STEP #7 00 %i 0700 AMPS IN 0000 WELDS
STEP #8 00 %i 0700 AMPS IN 0000 WELDS
STEP #9 00 %i 0700 AMPS IN 0000 WELDS
STEP #10 00 %i 0700 AMPS IN 0000 WELDS
STEPPER GROUP #00
END OF STEPPER
    
```

Use one of the programming methods (DEP-100S, XWSS, MedVIEW, MedVIEW *lite* or MedCommander) to change the stepper profile to the values required by your application.

Display at the DEP-100S

When you select the linear stepper status display from the DEP-100S, use this display to view the stepper status:

```

POWER ON                                     COMM ON
.....
LINEAR STEPPER STATUS:
  Boost: +00%                               Total Welds=00000
  Step #01                                  Step Count=0000
  stpr #01                                  advance      wcu#00*
.....
      F1                F2                F3                F4
    
```

This display shows the amount of energy being added to each weld function (**Boost**), the current step and the selected stepper (**stpr**), as well as the total weld count and the step count (the number of welds completed during the current step).

From the stepper status display,

- Press **F1** to see a different stepper
- Press **F3** to advance the stepper
- Press **F4** to see the stepper settings for a different weld processor (**wcu#**)

- Press **F5** to see additional stepper options. The asterisk (*) indicates that additional displays or information are available. When you press **F5**, you see the stepper reset option at **F3** ; or
- Press **F5** a second time, and you'll see a display showing the status of every linear stepper:

```

POWER ON                                     COMM ON
.....
          Stpr  1-8      . . . . .
STEPPER  Stpr  9-16     . . . . .
STATUS   Stpr 17-24    . . . . . *
.....
          F1           F2           F3           F4
    
```

- Press **F5** a third time to return to the initial stepper display.

SureWeld Steppers

.

The SureWeld stepper accurately measures the **power factor** during each cycle of weld. Power factor indicates changes in the electrical resistance of the weld. This, in turn, indicates the magnitude of weld expulsion.

The SureWeld stepper compensates for tip wear by identifying the current level where expulsion occurs, then backing off the current to a point just below the level of expulsion. The SureWeld stepper automatically adjusts the current as required.

To assign a SureWeld stepper to a weld schedule, you **MUST** include Function #83 as the first function in the weld schedule.

NOTE: *The stepper is NOT active during every weld function. It is incremented only when executing the following functions that provide weld current:*

- 20 WELD 00 CY 00 %I
- 25 WELD 00 CY 00.0%I
- 26 WELD 00 HALF CYCLES 00.0%I
- 30 WELD 00 CY 00000 AMPS
- 36 WELD 00 HALF CYCLES 00000 AMPS
- 40 SLOPE 00 CY 00% TO 00% I
- 45 SLOPE 00 CY 00000AMPS TO 00000AMPS

SureWeld Parameters

These parameters control the SureWeld steppers:

INC %/I ON 99 WELDS W/O EXPULSION

This parameter programs the “no-expulsion” counter. The control keeps track of the number of welds where expulsion did NOT occur since the stepper last changed the current provided. When the counter reaches the programmed limit, the stepper increases the heat by 1%.

DEC %/I ON 9 WELDS WITH EXPULSION

This counter tracks the number of welds that had expulsion. When this counter reaches the programmed limit, the control decreases the heat by 1%.

BLANKING CYCLES: (01)

At the start of a weld, the power factor drops briefly, due to part fit-up and breaking through surface coating. This parameter tells the control how many cycles at the start of a weld to ignore to prevent misinterpreting these events as expulsion.

A good starting value for this parameter is 1/3 to 1/2 the number of programmed weld cycles.

1-CYCLE EXPULSION DETECTION LEVEL: (00.75%)

This is a drop in power factor that exceeds this programmable set point assumed to be due to expulsion. This value is programmable in increments of 0.01%.

A good method to determine this value is to determine the power factor drop for welds where expulsion did not occur. Then compare it to the power factor seen when welds with expulsion occur.

If this parameter is set too low, the control may misinterpret normal cycle-by-cycle variations. If set too high, expulsion may not be detected.

STEPPER GROUP: (00)

Use this parameter to group SureWeld steppers together. Steppers will be programmed into weld schedules and be associated with a group of steppers.

At the completion of a weld schedule, the control will verify the stepper that was activated to see which group it belongs to. The control then increments the weld count on all steppers that are associated with the group.

POSITIVE TREND LIMIT: (99)

NEGATIVE TREND LIMIT: (99)

These two parameters serve to prevent runaway stepper conditions. These can arise from problems such as improper electrode cooling, incorrect base heat, or arcing secondary current-carrying cables causing problems with the monitoring of power factor drop (PFD).

These parameters limit how much (in either direction) the stepper can modify the current provided to a weld. Starting from zero, the control increments the appropriate trend (positive or negative) every time it adds or subtracts current. When these limits are exceeded, the control generates the SureWeld Stepper Trend condition, as programmed in the setup parameters.

MAXIMUM (-) ADD'L %I (−10)

This parameter sets the limit on how far to decrement the total %I when using the %I firing mode.

MAXIMUM (-) ADD'L CURRENT: (−00000 AMPS)

This parameter sets the limit on how far to decrement the total heat supplied during a weld function when the SCR firing mode is ACC. Total heat is the base I (in A.) defined in the last weld function in the schedule minus the I (in A.) added by the stepper.

MAXIMUM %I: (99%)

This parameter sets the maximum amount of *total heat* to supply during a weld function when the SCR firing mode is %I.

Total heat is the base heat defined in the last weld function in the schedule **PLUS** the heat added by the stepper.

MAXIMUM CURRENT: (99999 AMPS)

When the control is using the ACC firing mode, this parameter defines the *total current* (in secondary A.) to supply during a weld function.

Total current is the base current (in A.) defined in the last weld function in the schedule, **PLUS** the current (in A.) added by the stepper.

NOTE: *If the control detects that the total heat or current reached or exceeded the maximum defined above, it generates the END OF STEPPER condition.*

END OF STEPPER :

This parameter sets the maximum weld count for a SureWeld stepper. When the stepper has completed the number of welds specified by the parameter, the control generates an END OF STEPPER fault. This fault is reset by the STEPPER RESET input.

ALERT POINT%I: (99%)

This parameter defines the point where the SCR alerts you when the stepper is approaching maximum heat, if the SCR firing mode is AVC.

ALERT POINT (CURRENT): (99999)

This parameter defines the point where the SCR alerts you when the stepper is approaching the maximum current (while the SCR firing mode is ACC).

NOTE: *When the control detects that the heat (or secondary current) has reached the alert point programmed, it generates the STEPPER APPROACHING MAX. condition.*

STEPPER APPROACHING MAX.: (99999)

When the weld count reaches this limit, the MedWeld 3005 generates the STEPPER APPROACHING MAX. condition, to indicate that the electrodes require maintenance.

Display at the DEP-100S

When selecting the SureWeld stepper status display from the DEP-100S, use this display to check the status of the SureWeld steppers:

```

POWER ON                                COMM ON
.....
SURE STEPPER STATUS: Max 1 Cy Drop 00.00
  Boost: +00%                            Total Welds=00000
UT=00  DT=00                            No Exp=00  Exp=00
Stpr #01          on          reset  wcu#00*
.....
      F1          F2          F3          F4
    
```

This display shows the status of the values programmed for the SureWeld stepper. These are the amount of boost being added to the weld function, the largest 1-cycle drop detected, the total weld count, the counter of expulsion and no-expulsion welds (**Exp** and **No Exp**), and the two trend counters (**UT** and **DT**).

From this display:

- Press **F1** to see a different stepper (Stpr #)
- Press **F3** to reset the stepper

- Press **F4** to see the stepper settings for a different weld processor (**wcu#**)
- Press **F5** to see additional stepper options. The asterisk (*) indicates that additional displays or information are available. Pressing **F5** displays a screen showing the status of every SureWeld stepper:

POWER ON		COMM ON	
.....			
	Stpr	1-8
STEPPER	Stpr	9-16
STATUS	Stpr	17-24 *
.....			
F1	F2	F3	F4

- Press **F5** a second time to return to the initial stepper display.

For more information on the DEP-100S, refer to the manual provided with this programming device.

Fault Conditions

8

The fault conditions generated by the weld processor may not always identify the source of the problem. However, they do provide a starting point to begin searching.

Certain operating conditions are defined as Faults, Alerts, MAJOR, MINOR or NONE conditions in the setup parameters. However, the control's response to the conditions is standard:

When the control detects a fault condition you defined as MAJOR, it may inhibit welding or inhibit initiation of a new schedule until the fault condition is cleared. Alert or MINOR fault conditions serve more as a warning of a potential problem, or that maintenance may be required. If set to NONE, the control logs the fact that the condition occurred, but takes no action.

The following table lists each fault described in this chapter in alphabetical order, with the page where the description appears:

<u>Fault</u>	<u>Page</u>
CONTROL IN NO WELD	8-12
CONTROL STOP	8-3
END OF STEPPER	8-3
HEAT CYCLE LIMIT	8-10
HIGH C-FACTOR	8-9
HIGH CURRENT LIMIT	8-4
I/O SYSTEM TIMEOUT	8-10
I/O UPDATE TIMEOUT	8-10
INITIAL POWER FACTOR OUT OF RANGE	8-6
INSUFFICIENT LINE VOLTAGE	8-7
INVALID SEQUENCE SELECTED	8-2
ISO CONTACTOR OFF WHEN NEEDED	8-8
ISOLATION CONTACTOR NOT ENABLED	8-11
LOW BATTERY	8-9
LOW C-FACTOR	8-9
LOW CURRENT LIMIT	8-4
NO ZERO CROSSING SYNC	8-9
POWER FACTOR LIMIT	8-6
RETRACT PILOT ERROR	8-11
REWELDED	8-6

Fault	Page
RETRACT PILOT ERROR	6-7
SCR MISFIRE	8-5
SLC NOT IN RUN MODE.....	8-11
SLOW CYLINDER	8-5
STEPPER APPROACHING MAX	8-3
SURE WELD TREND LIMIT	8-3
SYSTEM COOLING.....	8-10
TIPS TOUCHING/TIPS NOT TOUCHING	8-5
VOLTAGE COMPENSATION	8-7
WELD CURRENT SHUNTING	8-12
WELD INITIATE NOT PRESENT.....	8-2
WELD INTERRUPT	8-10
WELD PROCEED	8-11

Message	Explanation	Possible Cause	Remedy
Invalid Sequence Selected (See p. 6-2)	The combination of BINARY SELECT inputs was invalid.	The weld initiate was on but no BINARY SELECT inputs were active.	Turn on the BINARY SELECT input(s) required.
		The PARITY input failed to provide an odd number of inputs.	Check the number of BINARY SELECT inputs used to select the schedule number. If this is an even number, activate the PARITY input.
		Incorrect or loose wiring at the input module.	Check the wiring diagram for proper I/O designations. Verify that all wiring connections are secure.
		Bad connectors, improper seating or faulty SLC processor, input module or weld processor module.	Remove power, re-seat modules and replace as necessary.
Weld Initiate Not Present (See p. 6-2)	The WELD INITIATE input was not active when checked by the control in Function #50.	Weld schedule contains Function #50, but the function is not required by the application.	Remove Function #50 from the weld schedule.
		The robot or PLC ladder logic is not holding the INITIATE input high the amount of time required by the application.	Repair robot or ladder logic program.

Message	Explanation	Possible Cause	Remedy
Control Stop (See p. 6-2)	The control detected that the CONTROL STOP input (normally HIGH) dropped out.	The CONTROL STOP input from the robot or PLC program was not active when the control tried to initiate a weld.	Check/repair ladder logic. Note if the RIO Control Stop is both DIO and Serial I/O.
		The external or internal wiring (feeding CS1 and CS2) or the input module is open, causing a loss of input voltage to the input.	Check the wiring to verify that 24VDC or 120 VAC is being provided to the CONTROL STOP input.
		The operator or ladder logic removed the CONTROL STOP input.	Check and correct the cause.
Stepper Approaching Maximum (See p. 6-2)	The linear stepper assigned to the schedule initiated has started the first weld in the last step.		The electrodes will soon need maintenance. Dress or replace the electrodes to avoid the END OF STEPPER fault condition.
	The stepper profile is programmed incorrectly.		Check the stepper profile.
End of Stepper (See p. 6-3)	A linear stepper in the group # assigned to the schedule initiated completed the last step in the profile.		Dress or replace the electrode tips. Reset the stepper.
Sure Weld Trend Limit (See p. 6-3)	The stepper reached a programmed alert point, indicating that maximum current is being applied to the weld.	The stepper reached the end of its profile.	Dress or replace the electrode tips and reset the stepper.
		The Alert Point Stepper parameter is programmed too low.	Re-program the Alert Point Stepper parameter.
		An unusual condition in the secondary is causing the control to add excessive current. This is causing the control to reach the maximum current boost too quickly.	Check for dirty material, bad kickless cables or shunts, tip alignment, loose connections, air pressure or water pressure/flow problems.

Message	Explanation	Possible Cause	Remedy
High Current Limit (See p. 6-3)	The control detected that the current fired during the weld schedule exceeded the high current limit. (This could be the limit in the setup parameters OR set by Function #76 in the weld schedule.)	The limit is set too low.	Re-program high current limit (Function #76)
		Welder impedance is lower than it was when the current limit was set. The welder may be drawing more current than the originally-calculated maximum.	Check for improper installation of either a kickless cable or shunt cable.
		Pressure being maintained to the tips changed during the weld, so less pressure to the welding spot was provided. The weld processor will compensate, and possibly generate a HIGH CURRENT LIMIT fault.	With a pressure gauge, verify that constant pressure is being maintained. Check for things affecting pressure (such as regulators).
		Incorrect measurement of the primary current. (Since both the weld processor and the firing card are involved in current measurement, certain failures on one of these cards may cause this fault to occur.)	Check for loose wiring at the J3 connector on the firing card.
			Secure the cable that runs between the firing card and the processor. Check for bad connector. Replace as necessary.
Expulsion caused reduction in the weld resistance. (This may cause the current to exceed the calculated maximum.)	Adjust the schedule to reduce expulsion while maintaining sufficient current to provide a good weld.		
Low Current Limit (See p. 6-3)	The current fired fell below the limit programmed, either in the setup parameters or Function #76 in a schedule. OR, the actual energy provided to the weld (KVAT) did not fall within the range specified in Function #19.	Limit is set too high.	Reprogram the limit in Function #76.
		Unusual condition in the secondary.	Check the secondary. Look for dirty material, bad kickless cables or shunts, tip alignment, loose connections or reduced weld force due to hoses binding in the weld gun tooling, faulty or sticking solenoid valves or slow-moving cylinders.
		Incorrect measurement of the primary current. (Since both the weld processor and the firing card are involved in current measurement, certain failures on one of these cards may cause this fault to occur.)	Check for loose wiring at the J3 connector on the firing card.
Secure the cable that runs between the firing card and the processor. Check for bad connector. Replace as necessary.			

Message	Explanation	Possible Cause	Remedy
SCR Misfire (See p. 6-3)	The processor detected conduction on one half-cycle without conduction on the next half-cycle	Faulty wiring. (For example, if the gate and cathode wires are swapped.)	Check all wiring connections. Verify that they are secure and correct.
		Insufficient squeeze time in the weld schedule. (Metal is expelled at the electrode/ material interface.)	Program additional squeeze time in the selected schedule.
		Poor part fit-up or insufficient pressure. (Metal is being expelled at the faying surface.)	Try upsloping or inserting a preheat function (at a low % current) to try to form part fit-ups. Verify sufficient OFF time before the weld function in the weld schedule (typically 20 CY). Also try increasing weld pressure.
		Isolation contactor is dropping out early or coming in late.	Correct isolation contactor program or relay logic circuit.
		Faulty firing card.	Replace firing card.
Tips Not Touching or Tips Touching (See p. 6-3)	The electrode tips were detected as not being closed (or not being open) when expected.	Tips closing (or opening) too slowly, due to dirty or poorly lubricated cylinder or stuck tips.	Check for sticking gun cylinder. Remedy as required.
		Incorrect schedule timing.	Check robot or PLC ladder logic schedule timing.
		Improper threshold programming.	Adjust threshold in setup parameters or functions.
		Faulty cylinder.	Replace or repair cylinder.
Slow Cylinder (See p. 6-4)	The cylinder exceeded the time allowed for closing.	Cylinder closing too slowly due to being dirty or poorly lubricated.	Check for sticking gun cylinder. Remedy as required.
		Faulty cylinder.	Replace or repair cylinder.

Message	Explanation	Possible Cause	Remedy
Extended Weld (See p. 6-4)	The control had to restart the weld schedule due to insufficient secondary current during a weld.	Low current limit is set too high.	Re-program the Low Current Limit setup parameter.
		Unusual condition in the secondary.	Check for improper part fit-up, dirty material, worn electrodes, bad kickless cables or shunts, or loose connections in the secondary circuit.
		Incorrect measurement of the primary current. (Both the weld processor and the firing card are involved in current measurement. A failure on one of these cards may cause this fault to occur.)	Check for loose wiring at the J3 connector on the firing card. Secure the cable that runs between the firing card and the processor. Check for bad connector. Replace as necessary.
Initial Power Factor Out of Range (See p. 6-4)	The control executed a power factor test fire and the PF values were not within range. Also check the schedule timing and part fitup. Verify that the correct valve is programmed in the weld schedule.	The inductance of the welding circuit was changed.	Check for any changes in the secondary loop.
		Incorrect measurement of power factor.	Make sure the current wires and voltage sense leads are secure, with the correct terminals of the firing card.
		Current coil resistor on firing card or load resistor on SCR assembly is not connected properly.	Confirm that resistor(s) are properly seated and connected.
		Power factor values programmed incorrectly.	Check the power factor settings.
Power Factor Limit (See p. 6-4)	The power factor detected while executing a weld schedule does not fall within the desired range. Also check for poor part fitup, arcing and problems with factors such as the gun timing.	Any variation in the welding circuit inductance is reflected in the power factor.	Check for any changes in the secondary loop.
		Incorrect measurement of power factor.	Make sure the current wires and voltage sense leads are secure, with the correct terminals of the firing card.
		Power factor values are programmed incorrectly.	Check the power factor settings.

Message	Explanation	Possible Cause	Remedy
Voltage Compensation Limit (See p. 6-4)	The control could not fully compensate for a drop or surge in supply line voltage.	Check the nominal contactor voltage setup parameter.	Try recalculating the nominal contactor voltage setting.
		Too much load on the line when attempting the weld.	Check line voltage.
		Adjust tap settings on the weld transformer, and/or adjust weld heat away from extreme values.	Heat may be set at too high or low % current for the control to compensate for line voltage variations. Avoid programming values of 20% or secondary current that is too low.
		Steppers are pushing the total % current (programmed current + boost) over the threshold.	Adjust the stepper boost.
Insufficient Line Voltage (See p. 6-4)	The weld initiate was removed, or time expired while the control was waiting for the programmed line voltage in Function #72 or #73.	Overloading of the weld bus.	Re-distribute weld bus load.
		Brown-outs of the power source.	Measure bus voltage with no load. Ensure that it is providing the necessary voltage. (Confirm this by observing the low line voltage on the Weld Data display of the DEP.)

Message	Explanation	Possible Cause	Remedy
<p>Isolation Contactor Off When Needed</p> <p>(See p. 6-5)</p>	<p>The isolation contactor was not pulled in by the control when required by the weld schedule.</p>	<p>The instruction to activate the isolation contactor (Function #52) was missing from the weld schedule.</p>	<p>Verify that the schedule contains Function #52.</p>
		<p>Isolation contactor is controlled by the weld control and driven by a single solid-state relay. The weld processor signal is based on the status of the CONTROL STOP and WELD/NO WELD Inputs. (Voltage must be present at these inputs to allow the weld processor to open or close the isolation contactor.)</p>	<p>Use the I/O Status display on the DEP-100S to verify that the inputs are high (1) when required.</p>
		<p>For externally-powered controls, an internal control transformer fuse is blown.</p>	<p>Verify that the Ready to Weld signal was high (1) when required.</p>
		<p>The solid-state relay is faulty.</p>	<p>Check fuses; replace as necessary.</p>
		<p>The instruction to activate the isolation contactor was executed, but the control was unable to pull in the contactor, due to incorrect or loose wiring to the output module.</p>	<p>Replace relay.</p>
		<p>Faulty output module.</p>	<p>Check the wiring diagram that came with your control for proper I/O designations. Verify that all wiring connections are secure.</p>
		<p>Replace module.</p>	

Message	Explanation	Possible Cause	Remedy
No Zero-Crossing Sync (See p. 6-5)	The control is unable to synchronize with the AC line voltage.	No incoming voltage to the control cabinet.	Verify incoming power to the control's circuit breaker with a volt meter. If no power, check for circuit break shunt trip or other errors.
		Failure of the incoming power signal to reach the firing card, (through its J3 connector) due to loose or faulty wiring.	Check for loose wiring at the J3 connector on the firing card. Repair as necessary.
		Zero-crossing signal is not reaching the weld processor card, due to loose cable or bad connector between the firing card and the weld processor card.	Secure the cable between the firing card and processor card. Check for bad connector, and replace as necessary.
		Faulty firing card.	Replace firing card.
		Faulty weld processor card.	Replace weld processor card.
		Overloading weld bus.	Re-distribute the weld bus load.
		Brown-out of power source.	Correct power delivery problem.
Low Battery (See p. 6-5)	The battery on the back of the processor card is low or discharged.		Replace battery/processor card. <i>(The battery is soldered in place. Only qualified personnel should attempt to replace the battery in an ESD-safe environment.)</i>
High C-Factor (See p. 6-6)	The C-factor read during the weld part of the schedule exceeded the value programmed in Function #97.	Unusual conditions in the secondary.	Check for causes of shunting or conducting water.
		The High C-factor limit was programmed too low.	Raise the high C-factor limit.
Low C-Factor (See p. 6-6)	The C-factor read during the weld part of the schedule fell below the value programmed in Function #97.	Unusual conditions in the secondary.	Check for worn cables, loose connections, low air pressure or other causes of decreased secondary current.
		The Low C-factor limit was programmed too high.	Lower the Low C-factor limit.
		Tips closing too slowly, due to a dirty or poorly-lubricated cylinder.	Check for sticking gun cylinder.

Message	Explanation	Possible Cause	Remedy
System Cooling (See p. 6-6)	TRANSFORMER OVER-TEMPERATURE input was not active when required by the control, or the SCR thermal switch was tripped.	Defective SCR thermostat.	Replace thermostat.
		Customer-supplied device did not activate the TRANSFORMER OVER-TEMPERATURE input when required.	Check device.
		Loose/incorrect connections to input module or in circuit.	Check for proper wiring
		Insufficient water flow.	Check the water flow, access holes, hoses and filters (if used).
		Faulty input module.	Replace module.
Heat Cycle Limit (See p. 6-6)	The control reached the programmed limit of consecutive weld cycles where conduction was detected.	Weld schedule programming was incorrect.	Lower the number of cycles where the weld control is firing. Your application does not need the Heat Cycle Limit setup parameter. (To disable this parameter, set it to 0.)
		Faulty weld processor card.	Replace weld processor card.
Weld Interrupt (See p. 6-6)	The control entered No Weld mode while executing a weld schedule.	Robot or PLC ladder logic de-activated the WELD/NO WELD Input.	Check robot or PLC ladder to verify that the input is being held HIGH throughout the weld schedule. (Use the DEP's I/O Status display to monitor the status of this input.) Also check the DEP I/O status.
		Incorrect or loose wiring to the input module.	Check for proper I/O designations. Verify that all wiring connections are secure.
		Faulty input module.	Replace input module.
I/O System Timeout (See p. 6-6)	The SLC processor stopped scanning.	The SLC will stop scanning if a CPU fault occurs at the SLC processor.	Clear fault and cycle power.
I/O Update Timeout (See p. 6-6)	The weld and SLC processors detected a loss of communications for a specified amount of time while executing a weld schedule.	Bad connectors or improper seating of the weld processor or the SLC processor in the chassis.	Remove power from the rack. Inspect the SLC and weld processor connections. Re-seat and restore power.
		Weld processor firmware and SLC ladder logic are incompatible.	Verify compatibility. Correct as necessary.

Message	Explanation	Possible Cause	Remedy
SLC Not in Run Mode	The SLC processor moved into Program Mode while the control was executing a weld schedule.	The SLC processor experienced a CPU fault.	Clear fault and cycle power.
		The SLC was physically moved out of Run mode.	Switch the SLC processor back into Run Mode
		Faulty SLC processor.	Replace module.
RIO Comm Error/Not in Run Mode	The host PLC (connected to the RIO link) moved out of Run Mode, or had a fatal communication error while the control was sequencing.	Incorrect wiring from the 3005 RIO module to the PLC.	Check for proper wiring. Verify that all connections are secure.
		The host PLC was moved out of Run Mode.	Switch host PLC back to Run Mode.
		Faulty RIO module or host PLC/scanner.	Replace as necessary.
Weld Proceed (See p. 6-7)	WELD PROCEED input did not become active when required by the control, or it was removed while the control was executing a schedule.	Faulty robot or PLC ladder logic.	Check ladder logic to verify that the input is being activated.
		Loose or incorrect wiring to the input module.	Check for proper I/O designations. Check to make sure all wiring connections are secure.
		Faulty input module.	Replace input module.
Retract Pilot Error (See p. 6-7)	The retract cylinder was not out of retract when checked by the control.	Operator error.	The input was not activated when required by the operator.
		Either the Retract Mode or the Cylinder Type setup parameters were changed, and the control must be reset.	Cycle power to the control to reset it. (The control ignores changes to these settings until power is cycled.)
		Loose or incorrect wiring to the input module.	Check for proper I/O designations. Check to make sure all wiring connections are secure.
		Faulty input module.	Replace input module.
		Faulty weld processor card.	Replace weld processor.
Isolation Contactor Not Enabled (See p. 6-8)	Isolation contactor was de-activated (opened) while the control was executing a weld schedule.	Faulty robot or PLC ladder logic.	Check robot or PLC ladder to verify that the input is being activated and held HIGH throughout the schedule.
		Loose or incorrect wiring to the input module.	Check for proper I/O designations. Check to make sure all wiring connections are secure.
		Faulty input module.	Replace module.

Message	Explanation	Possible Cause	Remedy
Control in No Weld (See p. 6-8)	The control moved from Weld Mode to No Weld Mode while executing a weld schedule.	Robot or PLC ladder logic de-activated the WELD/NO WELD input.	Check robot or PLC ladder to verify that the input is being held HIGH throughout the schedule. (Use the DEP I/O Status display to observe the status of this input.)
		Data entry device is programmed in No Weld mode.	Verify that the data entry device is in Weld Mode.
		Loose or incorrect wiring to the input module.	Check for proper I/O designations. Check to make sure all wiring connections are secure.
		Faulty input module.	Replace module.
Weld Current Shunting (See p. 6-7)	Back-feeding EMF is causing a voltage drop across the transformer, but no measurable current is flowing in the primary.	In a multi-gun configuration, guns from two different transformers or controls are touching or conducting through the work piece.	Check for touching weld guns; Remedy as necessary.
		Improper grounding of welding tool.	Insure proper grounding of the transformer, fixture and control.

Hardware Troubleshooting

9

This chapter provides a quick look-up, to let you quickly isolate the cause of a problem, and corrective actions required.

Power Supply

.

Symptom	Probable Cause	Corrective Action
Loss of power to the power supply <i>(All rack LEDs are off)</i>	The 16-pin connector on the back of the power supply is not properly connected with its mate.	Remove power from the chassis. Re-seat the power supply.
	Power to the rack was cycled too fast, causing a large current inrush and resulting in a thermal overload.	Remove power to the rack for a MINIMUM of two minutes. Then restore power.
	Blown fuse on the power supply.	Check the fuse to see if it is blown. Replace if necessary.
	Line power is not connected to the power supply.	Verify that line power is connected to the power supply.
	Improper voltage jumper setting.	Check the jumper setting to verify it matches the input voltage.
	Defective power supply.	Replace power supply.

SLC Processor

• • • • • • • • • •

Symptom	Probable Cause	Corrective Action
Inadequate power or loss of power to the SLC Processor <i>(All LEDs are off)</i>	Line power is not connected to the power supply.	Verify that line power has been connected to the power supply. Check the jumper setting to verify that it matches the input voltage.
	Blown fuse on the power supply.	Check the fuse. Replace if necessary.
	Power to the rack has been cycled too fast, causing a large current inrush resulting in a thermal overload.	Remove power to the rack for a minimum of two minutes. Then restore power.
	Defective power supply.	Monitor the line power to chassis power for possible transient or shorting.
		Replace power supply.
Inadequate or no power to the SLC processor <i>(CPU Fault LED is on)</i>	Improper voltage jumper setting.	Check the jumper setting on the power supply. Verify that it matches the input voltage.
SLC Processor not in Run Mode <i>(All SLC LEDs are off)</i>	Improper mode selected.	Verify the processor mode selected. If in Program or Test mode, return to Run Mode.
	Line power out of range.	Check the jumper setting on the power supply. Verify that it matches the input voltage.
	Bad connectors or improper seating of the power supply and/or processor in the chassis.	Remove power and inspect the power supply and SLC processor connections.
		Remove power from the chassis and re-seat modules.
	Defective processor, power supply or chassis.	Try to select Run Mode on processor in existing chassis. If unsuccessful, move the processor to another chassis. Apply power, configure and select Run Mode again. If unsuccessful, replace processor. If successful, replace the chassis.
Try the existing power supply in test chassis. If unsuccessful, replace the power supply.		

Symptom	Probable Cause	Corrective Action
Controller is inoperable, but no major CPU faults are detected (<i>PC Run LED is on</i>)	Defective I/O devices or I/O wiring.	Test inputs and outputs, according to the I/O Troubleshooting section.
CPU Fault (<i>CPU Fault LED is blinking</i>)	CPU Memory Error.	Cycle power.
	Faulty memory module.	Remove power, then remove memory module from the processor. Re-install the processor and re-apply power to the power supply. If the CPU Fault LED changes to flashing, replace the existing memory module.
	Faulty processor or power supply.	Place the processor in another chassis and cycle power. If a steady CPU Fault LED re-appears, replace the processor. If CPU Fault LED clears, monitor the line power to the power supply in the existing system. Replace the power supply if the line power checks OK.
	Processor memory module installed incorrectly.	If upgrading the processor ladder, verify that the logic chip is properly seated.
	SLC ladder logic and weld processor firmware are incompatible.	Verify compatibility; correct as necessary. If not known, contact your WTC representative for assistance.
	One or more cards in rack is not properly seated or positioned.	Verify card position using control configuration sticker (inside control door). Remove power and re-seat module.
	jumper settings on the RIO card specify the incorrect RIO rack size.	Verify that the RIO rack size and jumper positions are correct. (See "Selecting the Rack Size" on page 2-6 for the correct jumper positions for each size of card rack.)
The SLC processor will not retain a program when it is loaded. (<i>CPU Fault LED is blinking</i>)	Excessive draw on the +24 VDC power supply.	Check for incorrect or shorted I/O wiring.
CPU error with Low/ no battery backup (<i>CPU Fault LED flashing and Battery Low LED is on</i>)	Loss of RAM during power-down period.	Verify that battery on the SLC processor is connected.
		Replace battery.

Weld Processor

• • • • • • • • • •

Symptom	Probable Cause	Corrective Action
Inadequate or no power to the weld processor <i>(Power supply LED is on)</i>	Bad connectors or improper seating of power supply and/or weld processor in the chassis.	Remove power and inspect the power supply and weld processor connections. Remove power from the chassis and re-seat modules.
	Power to the rack has been cycled too fast, causing a large current inrush resulting in a thermal overload.	Remove power from the rack for AT LEAST two minutes. Then restore power.
	Blown fuse on the power supply.	Check the fuse. Replace if necessary.
	Line power is not connected to the power supply.	Verify that line power is connected to the power supply.
	Improper voltage jumper setting.	Check the jumper setting to verify it matches the input voltage.
Loss of RAM memory <i>(Batt LED is on)</i>	The battery on the weld processor card is low or dead.	Replace the battery on the weld processor card. <i>(The battery is soldered in place. Only qualified personnel should attempt battery replacement in an ESD-safe environment.)</i>
Weld processor and SLC processor cannot communicate <i>(CPU Fault LED on SLC processor is on)</i>	Bad connectors or improper seating of the weld processor or SLC processor in the chassis.	Remove power. Inspect the SLC processor and weld processor connections. Then cycle power. Remove power from the chassis, re-seat modules and restore power.
	Weld processor firmware and SLC ladder logic are incompatible.	Verify compatibility; correct as needed. If not known, consult your WTC representative for assistance.

Symptom	Probable Cause	Corrective Action
Control and DEP-100S cannot communicate <i>(DEP and MedLAN LEDs may be off or blinking)</i>	Bad connection between weld processor and DEP-100S.	Check connection. Verify that it is secure.
		Check for bad/faulty connector and/or cable.
		Cycle power.
	If networking, no network power supply or no external 120 VAC source connected to the power supply.	Make sure you have a network power supply and that external 120VAC is connected.
	Faulty DEP-100S, WTC processor, or network power pack.	Replace as necessary.
	Incorrect network address for weld control.	Verify the welder ID and network address of the device.
Communication over the MedLAN channel is inoperable. <i>(MedLAN LEDs may be off or blinking)</i>	Improper or loose MedLAN wiring.	Check for secure and correct wiring.
	Two or more controls have the same network address number.	Check MedLAN address of each control.
	Faulty WTC processor, faulty DEP-100S or faulty network power pack.	Replace as necessary.

RIO Network Module

• • • • • • • • • •

Symptom	Possible Cause	Corrective Action
Inadequate or no power to the RIO module <i>(All RIO LEDs are off)</i>	Line power is not connected to the power supply.	Verify that line power has been connected to the power supply.
		Check jumper settings on the power supply. Verify that it matches the input voltage.
	Blown fuse on the power supply.	Check the fuse. Replace if necessary.
	Defective power supply.	Monitor the line power to the chassis power for possible transient or shorting.
		Replace power supply.
Bad connectors or improper seating of the power supply and/or RIO module in the chassis.	Remove power. Inspect the power supply and RIO module connections.	
	Remove power from the chassis. Re-seat modules.	
Loss of communications between weld control and host PLC <i>(Fault LED is on)</i>	Internal fault.	Cycle power to the I/O chassis. Replace the RIO module if the LED remains lit after power up.
Loss of communications between weld control and host PLC <i>(Fault LED is blinking)</i>	Configuration error.	Verify that the DIP switch settings are correct. Confirm that the I/O group and rack size settings are compatible. Also verify that the settings for rack address are correct.
Loss of communications between weld control and host PLC <i>(Comm LED is blinking)</i>	RIO host's processor is in Program/Test Fault mode.	Check for RIO host's processor error. Correct condition(s) as necessary, and cycle power.

Symptom	Possible Cause	Corrective Action
Loss of communications between weld control and host PLC (Comm LED is off)	RIO host's processor is not connected to scanner.	Check that the scanner is properly installed in the rack.
	RIO host's processor rack inhibited.	Check RIO host's processor rack integrity. Correct any problem and cycle power to the 3005 RIO module.
	No communication between the RIO host's processor and the 3005 RIO module.	Verify that the baud rate of the 3005 RIO matches the scanner's baud rate.
		Check the cables between the RIO host's processor and the 3005 RIO module.
	Check the 3005 RIO module for proper installation.	

Combination I/O:

.

Input Module

LED	Symptom	Input State	Probable Cause	Corrective Action
ON	Input device will not turn off.	On, closed or active	Device is shorted or damaged.	Verify device operation. Replace if necessary.
ON	SLC program operates as though input is off.	On, closed or active.	Input circuit is damaged.	Verify proper wiring. Try other input circuits; replace if necessary.
ON	SLC program operates as though input is on and/or the input circuit will not turn off.	Off, open, or inactive.	Input device off-state leakage current exceeds input circuit specifications.	Check device and input circuit specifications. Use load resistor to bleed off current.
			Input device is shorted or damaged.	Verify device operation. Replace if necessary.
			Input circuit is damaged.	Verify proper wiring. Try other input circuit; replace module if needed.

LED	Symptom	Input State	Probable Cause	Corrective Action
OFF	SLC program operates as though input is off and/or the input circuit will not turn on.	On, closed, or active.	Input circuit is incompatible.	Check specification and sink/source compatibility (if DC input only).
			Low voltage across the input.	Check voltage across input circuit; check source voltage.
			Incorrect wiring or open circuit.	Check wiring and common connections.
			Input signal turn on time too fast for input circuit.	Check timing specifications.
			Input circuit is damaged.	Verify wiring and try other input circuit. Replace module.
OFF	Input device will not turn on.	Off, open or inactive.	Input device is shorted or damaged.	Verify operation and replace if necessary.
OFF	SLC program operates as though it is on.	Off, open or inactive.	Input circuit is damaged.	Verify proper wiring. Try other input circuit; replace module, if necessary.

Output Module

LED	Symptom	Input State	Probable Cause	Corrective Action
ON	SLC program indicates that the output circuit is off, or the output circuit will not turn off.	On or energized.	Output circuit is damaged.	Verify proper wiring. Try other circuit; replace module if necessary.
ON	Output device will not turn on and the SLC program indicates that it is on.	Off or de-energized.	Output device is incompatible.	Check specifications and sink/source compatibility (if DC output only).
			Incorrect wiring or open circuit.	Check wiring and common connections.
			Output device is damaged.	Check wiring, try other output circuit and replace module, if necessary.
			Low or no voltage across the load.	Measure the source voltage and check specifications.
ON	Output device will not turn off and the SLC program indicates that it is off.	On or energized	Output device is incompatible.	Check specifications.
			Incorrect wiring.	Check wiring, disconnect from the SLC and verify device operation.
			Output device is damaged.	Verify device operation. Replace device, if needed.
			Output circuit is damaged.	Check wiring. Try the other output circuit; replace the module if necessary.
			Output circuit off-state leakage current may exceed output device specification.	Check specification. Use load resistor to bleed off leakage current.
OFF	SLC program indicates that the output circuit is on or the output circuit will not turn on.	Off or de-energized.	Output circuit is damaged.	Verify proper wiring; try other circuit. Replace module if necessary.

Solving Typical Problems

• • • • • • • • • • •

This table describes some of the typical problems you may see in the field. The recommended procedure to troubleshoot each problem is provided.

Problem	Possible Cause	Possible Solution
Circuit breaker trips on power-up.	SHUNT TRIP output on the I/O is becoming active.	If NO, replace output module.
		If YES, check the following: - Primary transformer cables grounded? - SCR breaking over at low potential, or shorted?
	Firing card is faulty.	Replace firing card.
	Circuit breaker is faulty.	Replace circuit breaker.
Circuit breaker trips while welding	The magnetic trip on the circuit breaker is set too low. (This causes the control to trip during the weld time of a schedule.)	Adjust the circuit breaker's magnetic trip threshold.
	The SCR is breaking over at low potential or shorted.	Replace SCR.
	SHUNT TRIP output on the I/O module is active when the SCR is not shorted.	Faulty firing card or I/O module. Replace as necessary.
	Faulty firing card.	Replace firing card.
	Intermittent ground.	Replace circuit breaker.

Problem	Possible Cause	Possible Solution
Control does not initiate a weld schedule.	Control is not receiving BINARY SELECT inputs.	Check the device supplying the inputs. Check the I/O module and check input supply voltage to the I/O module. Check the I/O Status Display at the DEP.
	The INITIATE WELD input is not being supplied with the BINARY SELECT inputs. (Certain applications require this.)	Check the device supplying the Initiate Weld input. Check the I/O module and the input supply voltage to the I/O module. Check the I/O Status Display at the DEP.
	The PARITY input is required (to supply an ODD number of inputs). Certain applications require this input when the total number of inputs in the weld initiate is an even number.	Check the device supplying the PARITY input. Check the I/O module and the input supply voltage to the I/O module. Check the I/O Status Display at the DEP.
	Control is in retract, and the setup parameters specify that initiation is INHIBITED from retract.	Check the setup parameters. Either take the control out of retract before initiating, or change the Initiation from Retract setup parameter. (You must also cycle power after changing the state of the retract setup parameters.)
	Control has detected a fault condition. (Faults must be reset before initiating a schedule when the setup parameters INHIBIT initiation on Faults.)	Check the data entry device to determine which fault condition was detected. Clear the fault(s) and re-initiate. <i>or</i> Change the setup parameters to ALLOW initiation when fault conditions are active.
	Improper or loose wiring.	Verify that connections are correct and wiring is secure. I/O designations are listed in the drawing packet provided with the control. Also check input supply voltage to the I/O module.
	Faulty I/O module or weld processor.	Replace as necessary.

Problem	Possible Cause	Possible Solution
Control not responding to data entry device	Bad connection between weld processor and DEP-100S.	Check the connection between the weld processor and DEP-100S. Check for faulty connector or cable.
	If networking, there is no network supply or external 120 VAC connected to the power supply. (Required to power the DEP-100S.)	Assure that the network power supply is connected and external 120 VAC is supplied.
	If networking, check for improper or loose wiring at MedLAN connection.	Check for secure and proper wiring. Refer to MedLAN wire designations described in "Providing MedLAN Connections" on page 2-9.
	Two controls share the same MedLAN address.	Check each control's address. Verify that each has a unique address.
	Verify that the data entry device software is compatible with the weld processor. (Consult your WTC representative for assistance.)	Update software.
	Faulty weld processor, faulty DEP-100S or faulty network power pack.	Replace as necessary.
Control sequences without firing SCR	The control is in No Weld.	Check the status of the WELD/NO WELD input. Verify that the control and all data entry devices are in Weld mode.
	A fault occurred, causing the control to complete the weld schedule in No Weld.	Check the data entry device to determine any fault conditions. Clear the fault(s), correct the problem and re-initiate.
	Programming error.	Check the weld schedule being initiated to verify that the weld schedule contains a weld function. Also verify that the weld function has a value greater than zero for number of cycles.
	Weld processor is not sending firing signals to the firing card. (Bad connection between weld processor and firing card.)	Remove power from the chassis and check for faulty connectors or cables. Re-seat modules and cycle power.
	Is the firing card receiving firing signals? (<i>Is the Firing LED on the card on during the weld function?</i>)	If YES , check the firing card and SCR wiring. Replace as necessary. Also check to see if firing into an open primary or secondary of the weld transformer. (Check the power factor settings.) If NO , check the weld processor card and replace as necessary.

Problem	Possible Cause	Possible Solution
I/O not responding as expected	Problem with the I/O.	Check the device supplying the input or receiving the output.
		Incorrect or loose wiring to the input or output module.
		Faulty input or output module.
Isolation contactor not being pulled in	The weld schedule does not contain the function to activate the isolation contactor (Function #52).	Check the weld schedule to confirm that it contains Function #52.
	The isolation contactor is driven by a single solid-state relay (based on the status of the CONTROL STOP and WELD/NO WELD inputs). Voltage must be present at these inputs to allow the weld processor to open or close the isolation contactor.	Use the I/O Status display on the DEP-100S to verify that the inputs are HIGH (= 1).
	The solid-state relay is faulty.	Replace relay.
	If the control is externally-powered, one of the internal control transformer fuses may be blown.	Check fuses. Replace as necessary.
	The control was unable to pull in the isolation contactor due to incorrect or loose wiring to the output module.	Check the wiring diagram that came with your control for proper I/O designations. Make sure all connections are secure.
	Isolation contactor is not being held in between weld sequence.	Check the I/O point enabling the ISOLATION CONTACTOR SAVER Input.
		Check the setting of the Isolation Contactor Delay timer in the setup parameters.
	Faulty output module.	Replace module.
No current reading (10 A. or less)	Did the control weld?	If NO , see <i>Control sequences without firing</i> on page 9-12. If YES , check for part fit-up, foreign material between electrodes and work piece, electrode pressure and tooling.
	Bad connection between current coil and firing card.	Check for proper and secure wiring connections between firing card and current coil.
	Faulty firing card.	Replace firing card.

Problem	Possible Cause	Possible Solution
No line voltage reading or no zero-crossing.	Main breaker switch is OFF.	Turn on the breaker.
	No 480/600 VAC is connected to the top of the breaker.	Verify that supply voltage (480 or 600 VAC) is connected to the top of the breaker. (On a single-pack control, supply voltage is connected at L1 and L2.)
	Faulty circuit breaker.	Supply voltage IS connected to the breaker. Verify that power is available on the load side of the circuit breaker.
	Faulty cable between firing and processor card.	Replace cable.
	If "No Zero Crossing Sync" occurs during a weld, there may be a loose connection or weak welding bus.	Tighten loose connections. Install weld bus capacitors. Re-distribute loads on the weld bus. Install a stiffer power supply.
	Faulty firing card.	Replace firing card.
	Faulty weld processor.	Replace weld processor.

Application Note: Cascade Welding

Scope This application note is intended for customers using a single AC weld control to fire multiple weld guns. The door of your welding control will be labeled "AC" or "MFDC". This note does NOT apply to MFDC welding controls.

Cascade Welding Information for AC Products

• • • • •

Background Information It is possible to operate more than one welding gun with a single weld control, if the welding guns are operated one at a time in succession. This is called cascade welding.

This application note gives some guidelines on setting-up and using cascade welding systems with a single-phase AC welding control.

Parallel Cascade Method

There are two possible ways to do cascade welding. The first, and simplest method is to hook up (L2) to three welding transformers, each attached to a welding gun. Then connect the output (H) of a single AC welding control in parallel (See Figure 1).

Figure 1: A system with three transformers and three welding guns on a single control.

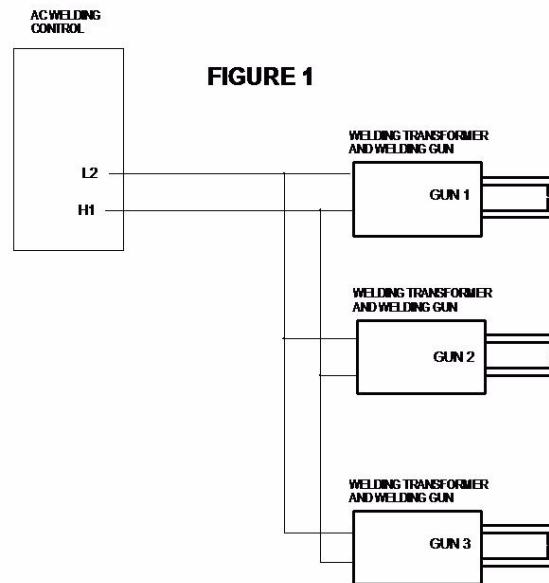

- To weld on gun #1: gun 1 must be closed and guns 2 and 3 must be left open.
- To weld on gun #2: gun 2 must be closed and guns 1 and 3 must be left open.

- To weld on gun #3: gun 3 must be closed and guns 1 and 2 must be left open.

When multiple welding transformers are connected in parallel to one welding control as shown in Figure 1, some additional rules should be followed:

1. No more than three weld transformers should be used.
2. The delayed firing option should always be turned ON in the setup parameters, regardless of what type transformers are used.
3. The control should be operated in primary constant-current mode ONLY! (Any other mode of operation is likely to cause intermittent circuit breaker trips and/or poor weld quality.)
4. Poly-pulse or pulsation welding should not be used.

Failure to follow these guidelines will result in diminished weld quality, sticking electrodes, increased downtime caused by intermittent circuit breaker trips and may void your warranty.

Multiple Output Cascade Method

Figure 2: AC welding control with three outputs, connected to three welding transformers with three welding guns

Another example of cascade welding is to use a single weld control which has multiple outputs, one for each welding transformer (See Figure 2).

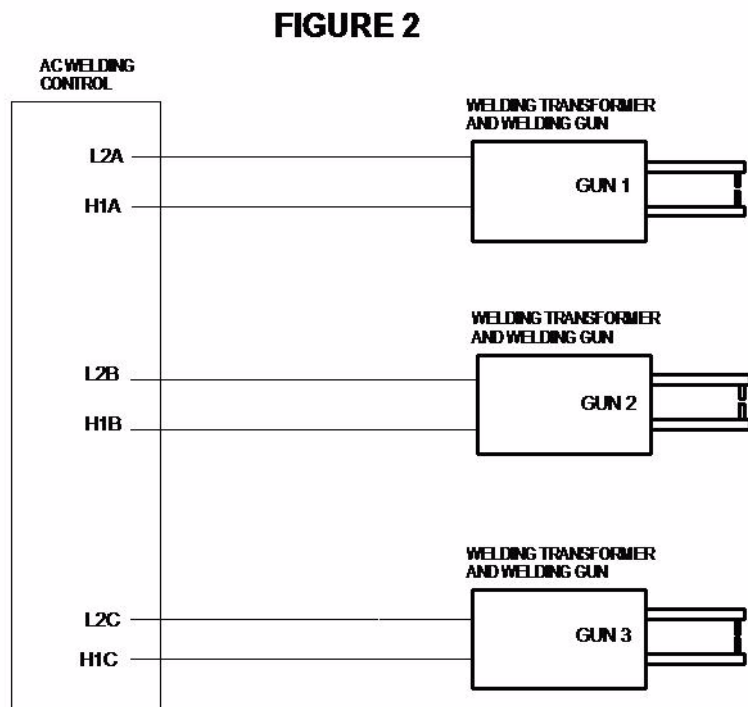

In this system, all three welding guns have the ability to be closed at the same time. However, the welding control applies current to the welding transformers in succession.

The Differences Between Method 1 and 2

The cascade system in Figure 1 is the least expensive, but it cannot make welds as quickly as the system in Figure 2 due to the extra time needed to allow each welding gun to open and close. The cascade system of Figure 1 is also limited, for practical reasons, to three welding guns or less. For these reasons, the system in Figure 2 is more common.

Weld Schedules in Cascade Welds

.

When programming weld schedules for cascade welding, it is best to use a separate weld schedule for each weld. Separate weld schedules provide a greater degree of control and monitoring on each weld and generally make it easier to achieve good weld quality.

Production line conditions may not allow time for a separate weld schedule for each weld. It may become necessary to make two or more cascade welds within the same weld schedule. When multiple welds are made within the same weld schedule, all of the welds should be the same weld size, be in the same material/stackup, and should use the same size welding transformer and welding gun.

Appendix: I/O Image Tables

RIO Image Tables

.

Host PLC Output Image Table (Welder Inputs):

Bits		Word 0	Word 1	Word 2	Word 3	Word 4	Word 5	Word 6	Word 7
Dec.	Octal	Weld Control Bits (WCU #1)	Weld Control Bits (WCU #3) ^a	Weld Control Bits (WCU #4)	Weld Control Bits (WCU #6)	Weld Control Bits (WCU #7)	Weld Control Bits (WCU #9)	Weld Control Bits (WCU #10)	Weld Control Bits (WCU #12)
00		BINARY SELECT #1	BINARY SELECT #1	BINARY SELECT #1	BINARY SELECT #1	BINARY SELECT #1	BINARY SELECT #1	BINARY SELECT #1	BINARY SELECT #1
01		BINARY SELECT #2	BINARY SELECT #2	BINARY SELECT #2	BINARY SELECT #2	BINARY SELECT #2	BINARY SELECT #2	BINARY SELECT #2	BINARY SELECT #2
02		BINARY SELECT #4	BINARY SELECT #4	BINARY SELECT #4	BINARY SELECT #4	BINARY SELECT #4	BINARY SELECT #4	BINARY SELECT #4	BINARY SELECT #4
03		BINARY SELECT #8	BINARY SELECT #8	BINARY SELECT #8	BINARY SELECT #8	BINARY SELECT #8	BINARY SELECT #8	BINARY SELECT #8	BINARY SELECT #8
04		BINARY SELECT #16	BINARY SELECT #16	BINARY SELECT #16	BINARY SELECT #16	BINARY SELECT #16	BINARY SELECT #16	BINARY SELECT #16	BINARY SELECT #16
05		INITIATE WELD	INITIATE WELD	INITIATE WELD	INITIATE WELD	INITIATE WELD	INITIATE WELD	INITIATE WELD	INITIATE WELD
06		WELD INPUT	WELD INPUT	WELD INPUT	WELD INPUT	WELD INPUT	WELD INPUT	WELD INPUT	WELD INPUT
07		STEPPER RESET	STEPPER RESET	STEPPER RESET	STEPPER RESET	STEPPER RESET	STEPPER RESET	STEPPER RESET	STEPPER RESET
Dec.	Octal	Weld Control Bits (WCU #2)	Global (Enclosure) Bits	Weld Control Bits (WCU #5)	Spare Bits	Weld Control Bits (WCU #8)	Spare Bits	Weld Control Bits (WCU #11)	Spare Bits

Bits	Word 0	Word 1	Word 2	Word 3	Word 4	Word 5	Word 6	Word 7
08	BINARY SELECT #1	CONTROL STOP	BINARY SELECT #1	Spare	BINARY SELECT #1	Spare	BINARY SELECT #1	Spare
09	BINARY SELECT #2	ENABLE CONTACTOR SAVER	BINARY SELECT #2	Spare	BINARY SELECT #2	Spare	BINARY SELECT #2	Spare
10	BINARY SELECT #4	GLOBAL STEPPER RESET	BINARY SELECT #4	Spare	BINARY SELECT #4	Spare	BINARY SELECT #4	Spare
11	BINARY SELECT #8	GLOBAL FAULT RESET	BINARY SELECT #8	Spare	BINARY SELECT #8	Spare	BINARY SELECT #8	Spare
12	BINARY SELECT #16	Reserved ^b	BINARY SELECT #16	Spare	BINARY SELECT #16	Spare	BINARY SELECT #16	Spare
13	INITIATE WELD	Reserved	INITIATE WELD	Spare	INITIATE WELD	Spare	INITIATE WELD	Spare
14	WELD INPUT	Reserved	WELD INPUT	Spare	WELD INPUT	Spare	WELD INPUT	Spare
15	STEPPER RESET	Reserved	STEPPER RESET	Spare	STEPPER RESET	Spare	STEPPER RESET	Spare

- a. To use the tri-pack enclosure as a dual-pack, refer to “Local and Safety I/O” for a description of the WCU #3 NOT PRESENT input (page 3-2). (When this input is held HIGH, WCU #3 is disabled and the weld processor card can be removed from the chassis.)
- b. Reserved for RIO communication status and Host PLC status.

Host PLC Input Image Table (Welder Outputs)

Bits		Word 0	Word 1	Word 2	Word 3	Word 4	Word 5	Word 6	Word 7
Dec.	Octal	Weld Control Bits (WCU #1)	Weld Control Bits (WCU #3) ^a	Weld Control Bits (WCU #4)	Weld Control Bits (WCU #6)	Weld Control Bits (WCU #7)	Weld Control Bits (WCU #9)	Weld Control Bits (WCU #10)	Weld Control Bits (WCU #12)
00	0	I/O ACTIVE	I/O ACTIVE	I/O ACTIVE	I/O ACTIVE	I/O ACTIVE	I/O ACTIVE	I/O ACTIVE	I/O ACTIVE
01	1	WELD IN PROGRESS	WELD IN PROGRESS	WELD IN PROGRESS	WELD IN PROGRESS	WELD IN PROGRESS	WELD IN PROGRESS	WELD IN PROGRESS	WELD IN PROGRESS
02	2	NO FAULT	NO FAULT	NO FAULT	NO FAULT	NO FAULT	NO FAULT	NO FAULT	NO FAULT
03	3	ALERT	ALERT	ALERT	ALERT	ALERT	ALERT	ALERT	ALERT
04	4	END OF STEPPER	END OF STEPPER	END OF STEPPER	END OF STEPPER	END OF STEPPER	END OF STEPPER	END OF STEPPER	END OF STEPPER
05	5	STEPPER IS RESET	STEPPER IS RESET	STEPPER IS RESET	STEPPER IS RESET	STEPPER IS RESET	STEPPER IS RESET	STEPPER IS RESET	STEPPER IS RESET
06	6	WELD COMPLETE	WELD COMPLETE	WELD COMPLETE	WELD COMPLETE	WELD COMPLETE	WELD COMPLETE	WELD COMPLETE	WELD COMPLETE
07	7	READY TO WELD	READY TO WELD	READY TO WELD	READY TO WELD	READY TO WELD	READY TO WELD	READY TO WELD	READY TO WELD

- a. To use the tri-pack enclosure as a dual-pack, refer to “Local and Safety I/O” for a description of the WCU #3 NOT PRESENT input (page 3-2). (When this input is held HIGH, WCU #3 is disabled and the weld processor card can be removed from the chassis.)
- b. Reserved for RIO communication status.

Dec.	Bits	Word 0	Word 1	Word 2	Word 3	Word 4	Word 5	Word 6	Word 7
		Weld Control Bits (WCU #2)	Global (Enclosure) Bits	Weld Control Bits (WCU #5)	Spare Bits	Weld Control Bits (WCU #8)	Spare Bits	Weld Control Bits (WCU #11)	Spare Bits
08	10	I/O ACTIVE	CONTACTOR IS OPEN	I/O ACTIVE	SPARE	I/O ACTIVE	SPARE	I/O ACTIVE	SPARE
09	11	WELD IN PROGRESS	STEPPER APPROACHING MAXIMUM	WELD IN PROGRESS	SPARE	WELD IN PROGRESS	SPARE	WELD IN PROGRESS	SPARE
10	12	NO FAULT	SPARE	NO FAULT	SPARE	NO FAULT	SPARE	NO FAULT	SPARE
11	13	ALERT	SPARE	ALERT	SPARE	ALERT	SPARE	ALERT	SPARE
12	14	END OF STEPPER	Reserved ^{a, b}	END OF STEPPER	SPARE	END OF STEPPER	SPARE	END OF STEPPER	SPARE
13	15	STEPPER IS RESET	NOT IN RUN MODE ^c	STEPPER IS RESET	SPARE	STEPPER IS RESET	SPARE	STEPPER IS RESET	SPARE
14	16	WELD COMPLETE	COMMUNICATIONS ERROR ^c	WELD COMPLETE	SPARE	WELD COMPLETE	SPARE	WELD COMPLETE	SPARE
15	17	READY TO WELD	Reserved ^e	READY TO WELD	SPARE	READY TO WELD	SPARE	READY TO WELD	SPARE

- a. To use the tri-pack enclosure as a dual-pack, refer to “Local and Safety I/O” for a description of the WCU #3 NOT PRESENT input (page 3-2). (When this input is held HIGH, WCU #3 is disabled and the weld processor card can be removed from the chassis.)
- b. Reserved for RIO communication status.
- c. Weld PLC Processor not in Run Mode.
- d. Communications error between 3005 RIO Network Module and Host PLC.
- e. Reserved for RIO communication status

Bits		Word 0	Word 1	Word 2	Word 3	Word 4	Word 5	Word 6	Word 7
Dec.	Octal	Weld Control Bits (WCU #2)	Global (En-closure) Bits	Weld Control Bits (WCU #5)	Spare Bits	Weld Control Bits (WCU #8)	Spare Bits	Weld Control Bits (WCU #11)	Spare Bits
08	10	BINARY SELECT #1	CONTROL STOP	BINARY SELECT #1	SPARE	BINARY SELECT #1	SPARE	BINARY SELECT #1	SPARE
09	11	BINARY SELECT #2	ENABLE CONTACTOR SAVER	BINARY SELECT #2	SPARE	BINARY SELECT #2	SPARE	BINARY SELECT #2	SPARE
10	12	BINARY SELECT #4	GLOBAL STEPPER RESET	BINARY SELECT #4	SPARE	BINARY SELECT #4	SPARE	BINARY SELECT #4	SPARE
11	13	BINARY SELECT #8	GLOBAL FAULT RESET	BINARY SELECT #8	SPARE	BINARY SELECT #8	SPARE	BINARY SELECT #8	SPARE
12	14	BINARY SELECT #16	Reserved ^a	BINARY SELECT #16	SPARE	BINARY SELECT #16	SPARE	BINARY SELECT #16	SPARE
13	15	INITIATE WELD	Reserved	INITIATE WELD	SPARE	INITIATE WELD	SPARE	INITIATE WELD	SPARE
14	16	WELD INPUT	Reserved	WELD INPUT	SPARE	WELD INPUT	SPARE	WELD INPUT	SPARE
15	17	WELD PROCEED	Reserved	WELD PROCEED	SPARE	WELD PROCEED	SPARE	WELD PROCEED	SPARE

a. Reserved for RIO communication status and Host PLC status.

Bits		Word 0	Word 1	Word 2	Word 3	Word 4	Word 5	Word 6	Word 7
Dec.	Octal	Weld Control Bits (WCU #2)	Global (Enclosure) Bits	Weld Control Bits (WCU #5)	Spare Bits	Weld Control Bits (WCU #8)	Spare Bits	Weld Control Bits (WCU #11)	Spare Bits
08	10	I/O ACTIVE	CONTACTOR IS OPEN	I/O ACTIVE	SPARE	I/O ACTIVE	SPARE	I/O ACTIVE	SPARE
09	11	WELD IN PROGRESS	STEPPER APPROACHING MAXIMUM	WELD IN PROGRESS	SPARE	WELD IN PROGRESS	SPARE	WELD IN PROGRESS	SPARE
10	12	NO FAULT	SPARE	NO FAULT	SPARE	NO FAULT	SPARE	NO FAULT	SPARE
11	13	ALERT	SPARE	ALERT	SPARE	ALERT	SPARE	ALERT	SPARE
12	14	END OF STEPPER	Reserved ^a	END OF STEPPER	SPARE	END OF STEPPER	SPARE	END OF STEPPER	SPARE
13	15	STEPPER IS RESET	NOT IN RUN MODE ^b	STEPPER IS RESET	SPARE	STEPPER IS RESET	SPARE	STEPPER IS RESET	SPARE
14	16	WELD COMPLETE	COMMUNICATIONS ERROR ^c	WELD COMPLETE	SPARE	WELD COMPLETE	SPARE	WELD COMPLETE	SPARE
15	17	READY TO WELD	Reserved ^d	READY TO WELD	SPARE	READY TO WELD	SPARE	READY TO WELD	SPARE

a. Reserved for RIO communication status.

b. Weld PLC Processor not in Run Mode.

c. Communications error between 3005 RIO Network Module and Host PLC.

d. Reserved for RIO communication status.

Bits		Word 0	Word 1	Word 2	Word 3	Word 4	Word 5	Word 6	Word 7
Dec.	Octal	Weld Control Bits (WCU #2)	Global (En-closure) Bits	Weld Control Bits (WCU #5)	Spare Bits	Weld Control Bits (WCU #8)	Spare Bits	Weld Control Bits (WCU #11)	Spare Bits
08	10	BINARY SELECT #1	CONTROL STOP	BINARY SELECT #1	SPARE	BINARY SELECT #1	SPARE	BINARY SELECT #1	SPARE
09	11	BINARY SELECT #2	ENABLE CONTACTOR SAVER	BINARY SELECT #2	SPARE	BINARY SELECT #2	SPARE	BINARY SELECT #2	SPARE
10	12	BINARY SELECT #4	GLOBAL STEPPER RESET	BINARY SELECT #4	SPARE	BINARY SELECT #4	SPARE	BINARY SELECT #4	SPARE
11	13	BINARY SELECT #8	GLOBAL FAULT RESET	BINARY SELECT #8	SPARE	BINARY SELECT #8	SPARE	BINARY SELECT #8	SPARE
12	14	PROGRAM MODE SECURITY	Reserved ^a	PROGRAM MODE SECURITY	SPARE	PROGRAM MODE SECURITY	SPARE	PROGRAM MODE SECURITY	SPARE
13	15	INITIATE WELD	Reserved	INITIATE WELD	SPARE	INITIATE WELD	SPARE	INITIATE WELD	SPARE
14	16	WELD INPUT	Reserved	WELD INPUT	SPARE	WELD INPUT	SPARE	WELD INPUT	SPARE
15	17	WELD PROCEED	Reserved	WELD PROCEED	SPARE	WELD PROCEED	SPARE	WELD PROCEED	SPARE

a. Reserved for RIO communication status and Host PLC status.

Bits		Word 0	Word 1	Word 2	Word 3	Word 4	Word 5	Word 6	Word 7
Dec.	Octal	Weld Control Bits (WCU #2)	Global (En-closure) Bits	Weld Control Bits (WCU #5)	Spare Bits	Weld Control Bits (WCU #8)	Spare Bits	Weld Control Bits (WCU #11)	Spare Bits
08	10	I/O ACTIVE	CONTACTOR IS OPEN	I/O ACTIVE	SPARE	I/O ACTIVE	SPARE	I/O ACTIVE	SPARE
09	11	WELD IN PROGRESS	STEPPER APPROACHING MAXIMUM	WELD IN PROGRESS	SPARE	WELD IN PROGRESS	SPARE	WELD IN PROGRESS	SPARE
10	12	NO FAULT	SPARE	NO FAULT	SPARE	NO FAULT	SPARE	NO FAULT	SPARE
11	13	ALERT	SPARE	ALERT	SPARE	ALERT	SPARE	ALERT	SPARE
12	14	END OF STEPPER	Reserved ^a	END OF STEPPER	SPARE	END OF STEPPER	SPARE	END OF STEPPER	SPARE
13	15	STEPPER IS RESET	NOT IN RUN MODE ^b	STEPPER IS RESET	SPARE	STEPPER IS RESET	SPARE	STEPPER IS RESET	SPARE
14	16	WELD COMPLETE	COMMUNICATIONS ERROR ^c	WELD COMPLETE	SPARE	WELD COMPLETE	SPARE	WELD COMPLETE	SPARE
15	17	READY TO WELD	Reserved ^d	READY TO WELD	SPARE	READY TO WELD	SPARE	READY TO WELD	SPARE

a. Reserved for RIO communication status.

b. Weld PLC Processor not in Run Mode.

c. Communications error between 3005 RIO Network Module and Host PLC.

d. Reserved for RIO communication status.

Bits		Word 0	Word 1	Word 2	Word 3	Word 4	Word 5	Word 6	Word 7
		Weld Control Bits (WCU #2)	Global (En-closure) Bits	Weld Control Bits (WCU #5)	Spare Bits	Spare Bits	Spare Bits	Spare Bits	Spare Bits
08	10	BINARY SELECT #1	CONTROL STOP	SPARE	SPARE	SPARE	SPARE	SPARE	SPARE
09	11	BINARY SELECT #2	ENABLE CONTACTOR SAVER	SPARE	SPARE	SPARE	SPARE	SPARE	SPARE
10	12	BINARY SELECT #4	STEPPER RESET	SPARE	SPARE	SPARE	SPARE	SPARE	SPARE
11	13	BINARY SELECT #8	FAULT RESET	SPARE	SPARE	SPARE	SPARE	SPARE	SPARE
12	14	BINARY SELECT #16	Reserved ^a	SPARE	SPARE	SPARE	SPARE	SPARE	SPARE
13	15	INITIATE WELD	Reserved	SPARE	SPARE	SPARE	SPARE	SPARE	SPARE
14	16	WELD INPUT	Reserved	SPARE	SPARE	SPARE	SPARE	SPARE	SPARE
15	17	STEPPER RESET	Reserved	SPARE	SPARE	SPARE	SPARE	SPARE	SPARE

a. Reserved for RIO communication status and Host PLC status.

RIO_4 Host PLC Input Image Table (Welder Outputs)

Bits		Word 0	Word 1	Word 2	Word 3	Word 4	Word 5	Word 6	Word 7
Dec.	Octal	Weld Control Bits (WCU #1)	Weld Control Bits (WCU #3)	Weld Control Bits	Weld Control Bits (WCU #2)	Weld Control Bits (WCU #4)	Weld Control Bits (WCU #6)	Weld Control Bits (WCU #4)	Weld Control Bits (WCU #5)
00	0	I/O ACTIVE	I/O ACTIVE	WCU #1 CONTROL STOP Fault	EXTEND WELD	I/O ACTIVE	I/O ACTIVE	CONTROL STOP Fault	EXTEND WELD
01	1	WELD IN PROGRESS	WELD IN PROGRESS	WCU #1 CURRENT LIMIT Fault	HIGH C-FACTOR LIMIT	WELD IN PROGRESS	WELD IN PROGRESS	CURRENT LIMIT Fault	HIGH C-FACTOR LIMIT
02	2	NO FAULT	NO FAULT	WCU #1 SCR MISFIRE	LOW C-FACTOR LIMIT	NO FAULT	NO FAULT	SCR MISFIRE	LOW C-FACTOR LIMIT
03	3	ALERT	ALERT	WCU #1 COMPENSA-TION Fault	SYSTEM COOLING	ALERT	ALERT	COMPENSA-TION Fault	SYSTEM COOLING
04	4	END OF STEPPER	END OF STEPPER	WCU #1 INSUFFICIENT LINE VOLTAGE Fault	DEP DISPLAY Faults	END OF STEPPER	END OF STEPPER	INSUFFICIENT LINE VOLTAGE Fault	DEP DISPLAY Faults
05	5	STEPPER IS RESET	STEPPER IS RESET	WCU #1 EXTEND WELD	SPARE	STEPPER IS RESET	STEPPER IS RESET	EXTEND WELD	SPARE
06	6	WELD COMPLETE	WELD COMPLETE	WCU #1 HIGH C-FACTOR Fault	CONTROL STOP Fault WCU #3	WELD COMPLETE	WELD COMPLETE	HIGH C-FACTOR Fault	CONTROL STOP Fault WCU #6
07	7	READY TO WELD	READY TO WELD	WCU #1 LOW C-FACTOR Fault	CURRENT LIMIT Fault WCU #3	READY TO WELD	READY TO WELD	LOW C-FACTOR Fault	CURRENT LIMIT Fault WCU #6

Bits	Word 0	Word 1	Word 2	Word 3	Word 4	Word 5	Word 6	Word 7
Dec.	Weld Control Bits (WCU #2)	Global (Enclosure) Bits	Weld Control Bits (WCU #3)	Weld Control Bits (WCU #4)	Global (Enclosure) Bits	Weld Control Bits (WCU #5)	Weld Control Bits (WCU #6)	Weld Control Bits (WCU #7)
08	I/O ACTIVE	CONTACTOR IS OPEN	WCU #1 SYSTEM COOLING	SCR MISFIRE	I/O ACTIVE	CONTACTOR IS OPEN	WCU #4 SYSTEM COOLING	SCR MISFIRE
09	WELD IN PROGRESS	WCU #1 STEPPER APPROACHING MAXIMUM	WCU #1 DEPENDENT DISPLAY Faults	COMPENSATION Fault	WELD IN PROGRESS	WCU #4 STEPPER APPROACHING MAXIMUM	WCU #4 DEPENDENT DISPLAY Faults	COMPENSATION Fault
10	NO FAULT	WCU #2 STEPPER APPROACHING MAXIMUM	WCU #1 ANA-LOG NOT IN WINDOW Fault	INSUFFICIENT LINE VOLTAGE Fault	NO FAULT	WCU #5 STEPPER APPROACHING MAXIMUM	WCU #4 ANA-LOG NOT IN WINDOW Fault	INSUFFICIENT LINE VOLTAGE Fault
11	ALERT	WCU #3 STEPPER APPROACHING MAXIMUM	WCU #2 CONTROL STOP Fault	EXTEND WELD	ALERT	WCU #6 STEPPER APPROACHING MAXIMUM	WCU #5 CONTROL STOP Fault	EXTEND WELD
12	END OF STEPPER	Reserved ^a	WCU #2 CURRENT LIMIT Fault	HIGH C-FACTOR Fault	END OF STEPPER	Reserved ^b	WCU #5 CURRENT LIMIT Fault	HIGH C-FACTOR Fault
13	STEPPER IS RESET	NOT IN RUN MODE ^c	WCU #2 SCR MISFIRE	LOW C-FACTOR Fault	STEPPER IS RESET	NOT IN RUN MODE ^d	WCU #5 SCR MISFIRE	LOW C-FACTOR Fault
14	WELD COMPLETE	COMMUNICATIONS ERROR ^e	WCU #2 COMPENSATION Fault	SYSTEM COOLING	WELD COMPLETE	COMMUNICATIONS ERROR ^f	WCU #5 COMPENSATION Fault	SYSTEM COOLING
15	READY TO WELD	Reserved ^g	WCU #2 INSUFFICIENT LINE VOLTAGE Fault	DEP DISPLAY Faults	READY TO WELD	Reserved ^h	WCU #5 INSUFFICIENT LINE VOLTAGE Fault	DEP DISPLAY Faults

a., b., g., h. Reserved for RIO communication status.

c., d. Weld PLC Processor not in Run Mode.

e., f. Communications error between 3005 RIO Network Module and Host PLC.

RIO_5 Host PLC Output Image Table (Welder Inputs):

Bits		Word 0	Word 1	Word 2	Word 3	Word 4	Word 5	Word 6	Word 7
Dec.	Octal	Weld Control Bits (WCU #1)	Spare Bits	Weld Control Bits (WCU #2)	Weld Control Bits (WCU #3)	Weld Control Bits (WCU #4)	Spare Bits	Weld Control Bits (WCU #5)	Weld Control Bits (WCU #6)
00	0	BINARY SELECT #1	SPARE	BINARY SELECT #1	BINARY SELECT #1	BINARY SELECT #1	SPARE	BINARY SELECT #1	BINARY SELECT #1
01	1	BINARY SELECT #2	SPARE	BINARY SELECT #2	BINARY SELECT #2	BINARY SELECT #2	SPARE	BINARY SELECT #2	BINARY SELECT #2
02	2	BINARY SELECT #4	SPARE	BINARY SELECT #4	BINARY SELECT #4	BINARY SELECT #4	SPARE	BINARY SELECT #4	BINARY SELECT #4
03	3	BINARY SELECT #8	SPARE	BINARY SELECT #8	BINARY SELECT #8	BINARY SELECT #8	SPARE	BINARY SELECT #8	BINARY SELECT #8
04	4	BINARY SELECT #16	SPARE	BINARY SELECT #16	BINARY SELECT #16	BINARY SELECT #16	SPARE	BINARY SELECT #16	BINARY SELECT #16
05	5	INITIATE WELD	SPARE	INITIATE WELD	INITIATE WELD	INITIATE WELD	SPARE	INITIATE WELD	INITIATE WELD
06	6	WELD INPUT	SPARE	WELD INPUT	WELD INPUT	WELD INPUT	SPARE	WELD INPUT	WELD INPUT
07	7	STEPPER RESET	SPARE	STEPPER RESET	STEPPER RESET	STEPPER RESET	SPARE	STEPPER RESET	STEPPER RESET

Bits		Word 0	Word 1	Word 2	Word 3	Word 4	Word 5	Word 6	Word 7
Dec.	Octal	Weld Control Bits	Global (En-closure) Bits	Weld Control Bits	Weld Control Bits (WCU #3)	Weld Control Bits (WCU #4)	Spare Bits	Weld Control Bits (WCU #5)	Weld Control Bits (WCU #6)
08	10	WCU #1 BINARY SELECT #32	CONTROL STOP	WCU #2 BINARY SELECT #32	BINARY SELECT #32	BINARY SELECT #32	SPARE	BINARY SELECT #32	BINARY SELECT #32
09	11	WCU #1 BINARY SELECT #64	ENABLE CONTACTOR SAVER	WCU #2 BINARY SELECT #64	BINARY SELECT #64	BINARY SELECT #64	SPARE	BINARY SELECT #64	BINARY SELECT #64
10	12	SPARE	GLOBAL STEP- PER RESET	SPARE	SPARE	SPARE	SPARE	SPARE	SPARE
11	13	SPARE	GLOBAL FAULT RESET	SPARE	SPARE	SPARE	SPARE	SPARE	SPARE
12	14	SPARE	Reserved ^a	SPARE	SPARE	SPARE	SPARE	SPARE	SPARE
13	15	SPARE	Reserved	SPARE	SPARE	SPARE	SPARE	SPARE	SPARE
14	16	SPARE	Reserved	SPARE	SPARE	SPARE	SPARE	SPARE	SPARE
15	17	SPARE	Reserved	SPARE	SPARE	SPARE	SPARE	SPARE	SPARE

a. Reserved for RIO communication status and Host PLC status.

RIO_5 Host PLC Input Image Table (Welder Outputs)

Bits		Word 0	Word 1	Word 2	Word 3	Word 4	Word 5	Word 6	Word 7
Dec.	Octal	Weld Control Bits (WCU #1)	Spare Bits	Weld Control Bits (WCU #2)	Weld Control Bits (WCU #3)	Weld Control Bits (WCU #4)	Spare Bits	Weld Control Bits (WCU #5)	Weld Control Bits (WCU #6)
00	0	I/O ACTIVE	SPARE	I/O ACTIVE	I/O ACTIVE	I/O ACTIVE	SPARE	I/O ACTIVE	I/O ACTIVE
01	1	WELD IN PROGRESS	SPARE	WELD IN PROGRESS	WELD IN PROGRESS	WELD IN PROGRESS	SPARE	WELD IN PROGRESS	WELD IN PROGRESS
02	2	NO FAULT	SPARE	NO FAULT	NO FAULT	NO FAULT	SPARE	NO FAULT	NO FAULT
03	3	ALERT	SPARE	ALERT	ALERT	ALERT	SPARE	ALERT	ALERT
04	4	END OF STEPPER	SPARE	END OF STEPPER	END OF STEPPER	END OF STEPPER	SPARE	END OF STEPPER	END OF STEPPER
05	5	STEPPER IS RESET	SPARE	STEPPER IS RESET	STEPPER IS RESET	STEPPER IS RESET	SPARE	STEPPER IS RESET	STEPPER IS RESET
06	6	WELD COMPLETE	SPARE	WELD COMPLETE	WELD COMPLETE	WELD COMPLETE	SPARE	WELD COMPLETE	WELD COMPLETE
07	7	READY TO WELD	SPARE	READY TO WELD	READY TO WELD	READY TO WELD	SPARE	READY TO WELD	READY TO WELD

Bits	Word 0		Word 1		Word 2		Word 3		Word 4		Word 5		Word 6		Word 7	
	Dec.	Octal	Spare Bits	Global (Enclosure) Bits	Spare Bits	Spare Bits	Spare Bits	Spare Bits	Spare Bits	Spare Bits	Weld Control Bits	Spare Bits	Spare Bits	Spare Bits	Spare Bits	Spare Bits
	08		SPARE	CONTACTOR IS OPEN	SPARE	SPARE	SPARE	SPARE	SPARE	SPARE	SPARE	SPARE	SPARE	SPARE	SPARE	SPARE
	09		SPARE	STEPPER APPROACHING MAXIMUM	SPARE	SPARE	SPARE	SPARE	SPARE	SPARE	WCU #4 STEPPER AP-PROACHING MAXIMUM	SPARE	SPARE	SPARE	SPARE	SPARE
	10		SPARE	SPARE	SPARE	SPARE	SPARE	SPARE	SPARE	SPARE	SPARE	SPARE	SPARE	SPARE	SPARE	SPARE
	11		SPARE	SPARE	SPARE	SPARE	SPARE	SPARE	SPARE	SPARE	SPARE	SPARE	SPARE	SPARE	SPARE	SPARE
	12		SPARE	Reserved ^a	SPARE	SPARE	SPARE	SPARE	SPARE	SPARE	SPARE	SPARE	SPARE	SPARE	SPARE	SPARE
	13		SPARE	NOT IN RUN MODE ^b	SPARE	SPARE	SPARE	SPARE	SPARE	SPARE	SPARE	SPARE	SPARE	SPARE	SPARE	SPARE
	14		SPARE	COMMUNICATIONS ERROR ^c	SPARE	SPARE	SPARE	SPARE	SPARE	SPARE	SPARE	SPARE	SPARE	SPARE	SPARE	SPARE
	15		SPARE	Reserved ^d	SPARE	SPARE	SPARE	SPARE	SPARE	SPARE	SPARE	SPARE	SPARE	SPARE	SPARE	SPARE

a. Reserved for RIO communication status.

b. Weld PLC Processor not in Run Mode.

c. Communications error between 3005 RIO Network Module and Host PLC.

d. Reserved for RIO communication status.

DeviceNet I/O Tables

.

dnet_map Welder Inputs—Node 30

Host Output Image Table (Node 30)

Bit	Global	SCR#1	SCR#2	SCR#3	SCR#4	SCR#5	SCR#6
Byte 0 ^a	Byte 1 ^b	Byte 2 ^b	Byte 3 ^b	Byte 4 ^b	Byte 5 ^b	Byte 6 ^b	Byte 7 ^b
00	ENABLE SCR#1	CONTROL STOP	BINARY SELECT #1	BINARY SELECT #1	BINARY SELECT #1	BINARY SELECT #1	BINARY SELECT #1
01	ENABLE SCR#2	ENABLE CONTACTOR SAVER	BINARY SELECT #2	BINARY SELECT #2	BINARY SELECT #2	BINARY SELECT #2	BINARY SELECT #2
02	ENABLE SCR#3	GLOBAL STEPPER RESET	BINARY SELECT #4	BINARY SELECT #4	BINARY SELECT #4	BINARY SELECT #4	BINARY SELECT #4
03	ENABLE SCR#4	GLOBAL FAULT RESET	BINARY SELECT #8	BINARY SELECT #8	BINARY SELECT #8	BINARY SELECT #8	BINARY SELECT #8
04	ENABLE SCR#5	SCR #1 TIPS DRESSED	BINARY SELECT #16	BINARY SELECT #16	BINARY SELECT #16	BINARY SELECT #16	BINARY SELECT #16
05	ENABLE SCR#6	SCR #2 TIPS DRESSED	INITIATE WELD	INITIATE WELD	INITIATE WELD	INITIATE WELD	INITIATE WELD
06	Reserved	MACHINE OUTPUT #1 ^c	WELD/NO WELD	WELD/NO WELD	WELD/NO WELD	WELD/NO WELD	WELD/NO WELD
07	Reserved	MACHINE OUTPUT #2 ^c	STEPPER RESET	STEPPER RESET	STEPPER RESET	STEPPER RESET	STEPPER RESET

- a. The I/O active will be set if the control slot is enabled and supported. The respective Byte 0 Input bit must be set for the control to be enabled. If the bit is not set, the respective device is not required to be in the SLC rack.
- b. For definitions of the signals in bytes 1-7, refer to “I/O Definitions” on page 3-5.
- c. The machine output will control a local output on the I/O card of the control. The status of this local machine output will directly reflect the status of the DeviceNet input.

dnet_map Welder Outputs—Node 30

Host Input Image Table (Node 30)							
Bit	Global	SCR#1	SCR#2	SCR#3	SCR#4	SCR#5	SCR#6
Byte 0 ^a	Byte 1 ^b	Byte 2 ^b	Byte 3 ^b	Byte 4 ^b	Byte 5 ^b	Byte 6 ^b	Byte 7 ^b
00	ID BIT #0 CONTACTOR IS OPEN	I/O ACTIVE	I/O ACTIVE	I/O ACTIVE	I/O ACTIVE	I/O ACTIVE	I/O ACTIVE
01	ID BIT #1 STEPPER APPROACHING LAST STEP	WELD IN PROGRESS	WELD IN PROGRESS	WELD IN PROGRESS	WELD IN PROGRESS	WELD IN PROGRESS	WELD IN PROGRESS
02	ID BIT #2 END OF STEPPER/END OF CAP LIFE	NO FAULT	NO FAULT	NO FAULT	NO FAULT	NO FAULT	NO FAULT
03	SIZE BIT #0 SPARE	ALERT	ALERT	ALERT	ALERT	ALERT	ALERT
04	SIZE BIT #1 SCR #1 TIP DRESS REQUEST	END OF STEPPER/END OF CAP LIFE	END OF STEPPER/END OF CAP LIFE	END OF STEPPER/END OF CAP LIFE	END OF STEPPER/END OF CAP LIFE	END OF STEPPER/END OF CAP LIFE	END OF STEPPER/END OF CAP LIFE
05	SIZE BIT #2 SCR #2 TIP DRESS REQUEST	STEPPER IS RESET	STEPPER IS RESET	STEPPER IS RESET	STEPPER IS RESET	STEPPER IS RESET	STEPPER IS RESET
06	SIZE BIT #3 MACHINE INPUT #1 ^c	WELD COMPLETE	WELD COMPLETE	WELD COMPLETE	WELD COMPLETE	WELD COMPLETE	WELD COMPLETE
07	SPARE	READY TO WELD	READY TO WELD	READY TO WELD	READY TO WELD	READY TO WELD	READY TO WELD

a. This byte is used to identify the application information that is to be sent by the scanner while operating in Slave mode. Bits #0-2 are used to identify the provider of the information. The following are currently defined providers and their ID numbers:

WTCID = 1 binary = (001)

ABBID = 2 binary = (010)

Bits #3-5 are used to identify the amount of information to be transferred. The size will be the amount of information to be transferred. The size will also indicate the amount of output bytes that contain actual data. (The input size will always equal the output size.) Bit #7 is currently a spare and should be filled with a 0.

b. For a definition of the signals in bytes 1-7, refer to “I/O Definitions” on page 3-5.

dnet_map Welder Inputs—Node 30

Host Output Image Table (Node 30)

Bit	Global	SCR# 7	SCR #8	SCR #9	SCR #10	SCR #11	SCR #12
	Byte 0^a	Byte 1^b	Byte 2^b	Byte 3^b	Byte 4^b	Byte 5^b	Byte 6^b
00	ENABLE SCR#7 Reserved	BINARY SELECT #1	BINARY SELECT #1	BINARY SELECT #1	BINARY SELECT #1	BINARY SELECT #1	BINARY SELECT #1
01	ENABLE SCR#8 Reserved	BINARY SELECT #2	BINARY SELECT #2	BINARY SELECT #2	BINARY SELECT #2	BINARY SELECT #2	BINARY SELECT #2
02	ENABLE SCR#9 Reserved	BINARY SELECT #4	BINARY SELECT #4	BINARY SELECT #4	BINARY SELECT #4	BINARY SELECT #4	BINARY SELECT #4
03	ENABLE SCR#10 Reserved	BINARY SELECT #8	BINARY SELECT #8	BINARY SELECT #8	BINARY SELECT #8	BINARY SELECT #8	BINARY SELECT #8
04	ENABLE SCR#11 Reserved	BINARY SELECT #16	BINARY SELECT #16	BINARY SELECT #16	BINARY SELECT #16	BINARY SELECT #16	BINARY SELECT #16
05	ENABLE SCR#12 Reserved	INITIATE WELD	INITIATE WELD	INITIATE WELD	INITIATE WELD	INITIATE WELD	INITIATE WELD
06	RESERVED	WELD/ NO WELD	WELD/ NO WELD	WELD/ NO WELD	WELD/ NO WELD	WELD/ NO WELD	WELD/ NO WELD
07	RESERVED	STEPPER RESET	STEPPER RESET	STEPPER RESET	STEPPER RESET	STEPPER RESET	STEPPER RESET

a. To activate the transfer of these inputs to SCR #n, (where n=1, 2, 3) the SCR #n Enable input must be set HIGH.

b. For a definition of these signals, refer to “I/O Definitions” on page 3-5.

dnet_map Welder Outputs—Node 30

Host Input Image Table (Node 30)											
Bit	Global	SCR#7	SCR#8	SCR#9	SCR#10	SCR#11	SCR#12				
Byte 0	Byte 1 ^b	Byte 2 ^b	Byte 3 ^b	Byte 4 ^b	Byte 5 ^b	Byte 6 ^b	Byte 7 ^b				
00	ID Bit #0 Reserved	I/O ACTIVE	I/O ACTIVE	I/O ACTIVE	I/O ACTIVE	I/O ACTIVE	I/O ACTIVE				
01	ID Bit #1 Reserved	WELD IN PROGRESS	WELD IN PROGRESS	WELD IN PROGRESS	WELD IN PROGRESS	WELD IN PROGRESS	WELD IN PROGRESS				
02	ID Bit #2 Reserved	NO FAULT	NO FAULT	NO FAULT	NO FAULT	NO FAULT	NO FAULT				
03	SIZE BIT #0 Reserved	ALERT	ALERT	ALERT	ALERT	ALERT	ALERT				
04	SIZE BIT #1 Reserved	END OF STEPPER/END OF CAP LIFE	END OF STEPPER/END OF CAP LIFE	END OF STEPPER/END OF CAP LIFE	END OF STEPPER/END OF CAP LIFE	END OF STEPPER/END OF CAP LIFE	END OF STEPPER/END OF CAP LIFE				
05	SIZE BIT #2 Reserved	STEPPER IS RESET	STEPPER IS RESET	STEPPER IS RESET	STEPPER IS RESET	STEPPER IS RESET	STEPPER IS RESET				
06	SIZE BIT #3 Reserved	WELD COMPLETE	WELD COMPLETE	WELD COMPLETE	WELD COMPLETE	WELD COMPLETE	WELD COMPLETE				
07	SPARE Reserved	READY TO WELD	READY TO WELD	READY TO WELD	READY TO WELD	READY TO WELD	READY TO WELD				

Note: The above information will be located in the SLC image table of the Scanner slot beginning with word #1. (i.e., If the scanner is located in slot #2, word 0 will contain the status/control information, word #1 will contain bytes 0 & 1, word #2 will contain bytes 2 & 3, etc.)

dnet1_map Welder Inputs—Node 30

Host Output Image Table (Node 30)						
Bit	HBit Input Word 0 ^a	HBit Input Word 1 ^a	HBit Input Word 2 ^a	HBit Input Word 3 ^a	HBit Input Word 4 ^a	
00	MODULE STATUS REGISTER	16 Enable SCR#1	32 SCR #1 BINARY SELECT #1	48 PART ID LSW (Bit 00)	64 PART ID MSW (Bit 00)	
01	MODULE STATUS REGISTER	17 Enable SCR#2	33 SCR #1 BINARY SELECT #2	49 PART ID LSW (Bit 01)	65 PART ID MSW (Bit 01)	
02	MODULE STATUS REGISTER	18 <i>Unused</i>	34 SCR #1 BINARY SELECT #4	50 PART ID LSW (Bit 02)	66 PART ID MSW (Bit 02)	
03	MODULE STATUS REGISTER	19 <i>Unused</i>	35 SCR #1 BINARY SELECT #8	51 PART ID LSW (Bit 03)	67 PART ID MSW (Bit 03)	
04	MODULE STATUS REGISTER	20 <i>Unused</i>	36 SCR #1 BINARY SELECT #16	52 PART ID LSW (Bit 04)	68 PART ID MSW (Bit 04)	
05	MODULE STATUS REGISTER	21 <i>Unused</i>	37 SCR #1 INITIATE WELD	53 PART ID LSW (Bit 05)	69 PART ID MSW (Bit 05)	
06	MODULE STATUS REGISTER	22 TRANSFER NEW PART ID TO SCR #1	38 SCR #1 WELD/ NO WELD	54 PART ID LSW (Bit 06)	70 PART ID MSW (Bit 06)	
07	MODULE STATUS REGISTER	23 TRANSFER NEW PART ID TO SCR #2	39 SCR #1 STEPPER RESET	55 PART ID LSW (Bit 07)	71 PART ID MSW (Bit 07)	

a. For definition of the signals in words 1-4, refer to “I/O Definitions” on page 3-5.

Host Output Image Table (Node 30)

Bit	HBit Input Word 0	HBit Input Word 1 ^a	HBit Input Word 2 ^a	HBit Input Word 3 ^a	HBit Input Word ^a
08	MODULE STATUS REGISTER	24 GLOBAL CONTROL STOP	40 SCR #2 BINARY SELECT #1	56 PART ID LSW (Bit 08)	72 PART ID MSW (Bit 08)
09	MODULE STATUS REGISTER	25 GLOBAL ENABLE CONTACTOR SAVER	41 SCR #2 BINARY SELECT #2	57 PART ID LSW (Bit 09)	73 PART ID MSW (Bit 09)
10	MODULE STATUS REGISTER	26 GLOBAL STEPPER RESET	42 SCR #2 BINARY SELECT #4	58 PART ID LSW (Bit 10)	74 PART ID MSW (Bit 10)
11	MODULE STATUS REGISTER	27 GLOBAL FAULT RESET	43 SCR #2 BINARY SELECT #8	59 PART ID LSW (Bit 11)	75 PART ID MSW (Bit 11)
12	MODULE STATUS REGISTER	28 SCR #1 TIP DRESSED	44 SCR #2 BINARY SELECT #16	60 PART ID LSW (Bit 12)	76 PART ID MSW (Bit 12)
13	MODULE STATUS REGISTER	29 SCR #2 TIP DRESSED	45 SCR #2 INITIATE WELD	61 PART ID LSW (Bit 13)	77 PART ID MSW (Bit 13)
14	MODULE STATUS REGISTER	30 LOCAL MACHINE OUTPUT #1	46 SCR #2 WELD/ NO WELD	62 PART ID LSW (Bit 14)	78 PART ID MSW (Bit 14)
15	MODULE STATUS REGISTER	31 LOCAL MACHINE OUTPUT #2	47 SCR #2 STEPPER RESET	63 PART ID LSW (Bit 15)	79 PART ID MSW (Bit 15)

dnet1_map Welder Outputs—Node 30

Host Input Image Table (Node 30)						
Bit	HBit Output Word 0 ^a	HBit Output Word 1 ^b	HBit Output Word 2 ^b	HBit Output Word 3 ^b	HBit Output Word 4	
00	MODULE STATUS REGISTER	16 ID BIT #0	32 SCR #1 I/O ACTIVE	48 ACTIVE PART ID LSW (Bit 00)	64 ACTIVE PART ID MSW (Bit 00)	
01	MODULE STATUS REGISTER	17 ID BIT #1	33 SCR #1 WELD IN PROGRESS	49 ACTIVE PART ID LSW (Bit 01)	65 ACTIVE PART ID MSW (Bit 01)	
02	MODULE STATUS REGISTER	18 ID BIT #2	34 SCR #1 NO FAULT	50 ACTIVE PART ID LSW (Bit 02)	66 ACTIVE PART ID MSW (Bit 02)	
03	MODULE STATUS REGISTER	19 SIZE BIT #0	35 SCR #1 ALERT	51 ACTIVE PART ID LSW (Bit 03)	67 ACTIVE PART ID MSW (Bit 03)	
04	MODULE STATUS REGISTER	20 SIZE BIT #1	36 SCR #1 END OF STEPPER	52 ACTIVE PART ID LSW (Bit 04)	68 ACTIVE PART ID MSW (Bit 04)	
05	MODULE STATUS REGISTER	21 SIZE BIT #2	37 SCR #1 STEPPER IS RESET	53 ACTIVE PART ID LSW (Bit 05)	69 ACTIVE PART ID MSW (Bit 05)	
06	MODULE STATUS REGISTER	22 SIZE BIT #3	38 SCR #1 WELD COMPLETE	54 ACTIVE PART ID LSW (Bit 06)	70 ACTIVE PART ID MSW (Bit 06)	
07	MODULE STATUS REGISTER	23 GLOBAL DOWNLOAD OF PART # IN PROGRESS	39 SCR #1 READY TO WELD	55 ACTIVE PART ID LSW (Bit 07)	71 ACTIVE PART ID MSW (Bit 07)	

a. The I/O active will be set if the control slot is enabled and supported. The respective Byte 0 Output bit must be set for the control to be enabled. If the bit is not set, the respective device is not required to be in the SLC rack.

b. For definition of the signals in words 1-4, refer to ‘I/O Definitions’ on page 3-5.

Host Input Image Table (Node 30)

Bit	HBit Output Word 0 ^a	HBit Output Word 1 ^b	HBit Output Word 2 ^b	HBit Output Word 3 ^b	HBit Output Word 4 ^b
08	MODULE STATUS REGISTER	24 Global CONTACTOR IS OPEN	40 SCR #2 I/O ACTIVE	48 ACTIVE PART ID LSW (Bit 00)	72 ACTIVE PART ID MSW (Bit 00)
09	MODULE STATUS REGISTER	25 Global STEPPER APPROACHING MAXIMUM	41 SCR #2 WELD IN PROGRESS	49 ACTIVE PART ID LSW (Bit 01)	73 ACTIVE PART ID MSW (Bit 01)
10	MODULE STATUS REGISTER	26 Global END OF STEPPER	42 SCR #2 NO FAULT	50 ACTIVE PART ID LSW (Bit 02)	74 ACTIVE PART ID MSW (Bit 02)
11	MODULE STATUS REGISTER	27 Global ERROR IN PART # DOWN-LOAD	43 SCR #2 ALERT	51 ACTIVE PART ID LSW (Bit 03)	75 ACTIVE PART ID MSW (Bit 03)
12	MODULE STATUS REGISTER	28 SCR #1 TIP DRESS REQUEST	44 SCR #2 END OF STEPPER	52 ACTIVE PART ID LSW (Bit 04)	76 ACTIVE PART ID MSW (Bit 04)
13	MODULE STATUS REGISTER	29 SCR #2 TIP DRESS REQUEST	45 SCR #2 STEPPER IS RESET	53 ACTIVE PART ID LSW (Bit 05)	77 ACTIVE PART ID MSW (Bit 05)
14	MODULE STATUS REGISTER	30 LOCAL MACHINE INPUT #1	46 SCR #2 WELD COMPLETE	54 ACTIVE PART ID LSW (Bit 06)	78 ACTIVE PART ID MSW (Bit 06)
15	MODULE STATUS REGISTER	31 LOCAL MACHINE INPUT #2	47 SCR #2 READY TO WELD	55 ACTIVE PART ID LSW (Bit 07)	79 ACTIVE PART ID MSW (Bit 07)

a. The I/O active will be set if the control slot is enabled and supported. The respective Byte 0 Output bit must be set for the control to be enabled. If the bit is not set, the respective device is not required to be in the SLC rack.

b. For definition of the signals in words 1-4, refer to ‘I/O Definitions’ on page 3-5.